

30.5 mm Push Buttons

- Bulletin 800T/800H **Page 10-2**

22.5 mm Push Buttons

- Bulletin 800F **Page 10-66**
- Bulletin 800FC Configured Pendant Stations **Page 10-127**
- Bulletin 800FD Monolithic **Page 10-140**
- Bulletin 800M **Web†**

16 mm Push Buttons

- Bulletin 800B **Page 10-146**

Specialty Push Buttons

Hazardous Location Push Buttons

- Bulletin 800H Type 7 & 9 **Page 10-152**
- Bulletin 800R **Page 10-189**
- Bulletin 800G **Page 10-194**

Touch/Palm Push Buttons

- Bulletin 800P Palm Operated **Page 10-210**
- Bulletin 800Z Zero-Force™ **Page 10-214**

Miscellaneous Push Buttons

- Bulletin 800L Indicators **Page 10-221**
- Bulletin 800H Security Stations **Web†**
- Bulletin 800S Stations **Page 10-223**

† Information for this product line is available on the Industrial Controls Catalog website: www.ab.com/catalogs.



Bulletin 800T/800H 30.5 mm Push Buttons

- 30.5 mm mounting hole
- Type 4/13 watertight/oiltight (Bul. 800T)
- Type 4/4X/13 corrosion-resistant/watertight/oiltight (Bul. 800H)
- Heavy industrial stations and operators

Description

The Allen-Bradley Bulletin 800T and 800H 30.5 mm push button product lines are in a class by themselves. They are designed and constructed to perform in the most demanding industrial environments. In terms of sealing and switching performance, you will not find a more dependable push button offering. Allen-Bradley delivers more styles and options of operator types and contact blocks, offering flexibility to meet the most demanding specifications in the world's toughest industrial environments.

Design innovation is key to the performance advantage provided in the Bulletin 800T and 800H offerings. New in this catalog are the **Trigger Action E-Stop** operators, the new standard bearer in a tamper-resistant design. Also new is the **Universal LED Illumination** option that accepts a wide 12...130V AC/DC voltage input. This is compatible with all illuminated operator types, allows retrofitting in existing installations, and incorporates super bright LED technology.

Table of Contents

See below.

Standards Compliance

UL 508

CCC

Certifications

UL Listed
 (File No. E14840, E10314
 Guide No. NKCR, NOIV)

CSA Certified
 (File No. LR1234, LR11924)

CSA C22.2, No. 14

EN/IEC: 60947-5-1

TABLE OF CONTENTS

Description	Page
Specifications	10-3
Assembled Stations	10-5
DeviceNet Stations	10-6
Trigger Action E-Stops	10-7
Push Buttons, Momentary	
Non-Illuminated	10-9
Illuminated	10-10
Non-Illuminated — with Two-Color Molded Legend Cap	10-11
Selector Switches, Non-Illuminated	
2-Position	10-12
3-Position	10-14
4-Position	10-16
Selector Switches, Illuminated	
2-Position	10-18
3-Position	10-19
Pilot Light Devices	10-20
Emergency Stop Operators	
Push-Pull, Non-Illuminated	
2-Position	10-21
3-Position	10-22
Push-Pull, Illuminated	
2-Position	10-23
3-Position	10-24

Description	Page
Specialty Operators	
Potentiometer	10-25
Mechanically Interlocked Push Button	10-25
Cluster Pilot Light	10-26
18 mm Small Pilot Light	10-27
1-, 2-, 3-, 4-Way Toggle Switch	10-28
Selector Push Button	10-29
Cylinder Lock Push Button	10-30
Padlocking Mushroom Head	10-30
Wobble Stick	10-30
Flip Lever Operator	10-31
Break-Glass Push Button Station	10-32
Custom-Built Stations	10-33
Enclosures	10-33
Accessories	
Contact Blocks	10-35
Power Modules and Universal LED Module	10-36
Replacement Color Caps	10-37
Selector Switch Knobs	10-38
Protective Boots	10-39
Push Buttons & Miscellaneous	10-40
Locking Attachments	10-42
Guards	10-44
Replacement Lamps	10-45
Replacement Keys	10-46
Legend Plates	10-47
Approximate Dimensions & Shipping Weights	10-53
Typical Pilot Light Wiring Diagram	10-65



Specifications*

Electrical Ratings		
Contact ratings	Refer to the contact ratings tables on page 10-4.	
Dielectric strength	2200V for one minute, 1300V for one minute (Logic Reed)	
Electrical design life cycles	1 000 000 at max. rated load, 200 000 at max. rated load (Logic Reed)	
Mechanical Ratings		
Vibration	10...2000 Hz, 1.52 mm displacement (peak-to-peak) max./ 10 G max. (except Logic Reed)	
Shock	1/2 cycle sine wave for 11 ms \geq 25 G (contact fragility) and no damage at 100 G	
Degree of protection	Type 1/4/12/13 (800T); Type 1/4/4X/12/13 (800H); EN/IEC 60529 IP66/65	
Mechanical design life cycles		
Push buttons	(Momentary, non-illuminated)	10 000 000 min.
	(Momentary, illuminated)	250 000 min.
	(Push-pull/twist-to-release)	250 000 min.
Selector switches	(Non-illuminated)	1 000 000 min.
	(Illuminated, key-operated)	200 000 min.
Potentiometers	25 000 min.	
All other devices	200 000 min.	
Contact operation	Shallow, mini, and low-voltage contact blocks: Slow, double make and break Logic Reed and sealed switch contact blocks: Single break magnetic	
Wire gauge/Terminal screw torque	#18...14 AWG (#18...10 Max Duty) / 6...8 lb•in	
Typical operating forces		
Operators without contact blocks	Flush, extended button, standard mushroom, jumbo plastic mushroom: 2 lbs max. Jumbo and extended aluminum mushroom head: 3.95 lbs max. Maintained selector switch: 3.6 in•lb max.	
Spring return selector switches	3.6 in•lb to stop, 0.2 in•lb to return	
Illuminated push buttons and push-to-test pilot lights	5 lb max.	
2-position push-pull	8.0 lb max. push or pull	
3-position push-pull	8 lb max. push to in position or pull to center position (15 lb max. pull to out position)	
Twist-to-release or push-pull	9 lbs max. push or pull 30 in•oz max. twist, 6 in•oz minimum return	
Potentiometer	Rotational torque 3...12 in•oz; stopping torque 12 in•lb (minimum)	
Contact blocks	Standard	1 lb
	Logic Reed	1 lb max.
	Sealed switch	3 lb max. at 0.205 in. plunger travel
	Stackable sealed switch	1 lb max.
	MaxDuty	1.4 lb max.
	PenTUFF	1.4 lb max.
Self Monitoring	1.6 lb	
Environment		
Temperature range	Operating	-40...+131 °F (-40...+55 °C)
	Storage	-40...+185 °F (-40...+85 °C)
Note: Operating temperatures below freezing are based on the absence of moisture and liquids. Consult your local Rockwell Automation sales office or Allen-Bradley distributor for use in lower temperature applications.		
Humidity	50...95% RH from 77...140 °F (25...60 °C) per Procedure IV of MIL-STD-810C, Method 507.1 cycling test	

* Performance Data — See Important- 3.

30.5 mm Push Buttons

Specifications

Standard Contact Ratings

Minimum: 24V, 24 mA

Maximum thermal continuous current I_{th} 10 A AC/2.5 A DC. Bulletin 800T units with 800T-XA contacts have ratings as follows:

Max. Operntl. Volts U_e	Utilization Category		Rated Operational Currents		
	IEC	NEMA	Volts U_e	Make	Break
AC 600	AC-15	A600	120...600	7200VA	720VA
			72...120	60 A	720VA
			24...72	60 A	10 A
DC 600	DC-13	Q600	28...600	69VA	
			24...28*	2.5 A	

* For applications below 24V/24 mA, PenTUFF or Logic Reed contacts are recommended.

Sealed Switch Contact Ratings

Minimum: 5V, 1 mA

Maximum continuous current I_{th} 5 A. Bulletin 800T units have control circuit ratings with sealed switch contact blocks as follows:

Max. Operntl. Volts U_e	Utilization Category		Rated Operational Currents		
	IEC	NEMA	Volts U_e	Make	Break
AC 600	AC-15	B600	120...600	3600VA	360VA
			0...120	30 A	3 A
DC 300	DC-13	P300	24...300	138VA	
			0...24	5.0 A	

Stackable Sealed Switch Contact Ratings

Minimum: 5V, 10 mA (digital); 24V, 1 mA (analog)

Maximum continuous current I_{th} 2.5 A. Bulletin 800T units have control circuit ratings with sealed switch contact blocks as follows:

Max. Operntl. Volts U_e	Utilization Category		Rated Operational Currents		
	IEC	NEMA	Volts U_e	Make	Break
AC 300	AC-15	C300	120...300	1800VA	180VA
			0...120	15 A	1.5 A
DC 150	DC-13	Q150	24...150	69VA	
			0...24	2.5 A	

Logic Reed Contact Ratings

Minimum — DC: 5V, 1 mA

Maximum — DC: 30V, 0.06 A, AC: 150V, 0.15 A

Should only be used with resistive loads.

Materials Used in 800H Type 4X Operators

Thermoplastic Polyester (Fiberglass Reinforced)

- Bushings
- Mounting Rings
- Sockets

Thermoplastic Polyester

- Non-illuminated button caps

Transparent Amorphous Nylon

- Pilot light lens cap
- Illuminated button caps

Glass Filled Crystalline Nylon

- Thrust washer

Mineral Filled Nylon

- Trim washer

Nitrile (Synthetic Rubber)

- Gaskets and internal seals

PenTUFF™ (Low Voltage) Contact Ratings

Minimum DC: 5V, 1 mA

Maximum thermal continuous current I_{th} 2.5 A AC/1.0 A DC. Bulletin 800T units with 800T-XAV contacts have ratings as follows:

Max. Operntl. Volts U_e	Utilization Category		Rated Operational Currents		
	IEC	NEMA	Volts U_e	Make	Break
AC 300	AC-15	C300	120...300	1800VA	180VA
			0...120	15 A	1.5 A
DC 150	DC-13	R150	24...150	28VA	
			0...24	1.0 A	

Snap Action Contact Ratings

Max. Operntl. Volts U_e	Contact Rating Designation	Rated Operational Currents		
		Volts U_e	Make	Break
AC 300	A300	120...300	7200VA	720VA
		24...72	60 A	10 A
DC 250	—	230...250	0.2 A	
		115...125	0.4 A	

MaxDuty Contact Rating

Maximum thermal continuous current I_{th} 24 A.

Pilot Duty — 120V AC, 12 A; 24V DC, 10 A

Motor Ratings — 120V AC, 1.5 Hp; 240V AC, 3 Hp; 24V DC, 10 A FLA/60 A LRA

Time Delay Contacts

Max. Operntl. Volts U_e	Contact Rating Designation	Rated Operational Currents		
		Volts U_e	Make	Break
AC 120	B150	120	3600VA	360VA

Note: This device is not rated for DC applications.

Adjustment range: 0.5...15 s \pm 25% I_{th} = 5 A

Product Selection
 Assembled Stations



Die Cast Aluminum
 Cat. No. **800T-2TAR**



Booted Operator – Stainless Steel
 Cat. No. **800H-1HA4T**



Booted Operator – Glass Polyester
 Cat. No. **800H-1HA4R**

Operator	Contact Symbol	Contact Action	Button Type	Button Color	Legend Marking	Type 4/13	Type 4/4X/13	
						Die Cast Aluminum Cat. No.	Booted Operator – Stainless Steel Cat. No.*	Booted Operator – Glass Polyester Cat. No.*
One Push Button		Momentary	Extended	Red	STOP	800T-1TA	800H-1HA4T	800H-1HA4R
		Momentary	Flush	Green	START	800T-1TB	800H-1HB4T	800H-1HB4R
		Momentary	Flush	Black	No Legend	800T-1TX	800H-1HX4T	800H-1HX4R
Two Push Buttons		Momentary	Flush Extended	Green Red	START STOP	800T-2TA	800H-2HA4T	800H-2HA4R
		Momentary	Flush Flush	Black Black	No Legend	800T-2TX	800H-2HX4T	800H-2HX4R
One Pilot Light, Two Push Buttons		Momentary	120V AC Flush Extended	Red Green Red	No Legend START STOP	800T-2TAR	800H-2HAR4T	800H-2HAR4R
		Momentary	120V AC Flush Flush	Red Black Black	No Legend	800T-2TXR	800H-2HXR4T	800H-2HXR4R
3-Position Selector Switch		Maintained	Knob Lever	Black with white insert	HAND-OFF-AUTO	800T-R3TA	—	—
		Maintained	Knob Lever	Black with white insert	No Legend	800T-R3TX	—	—
One Push Button		Maintained	Push-Pull/Twist	Red	EMERG STOP	800T-1TYM*	—	—
Two Push Buttons		Maintained	Flush Extended	Green Red	START STOP	800T-2TAM	800H-2HAM4T	800H-2HAM4R
		Maintained	Flush Flush	Black Black	No Legend	800T-2TXM	800H-2HXM4T	800H-2HXM4R

* Boot material is chlorosulfonated polyethylene. Add suffix **L** to the cat. no. for station with bootless operators. Example: **Cat. No. 800H-1HB4T** becomes **Cat. No. 800H-1HB4TL**.

* Supplied with yellow legend plate to comply with IEC 60947-5-5 and NFPA79 E-Stop standards that require yellow background.

DeviceNet Stations

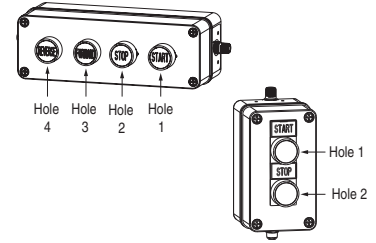

Two-Unit

800T –

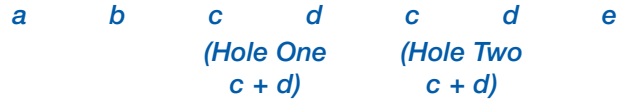

Three-Unit

800T –

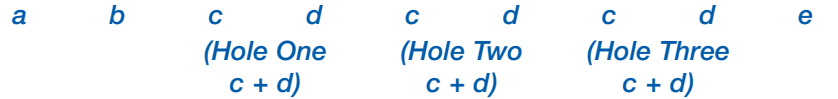

Four-Unit

800T –

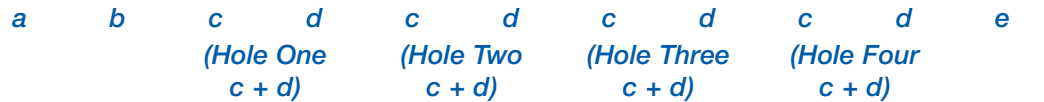

a

Orientation	
Code	Description
V	Vertical
H	Horizontal

b

Enclosure Style		
Grey Code	Description	Yellow Code
A	2-hole	K
B	3-hole	L
C	4-hole	M
G	E-stop only§	N

c

Operator Types	
Code	Description
A	Non-illuminated flush (800T-A*)
B	Non-illuminated extended (800T-B*)
C	Non-illuminated mushroom (800T-D*)
D	Illuminated mushroom (800T-QM*)
E	Illuminated extended (800T-QB*)
F	Illuminated guarded (800T-QA*)
G	2-position SS maintained (800T-H2*)
H	3-position SS maintained (800T-J2*)
J	Enhanced pilot light (800T-QH*)
K	Non-illuminated 2-position push/pull (800T-FX*)‡
L	Non-illuminated push/pull twist-to-release (800T-FXT*)‡
M	Illuminated 2-position push/pull (800T-FXQH*)
N	2-position key SS (800T-H33*)*
P	3-position key SS (800T-J44*)*
Q	2-position SS spring return from right (800T-H5*)
R	3-position SS spring return from all (800T-J91*)
T	Illuminated 2-position SS maintained (800T-24H*)
U	Illuminated 3-position SS maintained (800T-24J*)
V	Non-illuminated 3-position push/pull (800T-FXM*)
W	Potentiometer‡

d

Color/Text	
Code	Description
1	Green
2	Black (non-illuminated only)
3	Orange (non-illuminated only)
4	Grey (non-illuminated only)
5	White
6	Red
7	Blue
8	Clear (illuminated only)
9	Yellow (non-illuminated)/amber (illuminated)
A	Green with Start legend
B	Red with Stop legend
C	Red with E-Stop legend
D	Black with Off/On legend
E	Black with Hand/Off/Auto legend
F	Red with Push to Stop/Pull to Start legend
G	Blue with Reset legend
H	Red with Power On legend
X	N/A (i.e. key ss)

e

External I/O Version>	
Code	Description
Blank	No external I/O
A	1 input/1 output (sinking)
B	1 input/1 output (sourcing)
C	2 input
D	2 output (sinking)
E	2 output (sourcing)
F	1 E-stop block*
G	2 E-stop blocks*
H	2 input + 2 output
J	2 input + 2 output (sinking)
K	2 input + 2 output (sourcing)
L	1 input/1 output (sinking) + 1 E-stop block*
M	1 input/1 output (sourcing) + 1 E-stop block*
N	1 input/1 output (sinking) + 2 E-stop blocks*
P	1 input/1 output (sourcing) + 2 E-stop blocks*
Q	2 input + 1 E-stop block*
R	2 input + 2 E-stop blocks*
T	2 output (sinking) + 1 E-stop block*
U	2 output (sourcing) + 1 E-stop block*
V	2 output (sinking) + 2 E-stop blocks*
W	2 output (sourcing) + 2 E-stop blocks*
X	2 input + 1 input/1 output (sinking)
Y	2 input + 1 input/1 output (sourcing)

* Operator Types N and P from Table c must choose Color/Text option X from Table d.
 ‡ Operator Types K and L from Table c may be used as Emergency Stops. To be valid as an E-Stop, the operators must use Color/Text option C from Table d and it must be placed in the last hole position in the enclosure. An E-Stop connector also must be chosen from Table e.
 § Enclosure Style option G from Table b can only select one operator from Table c. Valid options are K and L with E-Stop.
 * External I/O Versions F, L, M, Q, T and U receive only one contact block for the external E-Stop string. These connectors are rated to 3 A. If more than 3 A of current is needed or if there are two E-Stop strings, use External I/O Versions G, N, P, R, V, and W. These versions receive two contact blocks. This allows for 6 A of switching or for two E-Stop strings.
 > This is an 8-in/4-out device. 2-in/1-out is assigned to each hole position in the enclosure. If a 2-hole enclosure is selected, 4-in and 2-out are assigned internally and up to 4 unassigned I/O points can be assigned to external connectors. This device contains up to two physical external I/O connectors. The "+" symbol in the Description field of Table e indicates that two external connectors exist. If an E-Stop connector is used, 2 unassigned I/O points can be assigned to the other connector.
 ‡ Available for certain applications, please contact your local Allen-Bradley distributor.

2-Position Red Trigger Action Twist-to-Release, Non-Illuminated

- Tamper resistant – front-of-panel mounting and non-removable operator head
- Compliant with global E-stop standards, including EN ISO 13850 and EN 60947-5-5



Cat. No. 800T-TFXJET6



Cat. No. 800T-TFXLET6



Cat. No. 800T-TFXK6



Cat. No. 800H-TFRXT6

Contact Type	Operator Position		Type 4/13			Type 4/4X/13
			45 mm Plastic	63 mm Metal	Key Release	45 mm Plastic
	Out	In	Cat. No.* ‡	Cat. No.* §	Cat. No.* ♣	Cat. No.* ‡
No contacts	—	—	800T-TFXT6	800T-TFXLT6	800T-TFXK6	800H-TFRXT6
1 N.C.	X	O	800T-TFXT6D2	800T-TFXLT6D2	800T-TFXK6D2	800H-TFRXT6D2
1 N.O. - 1 N.C.	O X	X O	800T-TFXT6A	800T-TFXLT6A	800T-TFXK6A	800H-TFRXT6A
1 S.M.C.B.➤	X	O	800TC-TFXT6D4S	800TC-TFXLT6D4S	800TC-TFXK6D4S	800HC-TFRXT6D4S

* For finger-safe contact block terminals, add a **C** to the cat. no. Example: Cat. No. 800TC-TFXT6 or 800HC-TFRXT6.

‡ To order a device with a jumbo (60 mm) plastic head add the letter **J** after **X**. Example: Cat. No. 800T-TFXJT6A or 800H-TFRXT6A.

§ To order a device with "E-STOP" engraved on the cap add the letter **E** after **L**. Example: Cat. No. 800TC-TFXLET6D4S.

♣ Provided with two DO18 keys.
 ➤ Self-monitoring contact block.



Protection Rating	
Code	Description
T	Metal, Type 4/13
H	Plastic, Type 4/4X/13

Finger-Safe Guards	
Code	Description
Blank	No guards
C	Guards on terminals

Head Type‡		
800T Type 4/13	Description	800H Type 4/4X/13
Code		Code
FX	Standard (45 mm) mushroom head	FRX
FXJ	Jumbo (60 mm) mushroom head	FRXJ
FXJE	Jumbo (60 mm) mushroom head with "E-STOP"	FRXJE
FXK	45 mm mushroom head key release	—
FXL	63 mm anodized aluminum head	—
FXLE	63 mm anodized aluminum head with "E-STOP"	—

Release Function	
Code	Color
Blank	Key release $\%$
T	Twice release

Note: X = Closed/O = Open
 $\%$ Configurable only with **FXK** head type.

Contact Block(s)			
Code	Operator Position		Description
Blank	—	—	No contacts on operator
Standard			
D1	O	X	1 N.O.
D2	X	O	1 N.C.
D4	X	O	1 N.C.L.B.
A	O X	X O	1 N.O. - 1 N.C.
A1	O X	X O	1 N.O. - 1 N.C.L.B.
A5	X X	O O	2 N.C.L.B.
PenTUFF (Low Voltage)			
D1V	O	X	1 N.O.
D2V	X	O	1 N.C.
D4V	X	O	1 N.C.L.B.
AV	O X	X O	1 N.O. - 1 N.C.
Class 1, Div. 2/Zone 2			
Logic Reed			
D1R	O	X	1 N.O.
D2R	X	O	1 N.C.
AR	O X	X O	1 N.O. - 1 N.C.
Sealed Switch			
D1P	O	X	1 N.O.
D2P	X	O	1 N.C.
AP	O X	X O	1 N.O. 1 N.C.
Stackable Sealed Switch			
D1Y	O	X	1 N.O.
D2Y	X	O	1 N.C.
AY	O X	X O	1 N.O. - 1 N.C.



Bulletin 800T/H
30.5 mm Push Buttons
 Emergency Stop Operators

2-Position Red Trigger Action Twist-to-Release, Illuminated

- Tamper resistant – front-of-panel mounting and non-removable operator head
- Compliant with global E-stop standards, including EN ISO 13850 and EN 60947-5-5
- LED illumination provided as standard

Type	Volts	Contacts	Operator Position		Type 4/13		Type 4/4X/13	
			Out	In	45 mm*	60 mm**	45 mm*	60 mm**
Operator only†			No contacts		800T-TFXTS00R	800T-TFXJTS00R	800H-TFRXTS00R	800H-TFRXJTS00R
Universal	12...130V AC/DC	N.O. - N.C.	O	X	800T-TFXTQH2RA	800T-TFXJTQH2RA	800H-TFRXTQH2RA	800H-TFRXJTQH2RA
Transformer	120V AC 50/60 Hz		X	O	800T-TFXTPH16RA	800T-TFXJTPH16RA	800H-TFRXTPH16RA	800H-TFRXJTPH16RA

Note: X = Closed/O = Open

* For finger-safe contact block terminals, add a **C** to the cat. no. Example: Cat. No. 800TC-TFXTS00R or 800HC-TFRXTS00R.

** To order a device with "E-STOP" printed on the cap add the letter **E** after **J**. Example: Cat. No. 800T-TFXJETQH2RA or 800H-TFRXJETQH2RA.

† Operator-only supplied without power module, lamp, or contact blocks.

800 **T** - **T** **FXT** **QH** **2** **R** **A**
 a **b** **c** **d** **e** **f**

a

Protection Rating	
Code	Description
T	Metal, Type 4/13
H	Plastic, Type 4/4X/13

b

Finger-Safe Guards	
Code	Description
Blank	No guards
C	Guards on terminals

c

Head Type§		
800T Type 4/13	Description	800H Type 4/4X/13
Code		Code
FXT	Standard (45 mm) mushroom head	FRXT
FXJT	Jumbo (60 mm) mushroom head	FRXJT
FXJET	Jumbo (60 mm) mushroom head with "E-STOP"	FRXJET



d

Illumination Option	
Code	Description
PH	Transformer with LED lamp
QH	Universal with LED lamp

e

Voltage	
Transformer	
Code	Description
16	120V AC 50/60 Hz
26	240V AC 50/60 Hz
46	480V AC 50/60 Hz
56	600V AC 50/60 Hz
Universal	
Code	Description
2	12...130V AC/DC

f

Target		
Contact		
N.O.	O	X
N.C./N.C.L.B.	X	O
Contact Blocks		
Code	Description	
Blank	No contacts	
Standard		
D1	1 N.O.	
D2	1 N.C.	
D4	1 N.C.L.B.	
A	1 N.O. - 1 N.C.	
A1	1 N.O. - 1 N.C.L.B.	
A5	2 N.C.L.B.	
PenTUFF (Low Voltage)		
D1V	1 N.O.	
D2V	1 N.C.	
D4V	1 N.C.L.B.	
AV	1 N.O. - 1 N.C.	
Class 1, Div. 2/Zone 2		
Logic Reed		
D1R	1 N.O.	
D2R	1 N.C.	
AR	1 N.O. - 1 N.C.	
Sealed Switch		
D1P	1 N.O.	
D2P	1 N.C.	
AP	1 N.O. - 1 N.C.	
Stackable Sealed Switch		
D1Y	1 N.O.	
D2Y	1 N.C.	
AY	1 N.O. - 1 N.C.	

Momentary Contact Push Button Devices, Non-Illuminated



Flush Head Unit
 Cat. No. 800T-A1A



Extended Head Unit
 Cat. No. 800T-B6A



Booted Unit
 Cat. No. 800H-R2A



Bootless Flush Head Unit
 Cat. No. 800H-AR1A

Contact Type	Button Color	Type 4/13		Type 4/4X/13	
		Flush Head	Extended Head	Booted*	Bootless Flush Head
		Cat. No.	Cat. No.	Cat. No.	Cat. No.
No Contact	Green	800T-A1	800T-B1	800H-R1	800H-AR1
	Black	800T-A2	800T-B2	800H-R2	800H-AR2
	Red	800T-A6	800T-B6	800H-R6	800H-AR6
1 N.O.	Green	800T-A1D1	800T-B1D1	800H-R1D1	800H-AR1D1
	Black	800T-A2D1	800T-B2D1	800H-R2D1	800H-AR2D1
	Red	800T-A6D1	800T-B6D1	800H-R6D1	800H-AR6D1
1 N.C.	Green	800T-A1D2	800T-B1D2	800H-R1D2	800H-AR1D2
	Black	800T-A2D2	800T-B2D2	800H-R2D2	800H-AR2D2
	Red	800T-A6D2	800T-B6D2	800H-R6D2	800H-AR6D2
1 N.O. - 1 N.C.	Green	800T-A1A	800T-B1A	800H-R1A	800H-AR1A
	Black	800T-A2A	800T-B2A	800H-R2A	800H-AR2A
	Red	800T-A6A	800T-B6A	800H-R6A	800H-AR6A

800 T - A 1 A
 a b c d e f

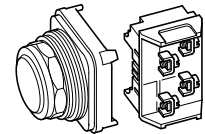

a

Protection Rating	
Code	Description
T	Metal, Type 4/13
H	Plastic, Type 4/4X/13

b

Finger-Safe Guards	
Code	Description
Blank	No guards
C	Guards on terminals

c

Operator Type		
800T Type 4/13	Description	800H Type 4/4X/13
Code		Code
A	Flush head	AR
B	Extended head	BR
D	Mushroom head	DR
DX	Mushroom head less color cap	DRX
—	Bootless guarded head	GR
—	Booted head	R*

d

Color Cap	
Code	Description
Blank	Used only when ordering Operator Type DX/DRX
1	Green
2	Black
3	Orange*

d (cont'd)

Color Cap	
Code	Description
4	Grey*
5	White*
6	Red
7	Blue
9	Yellow

e

Special Mushroom Head	
Code	Description
J§	Jumbo mushroom head — plastic
L§	Jumbo mushroom head — metal

Note: Special mushroom head options only apply to mushroom head operator type code D/DR (Table c).

f

Contact Block(s)	
Code	Description
Blank	No contacts
Standard	
D1	1 N.O.
D2	1 N.C.
D3	1 N.O.E.M.
D4	1 N.C.L.B.
D5	1 N.O. (Mini)
D6	1 N.C. (Mini)
A1	1 N.C.L.B. - 1 N.O.
A2	2 N.O.‡
A4	2 N.C.
A7	1 N.C.L.B. - 1 N.C.
A	1 N.O. - 1 N.C.
B	2 N.O. - 2 N.C.

f (cont'd)

Contact Block(s)	
Code	Description
PenTUFF (Low Voltage)	
D1V	1 N.O.
D2V	1 N.C.
D3V	1 N.O.E.M.
D4V	1 N.C.L.B.
AV	1 N.O. - 1 N.C.
BV	2 N.O. - 2 N.C.
Time Delay	
T	1 N.O. Depress close, delayed opening
S	1 N.C. Depress open, delayed closure
Snap Action	
M	1 N.O. - 1 N.C.
N	2 N.O. - 2 N.C.
Class 1, Div. 2/Zone 2 Logic Reed	
D1R	1 N.O.
D2R	1 N.C.
A2R	2 N.O.‡
A4R	2 N.C.
AR	1 N.O. - 1 N.C.
BR	2 N.O. - 2 N.C.

f (cont'd)

Contact Block(s)	
Code	Description
Class 1, Div. 2/Zone 2 Sealed Switch	
D1P	1 N.O.
D2P	1 N.C.
AP	1 N.O. - 1 N.C.
BP	2 N.O. - 2 N.C.
Stackable Sealed Switch	
D1Y	1 N.O.
D2Y	1 N.C.
A2Y	2 N.O.
A4Y	2 N.C.
AY	1 N.O. - 1 N.C.
BY	2 N.O. - 2 N.C.
Time Delay Contacts	
Series C field installable kits can only be used with Series T or later operators. Adjustable range of 0.5 to 15 s + 25%. Maximum continuous current I _{th} 5 A.	
Snap Action Contacts	
Snap-action contacts feature a quick make, quick break snap-action mechanism that is only available on factory assembled units. Maximum continuous current I _{th} 10 A.	

- * Underlying operators are "flush head" type, except red which are "extended head". Boot material is chlorosulfonated polyethylene.
- * Not available for booted operators.
- ‡ A2 and A2R contact blocks cannot be stacked upon, but can stack on other contact blocks.
- § Jumbo mushroom heads not available in white color.



Bulletin 800T/H
30.5 mm Push Buttons
 Push Button Operators

Momentary Contact Push Button Devices, Illuminated



Extended Head Without Guard
Cat. No. 800T-PB16R



Extended Head with Guard
Cat. No. 800H-PRB16R

Type	Lamp Type	Volts	Color	Type 4/13		Type 4/4X13	
				Extended Head Without Guard*	Extended Head With Guard*	Extended Head without Guard*	Extended Head with Guard*
				Cat. No.	Cat. No.	Cat. No.	Cat. No.
Operator Only*				800T-SB00XX	800T-SA00XX	800H-SRB00XX	800H-SRA00XX
Full Voltage	Incandescent	24V AC/DC	Red	800T-QB24R	800T-QA24R	800H-QRB24R	800H-QRA24R
			Green	800T-QB24G	800T-QA24G	800H-QRB24G	800H-QRA24G
			Amber	800T-QB24A	800T-QA24A	800H-QRB24A	800H-QRA24A
	No Lamp	0...250V AC/DC	No Lens	800T-QBN25	800T-QAN25	800H-QRBN25	800H-QRAN25
Universal	LED	12...130V AC/DC	Red	800T-QBH2R	800T-QAH2R	800H-QRBH2R	800H-QRAH2R
			Green	800T-QBH2G	800T-QAH2G	800H-QRBH2G	800H-QRAH2G
			Amber	800T-QBH2A	800T-QAH2A	800H-QRBH2A	800H-QRAH2A
Transformer	Incandescent	120V AC, 50/60 Hz	Red	800T-PB16R	800T-PA16R	800H-PRB16R	800H-PRA16R
			Green	800T-PB16G	800T-PA16G	800H-PRB16G	800H-PRA16G
			Amber	800T-PB16A	800T-PA16A	800H-PRB16A	800H-PRA16A
	LED		Red	800T-PBH16R	800T-PAH16R	800H-PRBH16R	800H-PRAH16R
	Green		800T-PBH16G	800T-PAH16G	800H-PRBH16G	800H-PRAH16G	
	Amber		800T-PBH16A	800T-PAH16A	800H-PRBH16A	800H-PRAH16A	
	No Lamp		No Lens	800T-PBN16	800T-PAN16	800H-PRBN16	800H-PRAN16

* Includes as standard one Cat. No. 800T-XA (1 N.O. - 1 N.C.) contact block.

* Operator only supplied without power module, lamp, lens cap, or contact blocks.

800 T - P B H 16 R
 a b c d e f g h

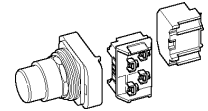

a

Protection Rating	
Code	Description
T	Metal, Type 4/13
H	Plastic, Type 4/4X13

b

Finger-Safe Guards	
Code	Description
Blank	No guards
C	Guards on terminals

c

Power Module Type		
800T Type 4/13	Description	800H Type 4/4X13
Code		Code
P	Transformer (or dual input)	PR
Q	Full voltage/ Universal	QR

d

Head Type	
Code	Description
A	Extended head with guard
B	Extended head without guard
M	Mushroom
MJ	Jumbo mushroom

e

Illumination Options	
Code	Description
Blank	Incandescent
H	LED
Dual Input	
D	Diode type ‡
T	Transformer — relay type
TH	Transformer — relay type LED

f

Voltage	
Transformer	
Code	Description
16	120V AC, 50/60 Hz
26	240V AC, 50/60 Hz
46	480V AC, 50/60 Hz
56	600V AC, 50/60 Hz
Full Voltage — Incandescent	
12	12V AC/DC
24	24V AC/DC
48	48V AC/DC
10	120V AC/DC
20	240V AC/DC
Universal — LED	
2	12...130V AC/DC
Dual Input	
16	120V AC
24	24V AC/DC ➤

g

Lens Color	
Code	Description
Blank	No lens with standard contacts 1 N.O. - 1 N.C.
X	No lens if ordering any contacts other than standard 1 N.O. - 1 N.C.
A	Amber
B	Blue
C	Clear
G	Green
R	Red
W	White

h

Contact Block(s)	
Code	Description
X	No contacts
Standard	
Blank	1 N.O. - 1 N.C.
D1	1 N.O.
PenTUFF (Low Voltage)	
AV	1 N.O. - 1 N.C.
Class 1, Div. 2/Zone 2	
Logic Reed	
AR	1 N.O. - 1 N.C.
Sealed Switch	
AP	1 N.O. - 1 N.C.
Stackable Sealed Switch	
AY	1 N.O. - 1 N.C.

‡ Diode type dual input provides circuit isolation via opposing diodes. Not recommended for use with solid-state outputs.
 ➤ Dual input diode only.

Momentary Contact Push Button Devices, Non-Illuminated — With Two-Color Molded Legend Caps

Operator Only

- Less legend cap
- Less contact blocks

Button Type	Type 4/13	Type 4/4X/13
	Cat. No.	Cat. No.
Flush	800T-A00	800H-AR00
Extended	800T-B00	800H-BR00



Cat. No. 800T-A00 with
 Cat. No. 800T-LC103W
 installed



Cat. No. 800H-BR00 with
 Cat. No. 800T-LC604
 installed

Legend Caps

Text	Cap Color	Text Color	Cat. No.
	Green	White	800T-LC101W
START			800T-LC103W
ON			800T-LC105W
START / I			800T-LC121W
O	Black	White	800T-LC202W
STOP			800T-LC204W
RESET			800T-LC207W
↑			800T-LC208W
FORWARD			800T-LC209W
REVERSE			800T-LC210W
JOG			800T-LC212W
UP			800T-LC213W
DOWN			800T-LC214W
RAISE			800T-LC215W
LOWER			800T-LC216W

Text	Cap Color	Text Color	Cat. No.
IN	Black	White	800T-LC217W
OUT			800T-LC218W
HIGH			800T-LC219W
LOW			800T-LC220W
STOP / O	White	Black	800T-LC222W
			800T-LC501B
START			800T-LC503B
↑			800T-LC508B
START / I	Red	White	800T-LC521B
O			800T-LC602W
STOP			800T-LC604W
OFF			800T-LC606W
STOP / O	Blue	White	800T-LC622W
RESET			800T-LC707W
R			800T-LC711W

Note: Package Qty. = 1

800 T - A 103W A

a b c d e

a

Protection Rating	
Code	Description
T	Metal, Type 4/13
H	Plastic, Type 4/4X/13

b

Finger-Safe Guards	
Code	Description
Blank	No guards
C	Guards on terminals

c

Operator Type		
800T Type 4/13	Description	800H Type 4/4X/13
Code		Code
A	Flush head	AR
B	Extended head	BR

d

Cap Text/Color			
Code	Text	Color	
		Cap	Text
101W		Green	White
103W	START		
105W	ON		
121W	START / I		
202W	O	Black	White
204W	STOP		
207W	RESET		
208W	↑		
209W	FORWARD		
210W	REVERSE		
212W	JOG		
213W	UP		
214W	DOWN		
215W	RAISE		
216W	LOWER		
217W	IN		
218W	OUT		
219W	HIGH		
220W	LOW		
222W	STOP / O	Red	White
501B			
503B	START		
508B	↑		
521B	START / I	Blue	White
602W	O		
604W	STOP		
606W	OFF		
622W	STOP / O	Blue	White
707W	RESET		
711W	R		

e

Contact Block(s)	
Code	Description
Blank	No contacts
Standard	
D1	1 N.O.
D2	1 N.C.
D3	1 N.O.E.M.
D4	1 N.C.L.B.
D5	1 N.O. (Mini)
D6	1 N.C. (Mini)
A1	1 N.C.L.B. - 1 N.O.
A2	2 N.O.‡
A4	2 N.C.
A7	1 N.C.L.B. - 1 N.C.
A	1 N.O. - 1 N.C.
B	2 N.O. - 2 N.C.
Class 1, Div. 2/Zone 2	
Sealed Switch	
D1P	1 N.O.
D2P	1 N.C.
AP	1 N.O. - 1 N.C.
BP	2 N.O. - 2 N.C.
Stackable Sealed Switch	
D1Y	1 N.O.
D2Y	1 N.C.
A2Y	2 N.O.
A4Y	2 N.C.
AY	1 N.O. - 1 N.C.
BY	2 N.O. - 2 N.C.

e (cont'd)

Contact Block(s)	
Code	Description
PenTUFF (Low Voltage)	
D1V	1 N.O.
D2V	1 N.C.
D3V	1 N.O.E.M.
D4V	1 N.C.L.B.
AV	1 N.O. - 1 N.C.
BV	2 N.O. - 2 N.C.
Time Delay	
T	1 N.O. Depress close, delayed opening
S	1 N.C. Depress open, delayed closure
Snap Action	
M	1 N.O. - 1 N.C.
N	2 N.O. - 2 N.C.
Class 1, Div. 2/Zone 2	
Logic Reed	
D1R	1 N.O.
D2R	1 N.C.
A2R	2 N.O.‡
A4R	2 N.C.
AR	1 N.O. - 1 N.C.
BR	2 N.O. - 2 N.C.

‡ A2 and A2R contact blocks cannot be stacked upon, but can stack upon other contact blocks.



Bulletin 800T/H
30.5 mm Push Buttons
 Selector Switches

2-Position Selector Switch Devices, Non-Illuminated



Standard Knob Operator
 Cat. No. 800T-H2A



Knob Lever Operator
 Cat. No. 800T-H17A



Standard Knob Operator
 Cat. No. 800H-HR2A

Contact Type	Side	Contact	Operator Position		M = Maintained S = Spring Return	Type 4/13		Type 4/4X/13
						Standard Knob	Knob Lever	Standard Knob
			Cat. No.	Cat. No.		Cat. No.		
No Contacts	—	—	—	—	M M	800T-H2	800T-H17	800H-HR2
					S→M	800T-H4	800T-H18	800H-HR4
					M←S	800T-H5	800T-H19	800H-HR5
1 N.O.	White	A	O	X	M M	800T-H2D1	800T-H17D1	800H-HR2D1
					S→M*	800T-H4D1	800T-H18D1	800H-HR4D1
					M←S	800T-H5D1	800T-H19D1	800H-HR5D1
1 N.O. - 1 N.C.	White	A B	O X	X O	M M	800T-H2A	800T-H17A	800H-HR2A
					S→M*	800T-H4A	800T-H18A	800H-HR4A
					M←S	800T-H5A	800T-H19A	800H-HR5A

Note: X = Closed/O = Open

* Target tables are reversed from those shown.

800 T - HA 2 A

a b c d e

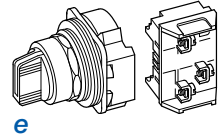

Protection Rating	
Code	Description
T	Metal, Type 4/13
H	Plastic, Type 4/4X/13

Finger-Safe Guards	
Code	Description
Blank	No guards
C	Guards on terminals

Knob Insert Colors		
800T Type 4/13	Description	800H Type 4/4X/13
Code		Code
H	White	HR
HX	Packet of colored inserts*	HRX
Metal Wing Lever Colors§		
Code	Color	Code
HA	Red	—
HG	Grey	—

Operator Type and Function	
Standard Knob	
Code	Operator Function
2	Maintained
4	Spring return from left‡
5	Spring return from right
Knob Lever§	
Code	Operator Function
17	Maintained
18	Spring return from left‡
19	Spring return from right
Metal Wing Lever§	
Code	Operator Function
11	Maintained
15	Spring return from left‡
16	Spring return from right
Coin Slot§	
Code	Operator Function
6	Maintained
7	Spring return from left
8	Spring return from right

Contact Block(s)			
Code	Contact Configuration	2-Position	
Blank	No contacts	—	—
Standard			
D1	1 N.O.	O	X
D2	1 N.C.	X	O
A	1 N.O. - 1 N.C.	O	X
		X	O
B	2 N.O. - 2 N.C.	O	X
		X	O
		O	X
		X	O
Max Duty (Horsepower Rated)*			
D1M	1 N.O.		
D2M	1 N.C.		
PenTUFF (Low Voltage)*			
D1V	1 N.O.		
D2V	1 N.C.		
AV	1 N.O. - 1 N.C.		
BV	2 N.O. - 2 N.C.		
Class1, Div. 2/Zone 2			
Logic Reed*			
D1R	1 N.O.		
D2R	1 N.C.		
AR	1 N.O. - 1 N.C.		
BR	2 N.O. - 2 N.C.		
Sealed Switch*			
D1P	1 N.O.		
D2P	1 N.C.		
AP	1 N.O. - 1 N.C.		
BP	2 N.O. - 2 N.C.		
Stackable Sealed Switch*			
D1Y	1 N.O.		
D2Y	1 N.C.		
AY	1 N.O. - 1 N.C.		
BY	2 N.O. - 2 N.C.		

10

* One insert of each color (blue, green, orange, red, and yellow).
 ‡ Target tables are reversed from those shown.
 § Only available on Bul. 800T, Type 4/13 operators.
 * Contact target tables same as those listed for standard contact blocks.

2-Position Selector Switch Devices, Non-Illuminated (Bul. 800T only)



2-Position Cylinder Lock Operator
 Cat. No. 800T-H33A

Contact Type	Side	Contact	Operator Position		M = Maintained S = Spring Return	Type 4/13 Cylinder Lock		
						Key Removal — Left*	Key Removal — Right*	Key Removal — Both*
						Cat. No.	Cat. No.	Cat. No.
No Contacts	—	—	—	—	M M	800T-H31	800T-H32	800T-H33
					M←S	800T-H48	—	—
1 N.O.	White	A	O	X	M M	800T-H31D1	800T-H32D1	800T-H33D1
					S→M*	—	800T-H42D1	—
					M←S	800T-H48D1	—	—
1 N.O. - 1 N.C.	White	A B	O X	X O	M M	800T-H31A	800T-H32A	800T-H33A
					S→M*	—	800T-H42A	—
					M←S	800T-H48A	—	—

Note: X = Closed/O = Open

800 T - H31 A

a *b* *c* *d* *e*

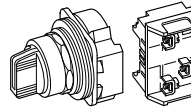

Protection Rating	
Code	Description
T	Metal, Type 4/13

Finger-Safe Guards	
Code	Description
Blank	No guards
C	Guards on terminals

Key Removal Position	
Maintained	
Code	Operator Function
H31	Key removal — left
H32	Key removal — right
H33	Key removal — both
Spring Return From Left	
Code	Operator Function
H42	Key removal — right*
Spring Return From Right	
Code	Operator Function
H48	Key removal — left

Key Options for Cylinder Locks*			
Code	T Series Key No.	Code	T Series Key No.
Blank	D018 (Std. Key)	15	T112
03	D020	16	T115
04	D025	17	T324
05	D335	18	T382
06	D429	19	T404
07	D461	20	T171
08	D111	21	T484
09	D587	22	T547
10	D682	23	T569
11	D713	24	T692
12	D900	25	T752
13	D992	26	T178
14	D118	—	—

Contact Block(s)			
Code	Description		
	Contact Configuration	2-Position	
Blank	No contacts	—	—
Standard			
D1	1 N.O.	O	X
D2	1 N.C.	X	O
A	1 N.O. - 1 N.C.	O	X
		X	O
B	2 N.O. - 2 N.C.	O	X
		X	O
		O	X
		X	O
Max Duty (Horsepower Rated)			
D1M	1 N.O.		
D2M	1 N.C.		
PenTUFF (Low Voltage)			
D1V	1 N.O.		
D2V	1 N.C.		
AV	1 N.O. - 1 N.C.		
BV	2 N.O. - 2 N.C.		
Class1, Div. 2/Zone 2			
Logic Reed§			
D1R	1 N.O.		
D2R	1 N.C.		
AR	1 N.O. - 1 N.C.		
BR	2 N.O. - 2 N.C.		
Sealed Switch§			
D1P	1 N.O.		
D2P	1 N.C.		
AP	1 N.O. - 1 N.C.		
BP	2 N.O. - 2 N.C.		
Stackable Sealed Switch§			
D1Y	1 N.O.		
D2Y	1 N.C.		
AY	1 N.O. - 1 N.C.		
BY	2 N.O. - 2 N.C.		

* Target tables are reversed from those shown.
 * Keys removable from maintained positions only.
 § Contact target tables same as those listed for standard and PenTUFF contact blocks.
 * Device supplied with 2 keys. Replacement key part no. for standard D018 key is X-181170. See page 10-46 for additional replacement key numbers.

3-Position Selector Switch Devices, Non-Illuminated (Bul. 800T only)



3-Position Cylinder Lock Operator
 Cat. No. 800T-J41A

Contact Type	Operator Position			M = Maintained S = Spring Return	Type 4/13 Cylinder Lock§		
					Key Removal — Left *	Key Removal — Center *	Key Removal — All *
					Cat. No.	Cat. No.	Cat. No.
No Contacts	—	—	—	M M M	800T-J41	800T-J42	800T-J44
				S→M M	—	800T-J50	—
				M M←S	800T-J69	800T-J38	—
				S→M←S	—	800T-J631	—
 1 N.O. - 1 N.C.	X O	O O	X O	M M M	800T-J41A	800T-J42A	800T-J44A
				S→M M	—	800T-J50A	—
				M M←S	800T-J69A	800T-J38A	—
				S→M←S	—	800T-J631A	—

Note: X = Closed/O = Open

800
 a b c d e f

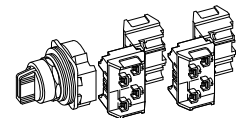

a

Protection Rating	
Code	Description
T	Metal, Type 4/13

b

Finger-Safe Guards	
Code	Description
Blank	No guards
C	Guards on terminals

c

Key Removal Position	
Maintained	
Code	Operator Function
J41	Key removal — left
J42	Key removal — center
J43	Key removal — right
J44	Key removal — all
J45	Key removal — left and center
J46	Key removal — right and left
J47	Key removal — right and center
Spring Return from Left	
J50	Key removal — center
J52	Key removal — right
J51	Key removal — right and center

c (cont'd)

Key Removal Position	
Spring Return from Right	
Code	Operator Function
J69	Key removal — left
J38	Key removal — center
J73	Key removal — left and center
Spring Return from Both	
J631	Key removal — center

d

Key Options for Cylinder Locks§	
Code	Key No.
Blank	D018 (standard key)
03	D020
04	D025
05	D335
06	D429

Note: Refer to page 10-13 for additional key option codes.

e

Cam Option*	
Code	Description
Blank	KB7 cam (std.)
KA1	KA1 cam
KA7	KA7 cam
KC1	KC1 cam

Note: See Table 1 on page 10-14 for cam selections.

e (cont'd)

Cam Option*	
Code	Description
KC7	KC7 cam
KD7	KD7 cam
KE7	KE7 cam
KQ1	KQ1 cam
KQ7	KQ7 cam
KR1	KR1 cam
KR7	KR7 cam
KT1	KT1 cam
KT7	KT7 cam
KU7	KU7 cam

f

Contact Blocks	
Code	Description
Blank	No contacts
Standard	
A	1 N.O. - 1 N.C. 1-800T-XA on white side 2 N.O. - 2 N.C. 2-800T-XAs — 1 on white side/1 on black side
B	2-800T-XAs — 1 on white side/1 on black side
PenTUFF (Low Voltage)	
AV	1 N.O. - 1 N.C. 1-800T-XAV on white side
BV	2 N.O. - 2 N.C. 2-800T-XAVs — 1 on white side/1 on black side

f (cont'd)

Contact Blocks	
Class 1, Div. 2/Zone 2	
Logic Reed	
Code	Description
AR	1 N.O. - 1 N.C. 1-800T-XAR on white side
BR	2 N.O. - 2 N.C. 2-800T-XARs — 1 on white side/1 on black side
Sealed Switch	
AP	1 N.O. - 1 N.C. 1-800T-XAP on white side
BP	2 N.O. - 2 N.C. 2-800T-XAPs — 1 on white side/1 on black side
Stackable Sealed Switch	
AY	1 N.O. - 1 N.C. 1-800T-XAY on white side
BY	2 N.O. - 2 N.C. 2-800T-XAYs — 1 on white side/1 on black side

* Key removable in maintained positions only.

‡ If an overlapping cam is required, consult your local Rockwell Automation sales office or Allen-Bradley distributor.

§ Device supplied with 2 keys. Replacement key part no. for standard D018 key is X-181170. See page 10-46 for additional replacement key numbers.

Bulletin 800T/H
30.5 mm Push Buttons
 Selector Switches

4-Position Selector Switch Devices, Non-Illuminated



Standard Knob Operator
 Cat. No. 800T-N2KN4B



Knob Lever Operator
 Cat. No. 800T-N17KN4B



Standard Knob Operator
 Cat. No. 800H-NR2KF4AAXX

Contact Type	Operator Position				M = Maintained S = Spring Return	Type 4/13		
						Standard Knob	Knob Lever	Type 4/4X/13
	Cat. No.			Cat. No.			Cat. No.	
No Contacts	—	—	—	—	M M M M	800T-N2KF4	800T-N17KF4	800H-NR2KF4
					S→M M M	800T-N3KF4	800T-N29KF4	800H-NR3KF4
					M M M←S	800T-N9KF4	800T-N30KF4	800H-NR9KF4
 2 N.O. - 2 N.C.	X	O	O	O	M M M M	800T-N2KF4B	800T-N17KF4B	800H-NR2KF4AAXX
	O	X	O	O	S→M M M	800T-N3KF4B	800T-N29KF4B	800H-NR3KF4AAXX
	O	O	X	X	M M M←S	800T-N9KF4B	800T-N30KF4B	800H-NR9KF4AAXX

Note: X = Closed/O = Open

800 T - N 2 KF4 B
 a b c d e f

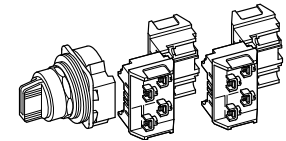

a

Protection Rating	
Code	Description
T	Metal, Type 4/13
H	Plastic, Type 4/4X/13

b

Finger-Safe Guards	
Code	Description
Blank	No guards
C	Guards on terminals

c

Knob Insert Colors		
800T Type 4/13	Description	800H Type 4/4X/13
Code		Code
N	White	NR
NX	Packet of colored inserts*	NRX
Metal Wing Lever Colors		
Code	Color	Code
NA	Red	—
NG	Grey	—

d

Operator Function and Knob Type	
Standard Knob	
Code	Operator Function
2	Maintained
3	Spring return from position 1 to position 2
9	Spring return from position 4 to position 3
Knob Lever§	
Code	Operator Function
17	Maintained
29	Spring return from position 1 to position 2
30	Spring return from position 4 to position 3
Metal Wing Lever§	
Code	Operator Function
11	Maintained
13	Spring return from position 1 to position 2
14	Spring return from position 4 to position 3

e

Cam Option*	
Code	Description
KF4	F cam
KG4	G cam
KK4	K cam
KM4	M cam
KP4	P cam
KN4	Overlapping cam*

f

Contact Blocks*		
800T Type 4/13	Description	800H Type 4/4X/13
Code		Code
Blank	No contacts	Blank
Standard		
B	2 N.O. - 2 N.C. 2- 800T-XA s — 1 on white side/ 1 on black side	AAXX
H	3 N.O. - 3 N.C. 3- 800T-XA s — 2 on white side/ 1 on black side	AAAX
C	4 N.O. - 4 N.C. 4- 800T-XA s — 2 on white side/ 2 on black side	AAAA

f (cont)

Contact Blocks		
800T Type 4/13	Description	800H Type 4/4X/13
Code		Code
PenTUFF (Low Voltage)		
BV	2 N.O. - 2 N.C.	FFXX
HV	3 N.O. - 3 N.C.	FFFX
CV	4 N.O. - 4 N.C.	FFFF
Class 1, Di. 2/Zone 2		
Logic Reed‡		
BR	2 N.O. - 2 N.C.	TTXX
HR	3 N.O. - 3 N.C.	TTTX
CR	4 N.O. - 4 N.C.	TTTT
Sealed Switch‡		
BP	2 N.O. - 2 N.C.	PPXX
Stackable Sealed Switch§		
BY*	2 N.O. - 2 N.C.	TTXX
HY*	3 N.O. - 3 N.C.	TTTX
CY*	4 N.O. - 4 N.C.	TTTT

- * One insert of each color (blue, green, orange, red, and yellow).
- † Overlapping cam. See Publication 800T-2.8 for overlap specifications.
- ‡ Contact block mounting same as listed for standard and PenTUFF contact blocks.
- § Only available on Bul. 800T, Type 4/13 operators.
- * See Table 1 for proper cam/contact selection.
- Not available with wing levers.

Table 1. Cam and Contact Block Functionality Table

Contact Block Suffix Code	Contact Block Side	Circuits	Cam Codes																						
			KF4		KG4		KK4		KM4		KP4		KN4*												
C	White	A	X	O	O	O	X	X	O	O	O	O	X	X	X	O	O	O	O	O	X	O	X	O	O
		B	O	X	O	O	O	O	X	X	O	O	X	X	O	O	X	X	O	O	X	O	O	O	O
H	Black	A	O	O	O	X	X	O	O	X	O	O	X	O	O	X	O	O	X	O	X	O	O	O	X
		B	O	O	X	O	O	O	O	X	O	X	X	O	O	X	O	O	X	O	O	X	O	O	O
C	White	A	X	O	O	O	X	X	O	O	O	O	X	X	X	O	O	O	O	O	X	O	X	O	O
		B	O	X	O	O	O	O	X	O	X	X	O	O	O	X	X	O	O	X	O	O	O	O	O
H	Black	A	O	O	O	X	X	O	O	O	X	O	O	X	O	O	X	O	O	X	O	X	O	O	X
		B	O	O	X	O	O	O	O	X	O	X	X	O	O	X	O	O	X	O	O	X	O	O	O

Note: X = Closed/O = Open

4-Position Selector Switch Devices, Non-Illuminated (800T only)



Cylinder Lock Operator
 Cat. No. 800T-N32KF4B

Contact Type	Operator Position				M = Maintained S = Spring Return	Cylinder Lock – Type 4/13§		
						Key Removal — Position 2*	Key Removal — Position 3*	Key Removal — All*
					Cat. No.	Cat. No.	Cat. No.	
No Contacts	—	—	—	—	M M M M	800T-N32KF4	800T-N33KF4	800T-N61KF4
					S→M M M	800T-N132KF4	800T-N133KF4	—
					M M M←S	800T-N232KF4	800T-N233KF4	—
	X O O O	O X O O	O O X O	O O O X	M M M M	800T-N32KF4B	800T-N33KF4B	800T-N61KF4B
					S→M M M	800T-N132KF4B	800T-N133KF4B	—
					M M M←S	800T-N232KF4B	800T-N233KF4B	—

Note: X = Closed/O = Open

800 T - N31 KM4 C
a b c d e f

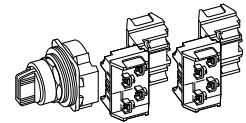

a

Protection Rating	
Code	Description
T	Metal, Type 4/13

b

Finger-Safe Guards	
Code	Description
Blank	No guards
C	Guards on terminals

c

Key Removal Position and Operator Function	
Maintained	
Code	Operator Function
N31	Key removal position 1
N32	Key removal position 2
N33	Key removal position 3
N34	Key removal position 4
N61	Key removal all positions

c (cont'd)

Key Removal Position and Operator Function	
Spring Return From Position 1 to Position 2	
Code	Description
N132	Key removal position 2
N133	Key removal position 3
N134	Key removal position 4
N154	Key removal positions 2, 3, and 4
Spring Return From Position 4 to Position 3	
Code	Operator Function
N231	Key removal position 1
N232	Key removal position 2
N233	Key removal position 3
N251	Key removal positions 1, 2, and 3

d

Key Options for Cylinder Locks§	
D Series	
Code	Key No.
Blank	D018 (standard key)
03	D020
04	D025
05	D335
06	D429

Note: Refer to page 10-13 for additional key option codes.

e

Cam Option	
Code	Description
KF4	F cam
KG4	G cam
KK4	K cam
KM4	M cam
KP4	P cam
KN4	Overlapping cam*

Note: See Table 1 for proper cam selection.

f

Contact Blocks	
Code	Description
Blank	No contacts
Standard	
B	2 N.O. - 2 N.C. 2- 800T-XAs — 1 on white side/1 on black side
H	3 N.O. - 3 N.C. 3- 800T-XAs — 2 on white side/1 on black side
C	4 N.O. - 4 N.C. 4- 800T-XAs — 2 on white side/2 on black side
PenTUFF (Low Voltage)	
BV	2 N.O. - 2 N.C. 2- 800T-XAVs — 1 on white side/1 on black side
HV	3 N.O. - 3 N.C. 3- 800T-XAVs — 2 on white side/1 on black side
CV	4 N.O. - 4 N.C. 4- 800T-XAVs — 2 on white side/2 on black side
Class 1, Div. 2/Zone 2	
Logic Reed†	
BR	2 N.O. - 2 N.C.
HR	3 N.O. - 3 N.C.
CR	4 N.O. - 4 N.C.
Sealed Switch‡	
BP	2 N.O. - 2 N.C.
Stackable Sealed Switch‡	
BY	2 N.O. - 2 N.C.
HY	3 N.O. - 3 N.C.
CY	4 N.O. - 4 N.C.

Note: Associated targets shown in Table 1.

Table 1. Cam and Contact Block Functionality Table

Contact Block Suffix Code	Contact Block Side	Circuits	Cam Codes																								
			KF4				KG4				KK4				KM4				KP4				KN4*				
C	White	A	X	O	O	O	X	X	O	O	O	O	X	X	X	O	O	O	O	O	O	X	O	X	O	O	
		B	O	X	O	O	O	O	X	O	X	X	O	O	O	X	X	O	O	X	O	O	O	O	O	O	X
	Black	A	O	O	O	X	X	O	O	O	X	O	O	X	O	O	X	O	O	X	X	O	O	X	O	O	O
		B	O	O	X	O	O	O	O	X	O	X	X	O	O	X	X	O	O	X	O	O	X	O	O	O	O
C	White	A	X	O	O	O	X	X	O	O	O	O	X	X	X	O	O	O	O	X	O	O	X	O	X	O	O
		B	O	X	O	O	O	O	X	O	X	X	O	O	O	X	X	O	O	X	O	O	O	O	O	O	X
	Black	A	O	O	O	X	X	O	O	O	X	O	O	X	O	O	X	O	O	X	X	O	X	O	X	O	O
		B	O	O	X	O	O	O	O	X	O	X	X	O	O	X	X	O	O	X	O	O	X	O	O	O	O

Note: X = Closed/O = Open

* Key removable in maintained positions only.

† Overlapping cam. One layer of contact blocks allowed, no stacking. See Publication 800T-2.8 for overlap specifications.

‡ Contact block mounting same as listed for standard and PenTUFF contact blocks.

§ Device supplied with 2 keys. Replacement key part no. for standard D018 key is X-181170. See page 10-46 for additional replacement key numbers.

Bulletin 800T/H
30.5 mm Push Buttons
 Selector Switches

2-Position Knob/Lever Type Selector Switch Devices, Illuminated



Standard Knob Operator
 Cat. No. 800T-16HR2KB6AX



Knob Lever Operator
 Cat. No. 800H-16HRR17KB6AX

Type	Lamp Type	Volts	Knob Color	Operator Position		M = Maintained S = Spring Return	Type 4/13	Type 4/4X/13
							Standard Knob	Standard Knob
Operator Only*				No Contacts			Cat. No.	Cat. No.
Full Voltage	Incandescent	24V AC/DC	Red	X	O	M M	800T-00HX2KB6	800H-00HRX2KB6
						M M	800T-24HR2KB6AX	800H-24HRR2KB6AX
	S→M*	800T-24HR4KL8AX	800H-24HRR4KL8AX					
	M←S	800T-24HR5KL8AX	800H-24HRR5KL8AX					
Universal	No Lamp	0...250V AC/DC	No Knob	O	X	M M	800T-25HXN2KB6AX	800H-25HRXN2KB6AX
						M M	800T-2HRH2KB6AX	800H-2HRRH2KB6AX
	S→M*	800T-2HRH4KL8AX	800H-2HRRH4KL8AX					
	M←S	800T-2HRH5KL8AX	800H-2HRRH5KL8AX					
Transformer	Incandescent	120V AC 50/60 Hz	Red	X	O	M M	800T-16HR2KB6AX	800H-16HRR2KB6AX
						S→M*	800T-16HR4KL8AX	800H-16HRR4KL8AX
						M←S	800T-16HR5KL8AX	800H-16HRR5KL8AX
						M M	800T-16HRH2KB6AX	800H-16HRRH2KB6AX
	S→M*	800T-16HRH4KL8AX	800H-16HRRH4KL8AX					
	M←S	800T-16HRH5KL8AX	800H-16HRRH5KL8AX					
	No Lamp	120V AC 50/60 Hz	No Knob			M M	800T-16HXN2KB6AX	800H-16HRXN2KB6AX

Note: X = Closed/O = Open

* Operator only supplied without power module, lamp, lens cap, or contact blocks.

* Target tables are reversed from those shown.

800 T - 16 H R 2 KB6 A X

a b c d e f g h i j

1st Level 2nd Level

Protection Rating	
Code	Description
T	Metal, Type 4/13
H	Plastic, Type 4/4X/13

Finger-Safe Guards	
Code	Description
Blank	No guards
C	Guards on terminals

Power Module Type and Voltage	
Full Voltage — Incandescent	
Code	Description
12	12V AC/DC
24	24V AC/DC
48	48V AC/DC
Universal — LED	
2	12...130V AC/DC
Transformer	
16	120V AC 50/60 Hz
26	240V AC 50/60 Hz

For other voltages, please contact your local Rockwell Automation sales office or Allen-Bradley distributor.

No. of Positions		
Bul. 800T Type 4/13	Description	Bul. 800H Type 4/4X/13
Code		Code
H	2-position	HR

Knob Color	
Code	Color
A	Amber
B	Blue
C	Clear
G	Green
R	Red
W	White
X	No knob

Illumination Options	
Code	Description
Blank	Incandescent
H	LED

Table 1. Selector Switch Cam Targets

Cam Description (2-Position)		
Target		Contact Block Code*
		D, H, V, R, 5
		E, U, W, S, 6

X = Closed/O = Open

Operator Function and Knob Type	
Standard Knob or No Knob	
Code	Operator Function
2	Maintained
4	Spring return from left
5	Spring return from right
Knob Lever	
17	Maintained
18	Spring return from left
19	Spring return from right

Cam Options	
2-Position	
Code	Operator Function
KB6	Maintained Cam
KL8	Spring Return Cam

Table 2. Contact Block Code Reduction Rules

Contact Block Substitution	
Combination	Code
Standard	
D + E	A
D + D	M
E + E	N

Contact Blocks*	
Code	Description
Blank (both pos.)	No contacts
Standard	
D	1 N.O.
E	1 N.C.
A	1 N.O. - 1 N.C.
X	No contacts in this position
PenTUFF (Low Voltage)	
H	1 N.O.
U	1 N.C.
F	1 N.O. - 1 N.C.
Class 1, Div. 2/Zone 2	
Logic Reed	
V	1 N.O.
W	1 N.C.
T	1 N.O. - 1 N.C.
Sealed Switch	
R	1 N.O.
S	1 N.C.
P	1 N.O. - 1 N.C.
Stackable Sealed Switch	
5	1 N.O.
6	1 N.C.
7	1 N.O. - 1 N.C.

* Contact blocks used on white side only.

* Target tables are reversed for spring return from left operators.

3-Position Knob/Lever Type Selector Switch Devices, Illuminated



Standard Knob Operator
 Cat. No. 800T-16JR2KB7AX



Standard Knob Operator
 Cat. No. 800H-16JRR2KB7AX

Type	Lamp Type	Volts	Color	Operator Position			M = Maintained S = Spring Return	Type 4/13	Type 4/4X/13			
								Standard Knob	Standard Lever			
Operator Only*				No Contacts			Cat. No.	Cat. No.				
Full Voltage	Incandescent	24V AC/DC	Red	X O	O O	O X	M M M	800T-00JX2KB7	—			
							M M M	800T-24JR2KB7AX	800H-24JRR2KB7AX			
	S→M M	800T-24JR4KB7AX	800H-24JRR4KB7AX									
	M M←S	800T-24JR5KB7AX	800H-24JRR5KB7AX									
Universal	LED	12...130V AC/DC	Red	X O	O O	O X	M M M	800T-25JXN2KB7AX	—			
							M M M	800T-2JRH2KB7AX	800H-2JRRH2KB7AX			
							S→M M	800T-2JRH4KB7AX	800H-2JRRH4KB7AX			
							M M←S	800T-2JRH5KB7AX	800H-2JRRH5KB7AX			
Transformer	Incandescent	120V AC 50/60 Hz	Red	X O	O O	O X	M M M	800T-16JR2KB7AX	800H-16JRR2KB7AX			
							S→M M	800T-16JR4KB7AX	800H-16JRR4KB7AX			
							M M←S	800T-16JR5KB7AX	800H-16JRR5KB7AX			
							M M M	800T-16JRH2KB7AX	800H-16JRRH2KB7AX			
	LED	120V AC 50/60 Hz	Red				X O	O O	O X	S→M M	800T-16JRH4KB7AX	800H-16JRRH4KB7AX
										M M←S	800T-16JRH5KB7AX	800H-16JRRH5KB7AX
										M M M	800T-16JXN2KB7AX	—
										M M M	800T-16JXN2KB7AX	—

Note: X = Closed/O = Open

* Operator only supplied without power module, lamp, lens cap, or contact blocks.

800 T - 16 J R 2 KB7 A X

a b c d e f g h i j

a

Protection Rating	
Code	Description
T	Metal, Type 4/13
H	Plastic, Type 4/4X/13

b

Finger-Safe Guards	
Code	Description
Blank	No guards
C	Guards on terminals

c

Power Module Type and Voltage	
Full Voltage — Incandescent	
Code	Description
12	12V AC/DC
24	24V AC/DC
48	48V AC/DC
Universal — LED	
2	12...130V AC/DC
Transformer	
16	120V AC 50/60 Hz
26	240V AC 50/60 Hz

For other voltages, please contact your local Rockwell Automation sales office or Allen-Bradley distributor.

d

No. of Positions		
800T Type 4/13	Description	800H Type 4/4X/13
Code		Code
J	3-position	JR

e

Knob Color	
Code	Color
A	Amber
B	Blue
C	Clear
G	Green
R	Red
W	White
X	No knob

f

Illumination Options	
Code	Description
Blank	Incandescent
H	LED†

g

Operator Function and Knob Type	
Standard Knob or No Knob	
Code	Operator Function
2	Maintained
4	Spring return from left
5	Spring return from right
91	Spring return from both
Knob Lever	
Code	Operator Function
17	Maintained
18	Spring return from left
19	Spring return from right
20	Spring return from both

‡ LED only.

† LEDs available in red, green, amber, blue, and white. White LEDs only available in 6V, 24V, 120V, and 130V full voltage and all transformer units. LED color matches lens color, except clear lens supplied with white LED and white lens supplied with amber LED. All LEDs except 120V have an internal shunt resistor for use with solid-state outputs.

§ Contact blocks used on white side only.

h

Cam Options	
3-Position	
Code	Operator Function
KB7	B7 cam
KC1	C1 cam
KC7	C7 cam
KE7	E7 cam
KQ1	Q1 cam
KT1	T1 cam

i, j

Contact Blocks§	
Code	Description
Blank (both pos.)	No contacts

i, j (cont'd)

Contact Blocks§	
Code	Description
Standard	
A	1 N.O. - 1 N.C.
X	No contacts in this position
PenTUFF (Low Voltage)	
F	1 N.O. - 1 N.C.
Class 1, Div. 2/Zone 2	
Logic Reed	
T	1 N.O. - 1 N.C.
Sealed Switch	
P	1 N.O. - 1 N.C.
Stackable Sealed Switch	
7	1 N.O. - 1 N.C.

Table 1. Selector Switch Cam Targets

Target			Cam Description (3-Position)					
			KB7	KC1	KC7	KE7	KQ1	KT1
X	O	O	D, H, V, R, 5	—	D, H, V, R, 5	D, H, V	—	E, U, W, S, 6
O	X	O	—	E, U, W, S, 6	E, U, W, S, 6	—	E, U, W, S, 6	—
O	O	X	E, U, W, S, 6	D, H, V, R, 5	—	—	—	D, H, V, R, 5
X	X	O	G, I	J, Q	—	—	—	J, Q
O	X	X	J, Q	—	J, Q	E, U, W, S, 6	—	—
X	O	X	—	G, I	G, I	—	D, H, V, R, 5	—

Bulletin 800T/H

30.5 mm Push Buttons

Pilot Lights

Pilot Light Devices*



Transformer Type Pilot Light
Cat. No. 800T-P16R



Push-to-Test Pilot Light
Cat. No. 800T-PT16R

Type	Lamp Type	Volts	Color	Type 4/13		Type 4/4X/13	
				Pilot Light	Push-to-Test*	Pilot Light	Push-to-Test*
				Cat. No.	Cat. No.	Cat. No.	Cat. No.
Operator Only*				800T-S00	800T-SB00XX	800H-SR00	800H-SRB00XX
Full Voltage†	Incandescent	24V AC/DC	Red	800T-Q24R	800T-QT24R	800H-QR24R	800H-QRT24R
			Green	800T-Q24G	800T-QT24G	800H-QR24G	800H-QRT24G
			Amber	800T-Q24A	800T-QT24A	800H-QR24A	800H-QRT24A
	No Lamp	0...250V AC/DC	No Lens	800T-QN25	800T-QTN25	—	—
Universal†	LED	12...130 V AC/DC	Red	800T-QH2R	800T-QTH2R	800H-QRH2R	800H-QRTH2R
			Green	800T-QH2G	800T-QTH2G	800H-QRH2G	800H-QRTH2G
			Amber	800T-QH2A	800T-QTH2A	800H-QRH2A	800H-QRTH2A
Transformer†	Incandescent	120V AC, 50/60 Hz	Red	800T-P16R	800T-PT16R	800H-PR16R	800H-PRT16R
			Green	800T-P16G	800T-PT16G	800H-PR16G	800H-PRT16G
			Amber	800T-P16A	800T-PT16A	800H-PR16A	800H-PRT16A
	LED		Red	800T-PH16R	800T-PTH16R	800H-PRH16R	800H-PRTH16R
			Green	800T-PH16G	800T-PTH16G	800H-PRH16G	800H-PRTH16G
			Amber	800T-PH16A	800T-PTH16A	800H-PRH16A	800H-PRTH16A
	No Lamp		No Lens	800T-PN16	800T-PTN16	—	—

* Includes one standard Cat. No. 800T-XA (1 N.O. - 1 N.C.) contact block. For typical pilot light wiring diagrams, see page 10-65.

* Operator only supplied without power module, lamp, lens cap, or contact blocks.

† All pilot lights except push-to-test without sealed contacts and dual input transformer relay, are rated for Class 1, Division 2 applications.

800 T - P T 16 G AR (Push-to-Test)

a b c d e f g h

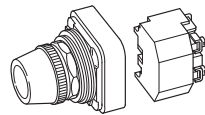

Protection Rating	
Code	Description
T	Metal, Type 4/13
H	Plastic, Type 4/4X/13

Finger-Safe Guards	
Code	Description
Blank	No guards
C	Guards on terminals

Power Module Type		
800T Type 4/13	Description	800H Type 4/4X/13
Code		Code
P	Transformer (or dual input)	PR
Q	Full voltage/ Universal	QR

Lamp Test Options	
Code	Description
Blank	No test option
T	Push-to-test
D	Dual input — diode*
DT	Dual input — transformer relay

Note: Push-to-test supplied with factory jumpered contact block.

Illumination Options	
Code	Description
Blank	Incandescent
H	LED*

Voltage	
Transformer	
Code	Description
16	120V AC 50/60 Hz
26	240V AC 50/60 Hz
46	480V AC 50/60 Hz
56	600V AC 50/60 Hz
Full Voltage — Incandescent	
12	12V AC/DC
24	24V AC/DC
48	48V AC/DC
10	120V AC/DC
20	240V AC/DC
Universal — LED	
2	12...130V AC/DC
Dual Input	
16	120V AC
24	24V AC/DC (Dual input diode only)

Lens Color		
Code	Color	Glass Code
Blank	No lens	Blank
A	Amber	D
B	Blue	E
C	Clear	F
G	Green	H
R	Red	J
W	White	K

Contact Blocks (Push-to-test units only)	
Code	Description
Standard	
Blank	1 N.O. - 1 N.C.
PenTUFF (Low Voltage)	
AV	1 N.O. - 1 N.C.
Class 1, Div. 2/Zone 2	
Logic Reed	
AR	1 N.O. - 1 N.C.
Sealed Switch	
AP	1 N.O. - 1 N.C.
Stackable Sealed Switch	
AY	1 N.O. - 1 N.C.

- * LED illumination option is not available with diode type dual input.
- * Diode type dual input provides circuit isolation via opposing diodes. Not recommended for use with solid-state outputs.
- * Glass lens available on 800T pilot lights only. Not available on push-to-test units.

2-Position Red Push-Pull and Push-Pull/Twist Release Devices, Non-Illuminated

Note: A jumbo or large legend plate is recommended, if space allows.



2-Position Push-Pull
 Cat. No. 800T-FX6D4



2-Position Metal Push-Pull
 Cat. No. 800T-FXLE6D4S



2-Position Push-Pull / Twist
 Cat. No. 800T-FXT6D4



2-Position Push-Pull / Twist
 Cat. No. 800H-FRXT6D4

Contact Type	Operator Position		Type 4/13			Type 4/4X/13
			Push-Pull — 40 mm	Push-Pull — 63 mm Metal	Push-Pull/Twist Release	Push-Pull/Twist Release
	Out	In	Cat. No.	Cat. No.	Cat. No.	Cat. No.
N.C.L.B.*	X	O	800T-FX6D4	800T-FXLE6D4	800T-FXT6D4	800H-FRXT6D4
N.O. - N.C.L.B.*	O	X	800T-FX6A1	800T-FXLE6A1	800T-FXT6A1	800H-FRXT6A1
N.C.L.B. - N.C.L.B.*	X	O	800T-FX6A5	800T-FXLE6A5	800T-FXT6A5	800H-FRXT6A5
S.M.C.B.*†	X	O	800TC-FX6D4S	800TC-FXLE6D4S	800TC-FXT6D4S	800HC-FRXT6D4S
N.O. - S.M.C.B.*†	O	X	800TC-FX6A1S	800TC-FXLE6A1S	800TC-FXT6A1S	800HC-FRXT6A1S
S.M.C.B. - S.M.C.B.*†	X	O	800TC-FX6A5S	800TC-FXLE6A5S	800TC-FXT6A5S	800HC-FRXT6A5S

Note: X = Closed/O = Open

Note: These caps are only available in plastic.

Note: Emergency stop push buttons are compliant with EN ISO 13850 and EN/IEC 60947-5-5 Standards when using N.C.L.B. contact blocks.

* The Self Monitoring Contact Block (S.M.C.B.) is composed of a N.C.L.B. contact wired in series with a N.O. monitoring contact. The N.O. monitoring contact automatically closes when the S.M.C.B. is properly installed onto the E-stop operator. If the S.M.C.B. is separated from the E-stop operator, the N.O. monitoring contact will automatically open.

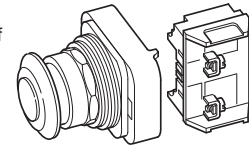

800 T - FX 1 A1

a b c d e

a

Protection Rating	
Code	Description
T	Metal, Type 4/13
H	Plastic, Type 4/4X/13

b

Finger-Safe Guards	
Code	Description
Blank	No guards
C	Guards on terminals

c

Head Type†		
800T Type 4/13	Description	800H Type 4/4X/13
Code		Code
FX	Mushroom head (push-pull)	—
FXC	90 mm anodized aluminum head (push-pull)	—
FXJ	Jumbo mushroom head (push-pull)	—
FXJE	Jumbo mushroom head (push-pull) with "E-Stop"	—
FXL	63 mm anodized aluminum head (push-pull)	—
FXLE	63 mm anodized aluminum head (push-pull) with "E-Stop"	—
FXT	Push-pull/twist-to-release	FRXT
FXJT	Jumbo head push-pull with twist-to-release	FRXJT

d

Color Cap	
Code	Color
Blank	No cap§
1	Green
2	Black
3	Orange
4	Grey
5	White
6	Red
7	Blue
9	Yellow

e

Contact Block(s)				
Code	Operator Position		Description	
Blank	—	—	No contacts on operator	
Standard				
D1	O	X	1 N.O.	
D2	X	O	1 N.C.	
D4	X	O	1 N.C.L.B.	
A	O	X	1 N.O. - 1 N.C.	
A1	O	X	1 N.O. - 1 N.C.L.B.	
A5	X	O	2 N.C.L.B.	

e (cont'd)

Contact Block(s)			
Code	Operator Position		Description
Blank	—	—	No contacts
PenTUFF (Low Voltage)			
D1V	O	X	1 N.O.
D2V	X	O	1 N.C.
D4V	X	O	1 N.C.L.B.
AV	O	X	1 N.O. - 1 N.C.
X	X	O	
Class 1, Div. 2/Zone 2			
Logic Reed			
D1R	O	X	1 N.O.
D2R	X	O	1 N.C.
AR	O	X	1 N.O. - 1 N.C.
X	X	O	
Sealed Switch			
D1P	O	X	1 N.O.
D2P	X	O	1 N.C.
AP	O	X	1 N.O.
X	X	O	1 N.C.
Stackable Sealed Switch			
D1Y	O	X	1 N.O.
D2Y	X	O	1 N.C.
AY	O	X	1 N.O. - 1 N.C.
X	X	O	

Note: X = Closed/O = Open

* Normally closed late break contact. When button is pushed from the OUT to IN position, the mechanical detent action of the operator occurs before electrical contacts change state. When the button is pulled from the IN in the OUT position, the electrical contacts change state before the mechanical detent occurs.

† Devices with N.C.L.B. contacts meet EN ISO 13850 and IEC 60947-5-5 standards for emergency stop applications.

§ Not valid with head Type J or JT.

Bulletin 800T/H
30.5 mm Push Buttons
 Push-Pull Operators

3-Position Push-Pull Devices, Non-Illuminated

Note: A jumbo or large legend plate is recommended, if space allows.



3-Position Push-Pull
 Cat. No. 800T-FXM6A7



3-Position Push-Pull
 Cat. No. 800H-FRXM6A7

Contact Type	Operator Position			Operator Position		
	Momentary	Maintained	Maintained	Momentary	Maintained	Momentary
	Out	Center	In	Out	Center	In
N.C.-	X	O	O	X	O	O
N.C.L.B.*	X	X	O	X	X	O

Button Color	Type 4/13	Type 4/4X/13	Type 4/13	Type 4/4X/13
	Push-Pull*	Push-Pull*	Push-Pull*	Push-Pull*
	Cat. No.	Cat. No.	Cat. No.	Cat. No.
Red	800T-FXM6A7	800H-FRXM6A7	800T-FXN6A7	800H-FRXN6A7

Note: X = Closed/O = Open

* Normally closed late break contact. When button is pushed from the OUT to IN position, the mechanical detent action of the operator occurs before electrical contacts change state. When the button is pulled from the IN to the OUT position, the electrical contacts change state before the mechanical detent occurs.

* Devices with N.C.L.B. contacts meet EN ISO 13850 and IEC 60947-5-5 standards for emergency stop applications.

800 T - FX M 1 A7
 a b c d e f

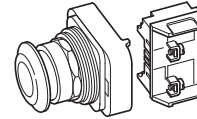

a

Protection Rating	
Code	Description
T	Metal, Type 4/13
H	Plastic, Type 4/4X/13

b

Finger-Safe Guards	
Code	Description
Blank	No guards
C	Guards on terminals

c

Head Type*		
800T Type 4/13	Description	800H Type 4/4X/13
Code		Code
FX	Mushroom head (push-pull)	FRX
FXC	90 mm anodized aluminum head (push-pull)	—
FXJ	Jumbo mushroom head (push-pull)	FRXJ
FXL	63 mm anodized aluminum head (push-pull)	—

d

Operator Function			
Code	Operator Position		
	Out	Center	In
M	Momentary	Maintained	Maintained
N	Momentary	Maintained	Momentary

e

Color Cap	
Code	Color
Blank	No cap†
1	Green
2	Black
3	Orange
4	Grey
5	White
6	Red
7	Blue
9	Yellow

f

Contact Block(s)				
Code	Operator Position			Description
	Out	Ctr.	In	
Blank	—	—	—	No contacts
Standard				
A	O	O	X	1 N.O. - 1 N.C.
	X	O	O	
A1	O	O	X	1 N.O. - 1 N.C.L.B.
	X	X	O	
A7	X	O	O	1 N.C. - 1 N.C.L.B.
	X	X	O	
B6	X	O	O	2 N.C. - 2 N.C.L.B.
	X	X	O	
	X	O	O	
	X	X	O	
PenTUFF (Low Voltage)				
AV	O	O	X	1 N.O. - 1 N.C.
	X	O	O	

f (cont'd)

Contact Block(s)				
Code	Operator Position			Description
	Out	Ctr.	In	
Class 1, Div. 2/Zone 2				
Logic Reed				
AR	O	O	X	1 N.O. - 1 N.C.
	X	O	O	
Sealed Switch				
AP	O	O	X	1 N.O. - 1 N.C.
	X	O	O	
Stackable Sealed Switch				
AY	O	O	X	1 N.O. - 1 N.C.
	X	O	O	

Note: X = Closed/O = Open

* Devices with N.C.L.B. contacts meet EN ISO 13850 and IEC 60947-5-5 standards for emergency stop applications.

† Not valid with head Type J.

2-Position Red Push-Pull and Push-Pull/Twist Release Devices, Illuminated

Note: A jumbo or large legend plate is recommended, if space allows.



Illuminated 2-Position Push-Pull
 Cat. No. 800T-FXP16RA1



2-Position Push-Pull
 Cat. No. 800T-FXJEP16RA1



Illuminated 2-Position Push-Pull/Twist
 Cat. No. 800T-FXTP16RA1



Illuminated 2-Position Push-Pull/Twist
 Cat. No. 800H-FRXT16RA1

Type	Lamp Type	Volts	Color	Contacts	Operator Position		Type 4/13			Type 4/4X/13
					Out	In	Push-Pull — 40 mm❖	Push-Pull — 60 mm with "E-Stop"❖	Push-Pull/Twist Release❖	Push-Pull/Twist Release❖
Operator Only*					No Contacts		800T-FXS00X	—	800T-FXTS00X	800H-FRXTS00X
Full Voltage	Incan.	24V AC/DC	Red	N.O. - N.C.L.B. ❖	O	X	800T-FXQ24RA1	800T-FXJEQ24RA1	800T-FXTQ24RA1	800H-FRXTQ24RA1
	No Lamp	0...250V AC/DC	No Lens				800T-FXQN25XA1	—	800T-FXTQN25XA1	800H-FRXTQN25XA1
Universal	LED	12...130V AC/DC	Red	N.O. - N.C.L.B. ❖	O	X	800T-FXQH2RA1	800T-FXJEQH2RA1	800T-FXTQH2RA1	800H-FRXTQH2RA1
Transformer	Incan.	120V AC	Red				N.O. - N.C.L.B. ❖	O	X	800T-FXP16RA1
		240V AC		800T-FXP26RA1	800T-FXJEP26RA1	800T-FXTP26RA1				800H-FRXT26RA1
	LED	120V AC		800T-FXPH16RA1	800T-FXJEPH16RA1	800T-FXTPH16RA1				800H-FRXTPH16RA1
		240V AC		800T-FXP26RA1	800T-FXJEPH26RA1	800T-FXTPH26RA1				800H-FRXTPH26RA1
Transformer	No Lamp	120V AC	No Lens			800T-FXPN16XA1	—	800T-FXTPN16XA1	800H-FRXTPN16XA1	

Note: X = Closed/O = Open Note: Emergency stop push buttons are compliant with EN ISO 13850 and EN/IEC 60947-5-5 Standards when using N.C.L.B. contact blocks.

* Operator only supplied without power module, lamp, lens cap, or contact blocks.

❖ Normally closed late break contact. When button is pushed from the OUT to IN position, the mechanical detent action of the operator occurs before electrical contacts change state. When the button is pulled from the IN to the OUT position, the electrical contacts change state before the mechanical detent occurs.

❖ Consult your local Rockwell Automation sales office or Allen-Bradley distributor for availability of illuminated E-stops with Self Monitoring Contact Blocks (SMCBs).

800 T - FX T PH 16 R A1

a b c d e f g h

Protection Rating	
Code	Description
T	Metal, Type 4/13
H	Plastic, Type 4/4X/13

Finger-Safe Guards	
Code	Description
Blank	No guards
C	Guards on terminals

Head Type§		
800T Type 4/13	Description	800H Type 4/4X/13
Code		Code
FX	Mushroom head	FRX
FXJ	Jumbo mushroom	FRXJ
FXJE	Jumbo mushroom (push-pull) with "E-Stop"	—

Operator Function	
Code	Description
Blank	Push-pull▲
T	Push-pull/twist

Illumination Options	
Transformer	
Code	Description
P	Incandescent
PH	LED
Full Voltage	
Q	Incandescent
QH	Universal LED
Dual Input	
D	Diode type
DT	Transformer — relay type
DTH	Transformer — relay type LED

Voltage‡	
Transformer	
Code	Description
16	120V AC 50/60 Hz
26	240V AC 50/60 Hz
Full Voltage	
24	24V AC/DC
10	120V AC/DC
20	240V AC/DC
Universal LED	
2	12...130V AC/DC
Dual Input	
16	120V AC
24	24V AC/DC (dual input diode only)

Color Cap	
Code	Color
X	No cap (not valid with head Type J)
A	Amber
B	Blue
C	Clear
G	Green
R	Red
W	White

Target		
Contact		
N.O.	O	X
N.C./N.C.L.B.	X	O

Contact Blocks	
Code	Description
Blank	No contacts
Standard	
D1	1 N.O.
D2	1 N.C.
D4	1 N.C.L.B.
A	1 N.O. - 1 N.C.
A1	1 N.O. - 1 N.C.L.B.
A5	2 N.C.L.B.
PenTUFF (Low Voltage)	
D1V	1 N.O.
D2V	1 N.C.
D4V	1 N.C.L.B.
AV	1 N.O. - 1 N.C.

h (cont'd)

Contact Blocks	
Code	Description
Class 1, Div. 2/Zone 2	
Logic Reed	
D1R	1 N.O.
D2R	1 N.C.
AR	1 N.O. - 1 N.C.
Sealed Switch	
D1P	1 N.O.
D2P	1 N.C.
AP	1 N.O. - 1 N.C.
Stackable Sealed Switch	
D1Y	1 N.O.
D2Y	1 N.C.
AY	1 N.O. - 1 N.C.

‡ See page 10-20 for additional voltage code options.

§ Devices with N.C.L.B. contacts meet EN ISO 13850 and IEC 60947-5-5 standards for emergency stop applications.

▲ Push-Pull is available only with Bul. 800T.

⚡ Diode type dual input provides circuit isolation via opposing diodes. Not recommended for use with solid-state outputs.

Bulletin 800T/H
30.5 mm Push Buttons
 Push-Pull Operators

3-Position Push-Pull Devices, Illuminated



Illuminated 3-Position Push-Pull
 Cat. No. 800T-FXMP16RA7



Illuminated 3-Position Push-Pull
 Cat. No. 800H-FRXMP16A7

				Operator Position			Operator Position		
				Momentary	Maintained	Maintained	Momentary	Maintained	Momentary
Contacts				Out	Center	In	Out	Center	In
N.C.-				X	O	O	X	O	O
N.C.L.B.*				X	X	O	X	X	O

Type	Lamp Type	Volts	Color	Type 4/13	Type 4/4X/13	Type 4/13	Type 4/4X/13
				Cat. No.‡	Cat. No.‡	Cat. No.‡	Cat. No.‡
Operator Only*				800T-FXMS00X	800H-FRXMS00X	800T-FXNS00X	800H-FRXNS00X
Full Voltage	Incandescent	24V AC/DC	Red	800T-FXMQ24RA7	800H-FRXMQ24RA7	800T-FXNQ24RA7	800H-FRXNQ24RA7
	No Lamp	0...250V AC/DC	No Lens	800T-FXMQN25XA7	800H-FRXMQN25XA7	800T-FXNQN25XA7	800H-FRXNQN25XA7
Universal	LED	12...130V AC/DC	Red	800T-FXMQH2RA7	800H-FRXMQH2RA7	800T-FXNQH2RA7	800H-FRXNQH2RA7
Transformer	Incandescent	120V AC	Red	800T-FXMP16RA7	800H-FRXMP16RA7	800T-FXNP16RA7	800H-FRXNP16RA7
	LED	120V AC		800T-FXMPH16RA7	800H-FRXMPH16RA7	800T-FXNPH16RA7	800H-FRXNPH16RA7
	No Lamp	120V AC	No Lens	800T-FXMPN16XA7	800H-FRXMPN16XA7	800T-FXNPN16XA7	800H-FRXNPN16XA7

Note: X = Closed/O = Open

* Normally closed late break contact. When button is pushed from the OUT to IN position, the mechanical detent action of the operator occurs before electrical contacts change state. When the button is pulled from the IN to the OUT position, the electrical contacts change state before the mechanical detent occurs.

* Operator only supplied without power module, lamp, lens cap, or contact blocks.

‡ Devices with N.C.L.B. contacts meet EN ISO 13850 and EN/IEC 60947-5-5 standards for emergency stop applications.

800 T - FX M PH 16 R A1

a b c d e f g h

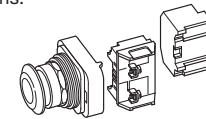

a

Protection Rating	
Code	Description
T	Metal, Type 4/13
H	Plastic, Type 4/4X/13

b

Finger-Safe Guards	
Code	Description
Blank	No guards
C	Guards on terminals

c

Head Type‡		
800T Type 4/13	Description	800H Type 4/4X/13
Code		Code
FX	Mushroom head	FRX
FXJ	Jumbo mushroom	FRXJ

d

Operator Function			
Code	Operator Position		
M	Mom.	Main.	Main.
N	Mom.	Main.	Mom.

Mom. – Momentary, Main. – Maintained.

e

Illumination Options	
Transformer	
Code	Description
P	Incandescent
PH	LED
Full Voltage	
Q	Incandescent
QH	Universal LED
Dual Input	
D	Diode type
DT	Transformer — relay type
DTH	Transformer — relay LED

f

Voltage§	
Transformer	
Code	Description
16	120V AC 50/60 Hz
26	240V AC 50/60 Hz
Full Voltage	
24	24V AC/DC
10	120V AC/DC
20	240V AC/DC
Universal LED	
2	12...130V AC/DC
Dual Input	
16	120V AC
24	24V AC/DC▲

g

Color Cap	
Code	Color
X	No cap (not valid with head Type J)
A	Amber
B	Blue
C	Clear
G	Green
R	Red
W	White

h

Target			
Contact			
N.O.	O	O	X
N.C.	X	O	O
N.C.L.B.	X	X	O
Contact Blocks			
Code	Description		
Blank	No contacts on operator		
Standard			
A	1 N.O. - 1 N.C.		
A1	1 N.O. - 1 N.C.L.B.		
A7	1 N.C. - 1 N.C.L.B.		
PenTUFF (Low Voltage)			
AV	1 N.O. - 1 N.C.		
Class 1, Div. 2/Zone 2			
Logic Reed			
AR	1 N.O. - 1 N.C.		
Sealed Switch			
AP	1 N.O. - 1 N.C.		
Stackable Sealed Switch			
AY	1 N.O. - 1 N.C.		

§ See page 10-20 (Table f) for additional voltage code options.

‡ Devices with N.C.L.B. contacts meet EN ISO 13850 and EN/IEC 60947-5-5 standards for emergency stop applications.

⌘ Diode type dual input provides circuit isolation via opposing diodes. Not recommended for use with solid-state outputs.

▲ Dual input diode only.

Potentiometer Devices*❄



Cat. No. 800T-U24



Cat. No. 800H-UR4

Resistance	Type 4/13	Type 4/4X/13	Resistance	Type 4/13	Type 4/4X/13
	Potentiometer‡	Potentiometer‡		Potentiometer‡	Potentiometer‡
	Cat. No.	Cat. No.		Cat. No.	Cat. No.
Operator Only without Resistive Element	800T-N37§	800H-N102§	25 kΩ	800T-U37	800H-UR37
			50 kΩ	800T-U41	800H-UR41
150 Ω	800T-U4	800H-UR4	75 kΩ	800T-U46	800H-UR46
500 Ω	800T-U12	800H-UR12	100 kΩ	800T-U49	800H-UR49
1000 Ω	800T-U13	800H-UR13	150 kΩ	800T-U50	800H-UR50
1500 Ω	800T-U16	800H-UR16	400 kΩ	800T-U54	800H-UR54
2500 Ω	800T-U19	800H-UR19	500 kΩ	800T-U55	800H-UR55
5000 Ω	800T-U24	800H-UR24	1 MΩ	800T-U57	800H-UR57
10 kΩ	800T-U29	800H-UR29	2 MΩ	800T-U59	800H-UR59
15 kΩ	800T-U34	800H-UR34	3 MΩ	800T-U62	800H-UR62
20 kΩ	800T-U35	800H-UR35	4 MΩ	800T-U64	800H-UR64

* Single turn operation with 312° rotation.

❄ Does not meet Class 1 Div. 2 applications.

‡ Rated for 300V AC/DC, 2 W maximum (6V DC minimum). Specify Bulletin 800TC or 800HC for finger-safe potentiometers. Example: Cat. No. 800T-U29 becomes Cat. No. 800TC-U29.

§ For use with Type J potentiometers having a shaft length of 7/8 in. (22.2 mm) and a shaft diameter of 1/4 in. (6.3 mm).

Mechanically Interlocked Maintained Push Button Devices



Cat. No. 800T-FA22A



Cat. No. 800T-FB16A



Cat. No. 800T-FC16F



Cat. No. 800H-CRA22A

Contact Arrangement		Type 4/13			Type 4/4X/13	
		Button Position: Button Type/Color➤			Bootless♣	
Contact Type	Configuration/ Position	Upper: Flush/Black Lower: Flush/Black	Upper: Flush/Green Lower: Extended/ Red	Upper: Flush/Green Lower: Mushroom/ Red	Upper: Flush/Green Lower: Extended/ Red	Upper: Flush/Black Lower: Flush/Black
		Cat. No.	Cat. No.	Cat. No.	Cat. No.	Cat. No.
1 N.O. - 1 N.C.		800T-FA22A	800T-FB16A	800T-FC16A	800H-CRB16A	800H-CRA22A
2 N.O. - 2 N.C.		800T-FA22F	800T-FB16F	800T-FC16F	800H-CRB16F	800H-CRA22F
No Contact	—	800T-FA22	800T-FB16	800T-FC16	800H-CRB16	800H-CRA22

➤ Consult your local Rockwell Automation sales office or Allen-Bradley distributor for other operator types and combinations.

♣ If booted operators are desired, refer to page 10-39 to order boots separately.

Bulletin 800T/H
30.5 mm Push Buttons
 Specialty Operators

Cluster Pilot Light Devices (Bul. 800T Only)*



Color Cap Only With Lamps
 Cat. No. 800T-N249



Complete Unit
 Cat. No. 800T-PC416

Type	Lamp Type	Volts	Type 4/13	
			Color Cap With Lamps Cat. No.	Complete Unit Cat. No.
2-Light Color Cap with Lamps 2 Light 	Incandescent	24V AC/DC Full Voltage	800T-N257	800T-QC224
	LED	24V AC/DC Full Voltage	800T-N257L	800T-QCL224
	Incandescent	120V AC, 50/60 Hz Transformer	800T-N52	800T-PC216
	LED	120V AC, 50/60 Hz Transformer	800T-N52L	800T-PCL216
3-Light Color Cap with Lamps 3 Light 	Incandescent	24V AC/DC Full Voltage	800T-N254	800T-QC324
	LED	24V AC/DC Full Voltage	800T-N254L	800T-QCL324
	Incandescent	120V AC, 50/60 Hz Transformer	800T-N51	800T-PC316
	LED	120V AC, 50/60 Hz Transformer	800T-N51L	800T-PCL316
4-Light Color Cap with Lamps 4 Light 	Incandescent	24V AC/DC Full Voltage	800T-N251	800T-QC424
		120V AC, 50/60 Hz Transformer	800T-N50	800T-PC416

800T - PC 3 16 W R X R
 a b c d e f g h
 Position 1 Position 2 Position 3 Position 4

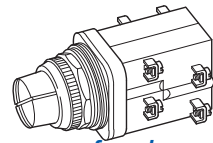

a

Finger-Safe Guards	
Code	Description
Blank	No guards
C	Guards on terminals

b

Power Module Type	
Code	Description
QC	Full voltage
PC	Transformer

c

Illumination Options and No. of Units	
Incandescent	
Code	Description
2	2 unit cluster
3	3 unit cluster
4	4 unit cluster
LED*†‡§	
L2	2 unit cluster
L3	3 unit cluster
L4	4 unit cluster

d

Voltage Options	
Full Voltage	
Code	Description
06	6V AC/DC
12	12V AC/DC
24	24V AC/DC
Transformer	
16	120V AC, 50/60 Hz

e, f, g, h

Color Options	
Code	Color
Blank (All 4 Positions)	Standard unit ▶
X	No color
A	Amber
B	Blue
C	Clear
G	Green
R	Red
W	White

Custom Lens Caps for Cluster Pilot Lights

800T - N249 R G A W
 a b c d e f
 Position 1 Position 2 Position 3 Position 4



a

No. of Lamps/Voltage	
Transformer	
Code	Description
N50	4 lamps, 120V AC, 50/60 Hz
N51	3 lamps, 120V AC, 50/60 Hz
N52	2 lamps, 120V AC, 50/60 Hz
N249	4 lamps, 6V AC/DC
N250	4 lamps, 12V AC/DC
N251	4 lamps, 24V AC/DC
N252	3 lamps, 6V AC/DC
N253	3 lamps, 12V AC/DC
N254	3 lamps, 24V AC/DC
N255	2 lamps, 6V AC/DC
N256	2 lamps, 12V AC/DC
N257	2 lamps, 24V AC/DC

b

Illumination Options	
Code	Description
Blank	Incandescent
L	LED*

c, d, e, f

Code	Description
Blank (All Positions)	Standard unit ▶
A	Amber
B	Blue
C	Clear
G	Green
R	Red
W	White
X	No color

* Rated Type 4/13 indoor only.
 * LEDs are available in red, green and amber only; lens color matches LED color. Exception: the white lens is supplied with an amber LED.
 † White lenses use amber LEDs.
 ‡ LEDs could be adversely affected when used with solid-state outputs.
 § 6V and 12V are positive polarity. 24V LEDs are bipolar.
 ▶ See table above for standard unit colors.



18 mm Small Pilot Lights Type 4/13, Class I, Division 2

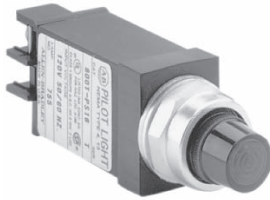

18 mm Pilot Light
 Cat. No. 800T-PS16R

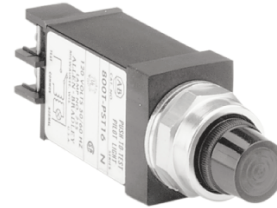

18 mm Push-to-Test Pilot Light
 Cat. No. 800T-PST16R

Type	Lamp	Voltage	Color	Pilot Light	Push-To-Test
				Cat. No.	Cat. No.
Transformer	Incandescent	120V AC 50/60 Hz	Red	800T-PS16R	800T-PST16R
	LED			800T-PSH16R	800T-PSTH16R
Dual Input Diode	Incandescent	120V AC		800T-PSD16R	—
		24V AC/DC		800T-PSD24R	—
Dual Input Transformer	Incandescent	120V AC/DC 50/60 Hz		800T-PSDT16R	—
		24V AC/DC		800T-QS24R	800T-QST24R
Full Voltage	LED	24V AC/DC		800T-QSH24R	800T-QSTH24R
		120V AC		800T-QSH10R	800T-QSTH10R
	Neon	120V AC/DC		800T-RS10A	800T-RST10A

800T – PS D 16 R
 a b c d e

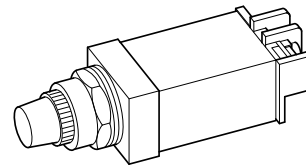

a

Power Module Type	
Code	Description
PS	Transformer (or dual input)
QS	Full voltage
RS	Neon*

b

Lamp Test Options	
Code	Description
Blank	No test option
D	Dual input diode
DT	Dual input transformer relay➤
T	Push-to-test➤

- * Neon is only available in amber or clear.
- ‡ LEDs available in red, green, amber, blue, and white. LED color matches lens color, except clear lens supplied with white LED and white lens supplied with amber LED. All LEDs except 120V have an internal shunt resistor for use with solid-state outputs.
- ♣ Dual input diode only.
- Class 1, Division 2 rating not available. Push-to-test rated for Type 13 only.

c

Illumination Options	
Transformer/Full Voltage/Dual Input	
Code	Description
Blank	Incandescent
H	LED‡
Neon	
Blank	No options

d

Voltage	
Transformer	
Code	Description
16	120V AC 50/60 Hz
26	240V AC 50/60 Hz
Full Voltage Incandescent	
12	12V AC/DC
24	24V AC/DC
Full Voltage LED	
10	120V AC
13	130V AC/DC
24	24V AC/DC
Neon	
10	120V AC/DC
20	240V AC/DC
Dual Input	
16	120V AC 50/60 Hz
24	24V AC/DC♣

e

Lens Color	
Plastic	
Code	Description
Blank	No lens
A	Amber
B	Blue
C	Clear
G	Green
R	Red
W	White

Bulletin 800T/H
30.5 mm Push Buttons
 Specialty Operators

1-, 2-, 3-, 4-Way Toggle Switches (Bul. 800T only)

Switch Type	Lever Movement	Handle Position					Type 4/13	
							Spring Return Operation	Maintained Operation
		Up	Left	Center	Right	Down	Cat. No.	Cat. No.
2 Way		X	—	O	—	O	800T-T2H3EEXX	800T-T2H1EEXX
		O	—	O	—	X		
		—	X	O	O	—		
		—	O	O	X	—		
4 Way		X	O	O	O	O	800T-T4T8AAXX	800T-T4R1AAXX
		O	X	O	O	O		
		O	O	O	X	O		
		O	O	O	O	X		

Note: X = Closed/O = Open

800T — **T2** **H2** **E** **E** **X** **X**
a *b* *c* *d* *e* *f* *g*
 Right Left Right Left

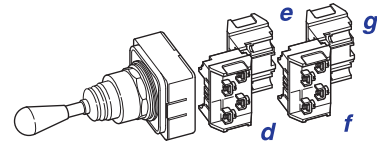

a

Finger-Safe Guards	
Code	Description
Blank	No guards
C	Guards on terminals

b

Operator Type	
Code	Description
T1	1-way toggle
T2	2-way toggle
T3	3-way toggle
T4	4-way toggle

Table 1. Contact Block Code

Contact Block Substitution	
Combination	Code
Standard	
D + E	A
D + D	* M
E + E	N
J + D	B
J + E	C

Table 2. 1-2-3-4 Way Toggle Switch Cam Targets

Contact Configuration Position					Suffix Code Contact/Side	
Up	Left	Center	Right	Down	Right Side	Left Side
O	X	O	O	O	D, H, V, R, 5	—
O	O	O	O	X	E, U, W, S, 6	—
X	O	X	X	X	J, Q	—
X	X	X	X	O	G, I	—
X	O	O	O	O	—	E, U, W, S, 6
O	O	O	X	O	—	D, H, V, R, 5
O	X	X	X	X	—	G, I
X	X	X	O	X	—	J, Q

c

Lever Movement and Function						
Type	Function Code	Description				
		↑	←	→	↓	
1-Way	↑ A	1	M	—	—	
		2	S	—	—	
	← B	1	—	M	—	
		2	—	S	—	
	→ C	1	—	—	M	
		2	—	—	S	
	↓ D	1	—	—	—	M
		2	—	—	—	S
2-Way	↑ E	1	M	M	—	
		2	M	S	—	
		3	S	S	—	
		4	S	M	—	
	← F	1	—	M	M	
		2	—	M	S	
		3	—	S	S	
		4	—	S	M	
→ G	1	—	—	M	S	
	3	—	—	S	S	
	4	—	—	S	M	
	↓ H	1	M	—	—	M
2		M	—	—	S	
3		S	—	—	S	
4		S	—	—	M	
↕ J	1	M	—	M	—	
	2	M	—	S	—	
	3	S	—	S	—	
	4	S	—	M	—	
↔ K	1	—	M	—	M	
	2	—	M	—	S	
	3	—	S	—	S	
	4	—	S	—	M	

c (cont'd)

Lever Movement and Function						
Type	Function Code	Description				
		↑	←	→	↓	
3-Way	↕ L	1	M	M	M	—
		2	M	M	S	—
		3	M	S	M	—
		4	M	S	S	—
		5	S	M	M	—
		6	S	S	M	—
		7	S	M	S	—
		8	S	S	S	—
3-Way	↕ N	1	—	M	M	M
		2	—	M	M	S
		3	—	M	S	M
		4	—	M	S	S
		5	—	S	M	M
		6	—	S	S	M
		7	—	S	M	S
		8	—	S	S	S
3-Way	↕ P	1	M	—	M	M
		2	M	—	M	S
		3	M	—	S	M
		4	M	—	S	S
		5	S	—	M	M
		6	S	—	S	M
		7	S	—	M	S
		8	S	—	S	S
3-Way	↕ Q	1	M	M	—	M
		2	M	M	—	S
		3	M	S	—	M
		4	M	S	—	S
		5	S	M	—	M
		6	S	S	—	M
		7	S	M	—	S
		8	S	S	—	S
4-Way	↕ R	1	M	M	M	M
		2	M	M	M	S
		3	M	M	S	M
		4	M	M	S	S
		5	M	S	M	M
		6	M	S	S	M
		7	M	S	M	S
		8	M	S	S	S
4-Way	↕ T	1	S	M	M	M
		2	S	M	M	S
		3	S	M	S	M
		4	S	M	S	S
		5	S	S	M	M
		6	S	S	S	M
		7	S	S	M	S
		8	S	S	S	S

Contact Blocks	
Code	Description
Blank (all pos.)	No contacts
Standard	
D	1 N.O.
E	1 N.C.
G	1 N.O.E.M.
J	1 N.C.L.B.
A	1 N.O. - 1 N.C.
X	No contacts in this position
PenTUFF (Low Voltage)	
H	1 N.O.
U	1 N.C.
I	1 N.O.E.M.
Q	1 N.C.L.B.
F	1 N.O. - 1 N.C.
Class 1, Div. 2/Zone 2	
Logic Reed	
V	1 N.O.
W	1 N.C.
T	1 N.O. - 1 N.C.
Sealed Switch	
R	1 N.O.
S	1 N.C.
P	1 N.O. - 1 N.C.
Stackable Sealed Switch	
5	1 N.O.
6	1 N.C.
7	1 N.O. - 1 N.C.

Note: M = Maintained, S = Spring Return
 * **XA2** and **XA2R** contact blocks cannot be stacked upon, but they can stack on other contact blocks.

Selector Push Button Devices (Bul. 800T only)



Selector Push Button
 Cat. No. 800T-K2AAXX

Contact Type	Button Color	Button Type	Contact Position	Selector Sleeve Left		Selector Sleeve Right		Type 4/13 Selector Push Button
				Button Free	Button Depressed	Button Free	Button Depressed	Cat. No.
 1 N.O. - 1 N.C.	Black	Flush	Right	O	X	O	O	800T-KE2DEXX
			Left	O	O	X	O	
 2 N.O. - 2 N.C.	Black	Flush	Right	O	X	O	X	800T-K2AAXX
			Left	O	X	O	X	
 1 N.O. - 1 N.C.	Black	Flush	Right	O	X	O	X	800T-KC2AAXX
			Left	O	O	X	O	

Note: X = Closed/O = Open

800T **- KD** **2** **G** **J** **D** **E**
a *b* *c* *d* *e* *f* *g*
 Right Left Right Left

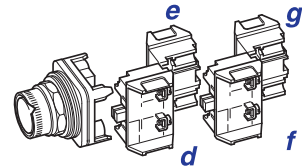

d, e, f, g (cont'd)

Finger-Safe Guards

Code	Description
Blank	No guards
C	Guards on terminals

Cam and Head Type

Code	Description
K	A cam with flush operator
KA	A cam with extended operator
KB	B cam with flush operator
KC	C cam with flush operator
KD	D cam with flush operator
KE	E cam with flush operator

Note: See Table 1 for Target description of each cam.

Color Cap

Code	Color
1	Green
2	Black
6	Red

Contact Blocks

Code	Description
Blank (all pos.)	No contacts on operator
Standard	
D	1 N.O.
E	1 N.C.
G	1 N.O.E.M.
J	1 N.C.L.B.
A	1 N.O. - 1 N.C.
X	No contacts in this position
PenTUFF (Low Voltage)	
H	1 N.O.
U	1 N.C.
I	1 N.O.E.M.
Q	1 N.C.L.B.
F	1 N.O. - 1 N.C.

Contact Blocks

Code	Description
Class 1, Div. 2/Zone 2	
Logic Reed	
V	1 N.O.
W	1 N.C.
T	1 N.O. - 1 N.C.
Sealed Switch	
R	1 N.O.
S	1 N.C.
P	1 N.O. - 1 N.C.
Stackable Sealed Switch	
5	1 N.O.
6	1 N.C.
7	1 N.O. - 1 N.C.

Table 2. Contact Block Reduction Rules

Contact Block Substitution	
Standard	
Combination	Substitute Code
D + E	A
D + D	M*
E + E	N
J + D	B
J + E	C

Table 1. Selector Push Button Cam Targets (Note: X = Closed/O = Open)

Sleeve Position				Cam Description											
				KA/K		KB		KC		KD		KE			
Button Free	Button Pressed	Button Free	Button Pressed	Right		Left		Right		Left		Right		Left	
O	O	O	X	—	—	—	D, H, V, R, 5	—	D, H, V, R, 5	—	—	—	—	—	—
O	O	X	O	E, U, W, S, 6	E, U, W, S, 6	—	—	—	—	—	E, U, W, S, 6	—	E, U, W, S, 6	—	E, U, W, S, 6
O	O	X	X	—	—	—	—	—	—	—	E, U, W, S, 6	—	E, U, W, S, 6	—	—
O	X	O	O	—	—	—	—	D, H, V, R, 5	—	D, H, V, R, 5	—	D, H, V, R, 5	—	D, H, V, R, 5	—
O	X	O	X	D, H, V, R, 5	D, H, V, R, 5	D, H, V, R, 5	—	—	—	—	D, H, V, R, 5	—	D, H, V, R, 5	—	D, H, V, R, 5
O	X	X	O	—	—	—	—	—	—	—	—	—	—	—	—
X	O	X	O	J or Q	J or Q	E, U, W, S, 6	—	—	—	—	—	J or Q	—	J or Q	
X	X	O	O	—	—	—	—	—	—	—	G or I	—	G or I	—	G or I
X	X	O	X	G or I	G or I	—	—	—	—	—	—	G or I	—	G or I	
X	O	X	X	—	—	—	—	E, U, W, S, 6	—	—	J or Q	—	J or Q	—	—
X	X	X	O	—	—	—	E, U, W, S, 6	—	E, U, W, S, 6	—	—	—	—	—	—



Bulletin 800T/H
30.5 mm Push Buttons
 Specialty Operators

Cylinder Lock Push Button Devices (Bul. 800T only)



Cylinder Lock Push Button
 Cat. No. 800T-E15A



Mushroom Style Cylinder Lock
 Cat. No. 800T-E15M6A

Type of Cylinder Lock	Lock Position	Type 4/13	
		Standard Cylinder Lock	Red Mushroom Cylinder Lock
		Cat. No.*	Cat. No.*❖
Spring Bolt — Lock can be set with key when button is in the OUT position. Button will lock when depressed. Key removable in any position. 1 N.O. - 1 N.C.	IN	800T-E15A	800T-E15M6A
Dead Bolt A — Button can only be operated with the key in the lock. Key removable in locked position only. 1 N.O. - 1 N.C.	IN	800T-E24A	800T-E24M6A
	OUT	800T-E14A	800T-E14M6A
Dead Bolt B — Button can be operated with or without the key inserted in the lock. Key removable in any position. 1 N.O. - 1 N.C.	IN	800T-E12A	800T-E12M6A
	OUT	800T-E11A	800T-E11M6A

* Each device supplied with 2 keys. Replacement key part no. for standard E158 is X-144218.

❖ For jumbo size mushroom cap, change **M** to **J**. Example: Cat. No. 800T-E15M6A becomes Cat. No. 800T-E15J6A.

Momentary Padlocking Mushroom Head Devices (Bul. 800T only) ‡



Padlocking Mushroom Button
 Cat. No. 800T-D6QA



Padlocking Jumbo Mushroom Button
 Cat. No. 800T-D6LQA

Contact Type	Button Color	Type 4/13	
		Standard Size Metal Mushroom Head	Jumbo Size Metal Mushroom Head
		Cat. No.§	Cat. No.§
No Contact	Red	800T-D6Q	800T-D6LQ
1 N.O.		800T-D6QD1	800T-D6LQD1
1 N.C.		800T-D6QD2	800T-D6LQD2
1 N.O. - 1 N.C.		800T-D6QA	800T-D6LQA

‡ Allows locking in the depressed position. Will hold N.C. contacts open, but might not hold N.O. contacts closed.

§ To order without the padlocking attachment, change **Q** to **F**. Example: Cat. No. 800T-D6QA becomes Cat. No. 800T-D6FA

Momentary Wobble Stick Push Button Devices (Bul. 800T Type 13 only)



Wobble Stick Unit
 Cat. No. 800T-M1B

Contact Type	Wobble Stick♣
No Contacts	Cat. No. 800T-M1
1 N.O.	800T-M1D1
1 N.O. - 1 N.C.	800T-M1A
2 N.O. - 2 N.C.	800T-M1B

♣ Can be operated from any angle.

Momentary Contact Flip Lever Devices (Bul. 800H Type 4/4X only)



Flip Lever Operator
Cat. No. 800H-WK42B



Flip Lever Operator
Cat. No. 800H-WK61B

Contact Type	Button Color	Legend Marking	Flip Lever Cat. No.
No Contacts	Grey	START	800H-WK42
		No Legend*	800H-WK4
	Red*	STOP	800H-WK61
		No Legend*	800H-WK6
 1 N.O. - 1 N.C.	Grey	START	800H-WK42A
		No Legend*	800H-WK4A
	Red*	STOP	800H-WK61A
		No Legend*	800H-WK6A
 2 N.O. - 2 N.C.	Grey	START	800H-WK42B
		No Legend*	800H-WK4B
	Red*	STOP	800H-WK61B
		No Legend*	800H-WK6B

* Legend plate can be ordered separately. Refer to accessories section.
* Locking provision is supplied as standard on red units.

800H — WK 6 1 A
 a b c d

a

Finger-Safe Guards	
Code	Description
Blank	No guards
C	Guards on terminals

b

Operator Color	
Code	Description
4	Grey
6	Red

c

Operator Types			
Code	Description	Code	Description
—	Blank	20	OUT
1	STOP	21	RAISE
2	START	22	RESET
3	CLOSE	23	REVERSE
4	DOWN	24	RIGHT
5	EMERG. STOP	25	RUN
6	FAST	26	SECOND SPEED
7	FORWARD	27	SLOW
8	FULL SPEED	28	TEST
9	HIGH	29	THIRD SPEED
10	IN	30	UP
11	INCH	31	O
12	JOG	32	I
13	LEFT	33	AVANT
14	LOW	34	OUVRIER
15	LOW SPEED	35	ARRIER
16	LOWER	36	MARCHE
17	OFF	37	ESSAI
18	ON	38	ARRET
19	OPEN		

d

Contact Block(s)	
Code	Description
Blank	No contacts
Standard	
D1	1 N.O.
D2	1 N.C.
D3	1 N.O.E.M.
D4	1 N.C.L.B.
D5	1 N.O. (Mini)
D6	1 N.C. (Mini)
A1	1 N.C.L.B. - 1 N.O.
A2	2 N.O.
A4	2 N.C.
A7	1 N.C.L.B. - 1 N.C.
A	1 N.O. - 1 N.C.
B	2 N.O. - 2 N.C.
Class 1, Div. 2/Zone 2	
Sealed Switch	
D1P	1 N.O.
D2P	1 N.C.
AP	1 N.O. - 1 N.C.
BP	2 N.O. - 2 N.C.
Stackable Sealed Switch	
D1Y	1 N.O.
D2Y	1 N.C.
A2Y	2 N.O.
A4Y	2 N.C.
AY	1 N.O. - 1 N.C.
BY	2 N.O. - 2 N.C.





d (cont'd)

Contact Block(s)	
Code	Description
PenTUFF (Low Voltage)	
D1V	1 N.O.
D2V	1 N.C.
D3V	1 N.O.E.M.
D4V	1 N.C.L.B.
AV	1 N.O. - 1 N.C.
BV	2 N.O. - 2 N.C.
Class 1, Div. 2/Zone 2	
Logic Reed	
D1R	1 N.O.
D2R	1 N.C.
A2R	2 N.O.†
A4R	2 N.C.
AR	1 N.O. - 1 N.C.
BR	2 N.O. - 2 N.C.









Bulletin 800T/H
30.5 mm Push Buttons
 Specialty Operators

Break-Glass Push Button Stations (Bul. 800T only)
 Complete Station

	Description	Contact Type	Cat. No.
 <i>Cat. No. 800T-NX114</i>	Break-Glass Push Button Station Red push button station in a Type 4/13 enclosure incorporates either one or two snap-action contact blocks, which are operated when the small glass window is broken. Includes STOP legend.	 1 N.O. - 1 N.C.	800T-NX114
		  2 N.O. - 2 N.C.	800T-NX115

Miscellaneous Kits

	Description	Contact Type	Cat. No.
 <i>Cat. No. 800T-S6M</i>	Unit Only Kit The break-glass unit less the enclosure is available as a kit to install into the customer's enclosure. The kit includes the contact unit, the hammer and chain and five extra glass discs with one button tack. This kit does not include legend plate. For legend plates, see page 10-48.	 1 N.O. - 1 N.C.	800T-S6M
		 2 N.O. - 2 N.C.	800T-S6N
 <i>Cat. No. 800T-NXM</i>	Replacement Snap Action Contact Block Kit This kit is used to replace the snap action contact block.	 1 N.O. - 1 N.C.	800T-NXM
		 2 N.O. - 2 N.C.	800T-NXN
 <i>Cat. No. 800T-N28</i>	Glass Disc Kit Each replacement kit for break-glass push button units or stations consists of six glass discs and one button tack.	Description	Cat. No.
			800T-N28

10

Approximate Dimensions

Dimensions in inches (millimeters). Dimensions are not intended to be used for manufacturing purposes.

Break-Glass Station

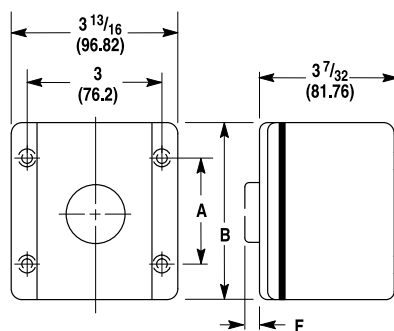

A = 2 3/4 (69.85)
 B = 4 3/16 (106.38)
 F = 9/16 (14.28)



Custom-Built Stations



Description

The table on page 10-5 lists the most commonly used Bulletin 800T/800H push button stations. Stations not listed in this table may be ordered as custom-built stations.

Cat. No.





The cat. no. used to identify custom-built Bulletin 800T push button stations will be cat. no. listed for enclosure only. The letter **Z** will be substituted for the letter **W** and a station serial no. will be added.

Ordering Information

The following information is required when ordering custom-built push button stations.

1. Cat. no. of enclosure.
2. Cat. no. of control units.
3. Legend plate cat. no. and/or marking for each unit.
4. Specify vertical/horizontal mounting.
5. Specify desired operator mounting sequence. Inclusion of a sketch is recommended. If no information is given, standard configuration will be used.

Enclosures

No. of Operator Openings	Surface Mount*		Flush Mount	Pendant Type	
	Die Cast* (Type 4/13)	Sheet Metal (Type 13)	Die Cast Face Plate (Type 4/13)	One Hole in Bottom (Type 13)	Openings in Cover (Type 13)
	 <i>Cat. No. 800T-2TZ</i>	 <i>Cat. No. 800T-6TJZ</i>	 <i>Cat. No. 800T-2ZT</i>	 <i>Cat. No. 800T-2PZ</i>	 <i>Cat. No. 800T-2PY</i>
	Cat. No.	Cat. No.	Cat. No.	Cat. No.	Cat. No.
1	800T-1TZ *	—	800T-1ZT	—	—
2	800T-2TZ *	—	800T-2ZT	800T-2PZ	800T-2PY
3	800T-3TZ *	—	800T-3ZT	800T-3PZ	800T-3PY
4	800T-4TZ *	—	800T-4ZT	800T-4PZ	800T-4PY
5	—	—	—	800T-5PZ	800T-5PY
6‡	800T-6TZ *	—	800T-6ZT	800T-6PZ	800T-6PY
6§	800T-6THZ *	800T-6TJZ	800T-6ZTH	—	—
7	—	—	—	800T-7PZ	800T-7PY
8	—	—	—	800T-8PZ	800T-8PY
9	800T-9TZ	800T-9TJZ	800T-9ZT	800T-9PZ	800T-9PY
10	—	—	—	800T-10PZ	800T-10PY
12	800T-12TZ	800T-12TJZ	800T-12ZT	—	—
16	800T-16TZ	800T-16TJZ	800T-16ZT	—	—
20	—	800T-20TJZ	—	—	—
25	—	800T-25TJZ	—	—	—

Note: Specialty enclosures available. Please refer to KB Q69259778.

Note: Enclosure and conduit dimensions are detailed on page 10-61.

* Bottom conduit entry. Grounding provision provided.

* Enclosure depth will accommodate one shallow and one mini-contact block stacked.

* Add suffix **Y** to the cat. no. for yellow painted enclosure. Example: **Cat. No. 800T-1TZY**.

‡ One vertical row.

§ Two vertical rows of three holes.

Custom-Built Stations (800H only)



Cat. No.

The cat. no. used to identify custom-built Bulletin 800H push button stations will be cat. no. listed for enclosure only. The letter **W** is substituted for the letter **Z** and a station serial no. will be added.

Ordering Information

The following information is required when ordering custom-built push button stations:

1. Cat. no. of enclosure.
2. Cat. no. of control units.
3. Legend plate cat. no. and/or marking for each unit.
4. Specify vertical/horizontal mounting.
5. Specify operator mounting sequence that you want. Including a sketch is recommended. If information not given, standard configuration will be used.

Enclosures (800H only)

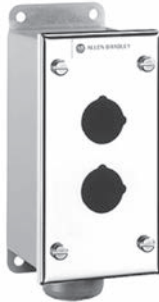

Stainless Steel
Cat. No. 800H-2HZ4



Rosite Glass Polyester
Cat. No. 800H-2HZ4R



Fiberglass
Cat. No. 800H-2HZ4Y



Thermoplastic Polyester
Cat. No. 800H-2HZ4C

No. of Operator Openings	Conduit Hubs		Stainless Steel (#304) Type 4/4X/13*	Rosite Glass Polyester Type 4/4X/13	No. of Operator Openings	Conduit Openings		Fiberglass* Type 4/4X/13	Thermoplastic Polyester* Type 4/4X
	No.	Dia. [in.]	Cat. No.	Cat. No.		No.	Dia. [in.]‡	Cat. No.	Cat. No.
0§	1	3/4	800H-0HZ4	—	1	1	3/4	800H-1HZ4Y	800H-1HZ4C
1	1	3/4	800H-1HZ4	800H-1HZ4R	2	1	1	800H-2HZ4Y	800H-2HZ4C
1	2	3/4	—	800H-1HZ4RM1	3	1	1	800H-3HZ4Y	800H-3HZ4C
1	1	1	—	800H-1HZ4RM2	4	—	—	—	800H-4HZ4C
2	1	3/4	800H-2HZ4	800H-2HZ4R	—	—	—	—	—
2	2	3/4	800H-2HZ4M1	800H-2HZ4RM1	—	—	—	—	—
2	1	1	800H-2HZ4M2	800H-2HZ4RM2	—	—	—	—	—
3	1	3/4	800H-3HZ4	800H-3HZ4R	—	—	—	—	—
3	2	3/4	800H-3HZ4M1	800H-3HZ4RM1	—	—	—	—	—
4	1	3/4	800H-4HZ4	800H-4HZ4R	—	—	—	—	—
4	2	3/4	800H-4HZ4M1	800H-4HZ4RM1	—	—	—	—	—
5	1	1	800H-5HZ4	—	—	—	—	—	—
6	1	1	800H-6HZ4	800H-6HZ4R	—	—	—	—	—
7	1	1	800H-7HZ4	—	—	—	—	—	—
8	1	1	800H-8HZ4	—	—	—	—	—	—

Note: Other combinations of conduit hub sizes are available upon request. Enclosure and conduit dimensions are detailed on page 10-61.

* Grounding screw provided with stainless steel enclosure.

⊗ Extra deep. Accommodates two levels of stackable sealed switch contact blocks.

‡ Conduit hubs must be ordered separately. For 3/4 in. hub, order **Cat. No. 1490-N9**. For 1 in. hub, order **Cat. No. 1490-N10**.

§ Identical to **Cat. No. 800H-1HZ4** but without mounting holes.

♣ No conduit openings provided.

➤ Yellow thermoplastic enclosures may be ordered by adding a **Y** to the cat. no. Example: **Cat. No. 800H-1HZ4C** becomes **Cat. No. 800H-1HZ4CY**.

Contact Blocks

Packaged in kit form for field installation. All necessary mounting hardware is provided with each contact block kit. **Contact ratings are listed on page 10-4.**

Note: It is not recommended to mount more than four contact blocks on any one non-illuminated operator (maximum two blocks deep). Contact blocks cannot be stacked onto power modules, so illuminated operators are limited to two contact blocks. Sealed switch contact blocks are not stackable and are limited to two blocks per operator. Time delay contacts are only available as one circuit per operator.

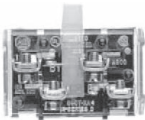

Shallow Block

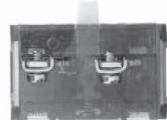

PenTUFF™ (Low Voltage) Contact Block



Logic Reed Block



Sealed Switch Block

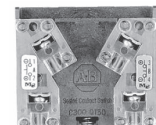

Stackable Sealed Switch Block

Contact Type	Shallow Block**		PenTUFF (Low Voltage) Block**		Logic Reed Block‡		Sealed Switch Block‡		Stackable Sealed Switch Block‡	
	Cat. No.	Code	Cat. No.	Code	Cat. No.	Code	Cat. No.	Code	Cat. No.	Code
1 N.O.	800T-XD1	D	800T-XD1V	H	800T-XD1R	V	800T-XD1P	R	800T-XD1Y	5
1 N.C.	800T-XD2	E	800T-XD2V	U	800T-XD2R	W	800T-XD2P	S	800T-XD2Y	6
1 N.O.E.M.	800T-XD3	G	800T-XD3V	I	—	—	—	—	—	—
1 N.C.L.B.	800T-XD4	J	800T-XD4V	Q	—	—	—	—	—	—
1 N.O. - N.C.	800T-XA	A	800T-XAV	F	800T-XAR	T	800T-XAP	P	800T-XAY	7
2 N.O.	800T-XA2§	M	—	—	800T-XA2R§	Y	—	—	800T-XA2Y	8
2 N.C.	800T-XA4	N	—	—	800T-XA4R	Z	—	—	800T-XA4Y	9
1 N.C.L.B. - 1 N.O.	800T-XA1	B	—	—	—	—	—	—	—	—
1 N.C.L.B. - 1 N.C.	800T-XA7	C	—	—	—	—	—	—	—	—

Note: Modular suffix codes can be used when specifying selector switches with multiple contact blocks.



Self Monitoring Contact Block

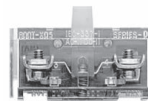

Mini Block



Time Delay Block



MaxDuty Block

Contact Type	S.M.C.B.*>	
	Cat. No.	Code
1 N.C.L.B. (wired in series with 1 N.O. monitoring contact)	800TC-XD4S	3

Contact Type	Mini Block*		Time Delay Block*	MaxDuty Block	
	Cat. No.	Code	Cat. No.	Cat. No.	Code
1 N.O.	800T-XD5	K	800T-XT	800T-XD1M	1
1 N.C.	800T-XD6	L	800T-XS	800T-XD2M	2
1 N.C.L.B.	—	—	—	800T-XD4M	4

Note: Modular suffix codes can be used when specifying selector switches with multiple contact blocks.

* Contact blocks with normally closed contacts meet direct drive positive opening standard requirements when properly fused to IEC 269-1 and 269-2. Shallow/mini contacts: 10 A gl or N type cartridge fuse. PenTUFF contacts: 6 A gl or N type cartridge fuse.

** Specify Bulletin 800TC for finger-safe contact blocks. Example: **Cat. No. 800T-XA** becomes **Cat. No. 800TC-XA**.

‡ 800T operator using sealed switch and logic reed contact blocks and installed in a suitable enclosure are UL Listed as suitable for use in Class I, Division 2/Zone 2 hazardous locations.

§ Additional contacts cannot be stacked on XA2 and XA2R contact blocks.

♣ For contact ratings, see page 10-4.

> For use with 2-position push-pull or push-pull/twist operators only. Must be mounted on the first level of the operator. The N.O. monitoring contact automatically closes when the S.M.C.B. is properly installed onto the operator. If the S.M.C.B. is separated from the operator, the N.O. monitoring contact automatically opens.

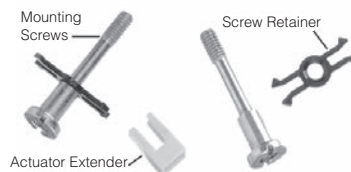

Shallow Contact Block Hardware

Description	Cat. No.
Contact Block Mounting Screw	800T-N335
Screw Retainer	800T-N336
Actuator Extender	800T-N337

Bulletin 800T/H
30.5 mm Push Buttons
 Accessories

Power Modules

Packaged in kit form for field installation. Lamps are listed on page 10-45.

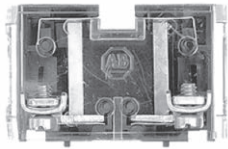

Full Voltage Power Module
 Cat. No. 800T-N330



Transformer Power Module
 Cat. No. 800T-N326

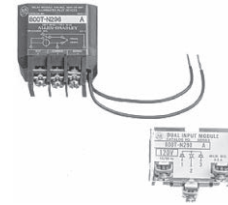

Dual Input Power Modules
 Cat. No. 800T-N296 (Transformer)
 Cat. No. 800T-N290N (Diode)

Full Voltage§		Transformer§		Dual Input		
Lamp Voltage	Cat. No.	Voltage	Cat. No.	Type	Voltage	Cat. No.
6...130V AC/DC	800T-N330	48V AC 50/60 Hz	800T-N325	Transformer*	120V AC	800T-N296
		120V AC 50/60 Hz	800T-N326	Diode Type*	24V AC/DC	800T-N291N
		240V AC 50/60 Hz	800T-N327		120V AC/DC	800T-N290N
		277V AC 50/60 Hz	800T-N327Y		—	—
		480V AC 50/60 Hz	800T-N328	—	—	
240V AC/DC‡	800T-N331	600V AC 50/60 Hz	800T-N329	—	—	—

* Transformer type dual input provides circuit isolation via a miniature type relay. This module is used in conjunction with a 120V transformer.

* Diode type dual input provides circuit isolation via opposing diodes. Not recommended for use with solid-state outputs and neon indicators.

‡ 240V full voltage module contains 50% dropping resistors for use with a 120V incandescent lamp.

§ Specify Bulletin 800TC for finger-safe power modules. Example: **Cat. No. 800T-N330** becomes **Cat. No. 800TC-N330**.

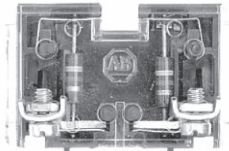

Resistor Power Module
 Cat. No. 800T-N332

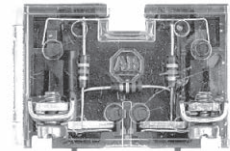

Neon Power Module
 Cat. No. 800T-N333

Resistor (10% Drop)➤		Neon♣➤	
Voltage	Cat. No.	Voltage	Cat. No.
120V AC/DC	800T-N332	120V AC/DC	800T-N333
		240V AC/DC	800T-N334

♣ Neon modules contain resistors.

➤ Specify Bulletin 800TC for finger-safe power modules. Example: **Cat. No. 800T-N332** becomes **Cat. No. 800TC-N332**.

Universal LED Module



Voltage	Cat. No.
12...130V AC/DC	800TC-N374

10

Trigger Action E-Stop Latches



Cat. No. 800T-N380



Cat. No. 800T-N379

Description	Cat. No.
Illuminated type	800T-N380
Non-illuminated type	800T-N379

Replacement Color Caps

Color caps listed below are for field replacement on installed devices or for completion of devices ordered with color caps omitted.



Push-Pull



Push-Pull/Twist



Push-Pull Jumbo



Push-Pull/Twist Jumbo

Push-Pull Color Caps, Illuminated

Color	800T Push-Pull	800H Push-Pull	800T/H Push-Pull/Twist	800T/H Push-Pull Jumbo	800T/H Push-Pull/Twist Jumbo
	Cat. No.	Cat. No.	Cat. No.	Cat. No.	Cat. No.
Amber	800T-N159A	800H-N112A	800T-N301A	800T-N209A	800T-N306A
Blue	800T-N159B	800H-N112B	800T-N301B	800T-N209B	800T-N306B
Clear	800T-N159C	800H-N112C	800T-N301C	800T-N209C	800T-N306C
Green	800T-N159G	800H-N112G	800T-N301G	800T-N209G	800T-N306G
Red	800T-N159R	800H-N112R	800T-N301R	800T-N209R	800T-N306R
White	800T-N159W	800H-N112W	800T-N301W	800T-N209W	800T-N306W



Illuminated Mushroom



Illuminated Jumbo Mushroom



Standard



Push-to-Test



Glass Caps for Pilot Lights

Color	800T/H Push Button Color Caps, Illuminated		800T/H Pilot Light Color Caps			Glass Caps for 800T Pilot Lights
	Mushroom	Jumbo Mushroom	Standard*	Push-to-Test*	18 mm	
	Cat. No.	Cat. No.	Cat. No.	Cat. No.	Cat. No.	
Amber	800T-N304A	800T-N305A	800T-N26A	800T-N42	800T-N122A	800T-N22
Blue	800T-N304B	800T-N305B	800T-N26B	800T-N43	800T-N122B	800T-N23
Clear	800T-N304C	800T-N305C	800T-N26C	800T-N45	800T-N122C	800T-N25
Green	800T-N304G	800T-N305G	800T-N26G	800T-N41	800T-N122G	800T-N21
Red	800T-N304R	800T-N305R	800T-N26R	800T-N40	800T-N122R	800T-N20
White	800T-N304W	800T-N305W	800T-N26W	800T-N44	800T-N122W	800T-N24

* Available in bulk quantities of 20. Add suffix (-BP) to the cat. no. and order in multiples of 20.



Plastic Mushroom



Plastic Jumbo Mushroom



Padlocking Metal Mushroom



Metal Jumbo Mushroom

Push Button Color Caps, Non-Illuminated

Button Color	800T Plastic Mushroom	800H Plastic Mushroom	800T Plastic Jumbo Mushroom	800H Plastic Jumbo Mushroom	800T Padlocking Metal Mushroom	800T Metal Jumbo Mushroom	
	Cat. No.	Cat. No.	Cat. No.	Cat. No.	Cat. No.		Cat. No.
Red	800T-N246R	800H-N114A	800T-N247R	800H-N115A	800T-N311R	*	800T-N248R
Green	800T-N246G	800H-N114B	800T-N247G	800H-N115B	800T-N311G	*	800T-N248G
Black	800T-N246B	800H-N114H	800T-N247B	800H-N115H	800T-N311B	*	800T-N248B
Orange	800T-N246O	800H-N114F	800T-N247O	800H-N115F	800T-N311O	⊛	800T-N248O
Grey	800T-N246GR	800H-N114G	800T-N247GR	800H-N115G	800T-N311GR		800T-N248GR
Blue	800T-N246BL	800H-N114C	800T-N247BL	800H-N115C	800T-N311BL	*	800T-N248BL
Yellow	800T-N246Y	800H-N114E	800T-N247Y	800H-N115E	800T-N311Y	*	800T-N248Y
Natural	—	—	—	—	—	‡	800T-N248
White	800T-N246W	800H-N114L	—	800H-N115L	—		—

For padlocking jumbo mushroom style:

* change listed cat. no. from **248** to **313**. Example: **Cat. No. 800T-N248G** becomes **Cat. No. 800T-N313G**.

⊛ change listed cat. no. from **Cat. No. 800T-N248O** to **Cat. No. 800T-N313**.

‡ change listed cat. no. from **Cat. No. 800T-N248** to **Cat. No. 800T-N313GR**.

Bulletin 800T/H
30.5 mm Push Buttons
 Accessories

Replacement Color Caps, Continued

Color caps listed below are for field replacement on installed devices or for completion of devices ordered with color caps omitted.



Push-Pull



Push-Pull/Twist



Push-Pull Jumbo



Push-Pull/Twist Jumbo

Button Color	800T/H Push-Pull Color Caps, Non-Illuminated			
	Push-Pull	Push-Pull/Twist	Push-Pull Jumbo	Push-Pull/Twist Jumbo
	Cat. No.	Cat. No.	Cat. No.	Cat. No.
Red	800T-N160A	800T-N302A	800T-N208A	800T-N307A
Green	800T-N160B	800T-N302B	800T-N208B	800T-N307B
Blue	800T-N160C	800T-N302C	800T-N208C	800T-N307C
Yellow	800T-N160E	800T-N302E	800T-N208E	800T-N307E
Orange	800T-N160F	800T-N302F	800T-N208F	800T-N307F
Grey	800T-N160G	800T-N302G	800T-N208G	800T-N307G
Black	800T-N160H	800T-N302H	800T-N208H	800T-N307H
White	800T-N160L	800T-N302L	800T-N208L	800T-N307L

Selector Switch Knobs, Illuminated



Standard Knob



Knob Lever

Color	800T Knob Type		800H Knob Type	
	Standard Knob	Knob Lever	Standard Knob	Knob Lever
	Cat. No.	Cat. No.	Cat. No.	Cat. No.
Amber	800T-N297A	800T-N298A	800H-N154A	800H-N155A
Blue	800T-N297B	800T-N298B	800H-N154B	800H-N155B
Clear	800T-N297C	800T-N298C	800H-N154C	800H-N155C
Green	800T-N297G	800T-N298G	800H-N154G	800H-N155G
Red	800T-N297R	800T-N298R	800H-N154R	800H-N155R
White	800T-N297W	800T-N298W	800H-N154W	800H-N155W

Selector Switches

Standard Knob Lever	Coin Slot Wing Lever	Description	Item	Color	Cat. No.
				<p>800T Knobs and Actuators for Selector Switches Selector switch knobs can be changed in the field. Standard knob and knob levers can be ordered with white inserts or with a packet of colored inserts which includes one insert of each color.</p>	<p>800T Knob</p>
Knob Lever	Kit	800T-N230			
	White	800T-N231F			
Wing Lever	Kit	800T-N231			
	Grey	800T-N238			
Coin Slot	Red	800T-N238A			
	Black Only	800T-N239			
	<p>800H Knob</p>	<p>800T/H Color Insert Kits Available on Selector switches with removable color inserts. Standard knob and knob levers use the same insert. If color All is selected, a packet of color inserts will be furnished which includes one of each color. Color Insert kits can also be ordered with operators at no additional charge.</p>	Standard Knob	White	800H-N145F
			<p>800T/H Color Insert Kits</p>	Red	800T-N124
				Green	800T-N125
				Blue	800T-N126
				Yellow	800T-N127
				White	800T-N128
				Orange	800T-N286
				All	800T-N123

Booted Selector Switch Knobs, Non-Illuminated (800H only)



Cat. No. 800H-NR5

Insert Material	Material			
	Chlorosulfonated Polyethylene ‡	Silicone • ‡	Urethane •• ‡	Ethylene • Propylene •• ‡
	Cat. No.	Cat. No.	Cat. No.	Cat. No.
Brass *	800H-NR5	800H-NR101	800H-NR100	800H-NR103
Stainless Steel	800HS-NR5	800HS-NR101	800HS-NR100	800HS-NR103

* Color insert packet (Cat. No. 800T-N123) is included in each kit.
 ‡ Dots printed on the inside of the boot identify the boot material.

Protective Boots

Protective Boot for Illuminated Push Buttons



Cat. No. 800H-N11



Cat. No. 800H-N12

Description	Type	Cat. No.
May be added to guarded units, units without guard or Push-to-Test devices. This protective boot guards against the entrance of foreign materials reaching the opening between the button and locking ring.	Boot without Guard	800H-N11
	Boot with Guard	800H-N12

Protective Boots for Non-Illuminated Push Buttons*

Boots supplied with control stations and components are made of a chlorosulfonated polyethylene material with stainless steel insert ring. To order boots with silicone, urethane, or ethylene propylene material, see the table below. Material application information shown below.



Cat. No. 800H-N5A

Insert Material	Boot Color	Material			
		Chlorosulfonated Polyethylene ‡	Silicone • ‡	Urethane •• ‡	Ethylene • Propylene •• ‡
		Cat. No.	Cat. No.	Cat. No.	Cat. No.
Stainless steel §	Red	800H-N5A	800H-N101R	800H-N100R	800H-N103R
	Green	800H-N5B	800H-N101G	800H-N100G	800H-N103G
	Black	800H-N5H	800H-N101B	800H-N100B	800H-N103B
	Yellow	800H-N5E	800H-N101Y	800H-N100Y	—
	Blue	800H-N5C	800H-N101BL	800H-N100BL	—

* May be added to flush or extended head push button units to protect against foreign materials reaching the opening between the button and the locking ring.
 § Series B boots incorporate a stainless steel insert as standard.
 ‡ Dots printed on the inside of the boot identify the boot material.

Protective Boot Application Information

– **Chlorosulfonated Polyethylene (synthetic rubber)**

Very resistant to attack by oxidizing chemicals such as concentrated sulfuric acid and hypochlorite solutions. Also resistant to attack by oils and performs well in a wide range of other chemicals and solvents. Good flex and high impact resistance. This is the standard boot material supplied with 800H NEMA Type 4/4X push buttons unless otherwise specified.

– **Silicone**

Superior high temperature resistance. Particularly suited for use where organic acids or vegetable oils may be present. Also superior resistance to the effects of outdoor use, such as oxygen, ozone, and weather.

– **Urethane**

Excellent resistance to mechanical failure. Most durable boot material. Particularly suited for use where lubricating oils and automotive fuels may be present. Also well-suited for outdoor use.



– **Ethylene-propylene**

Particularly suited for high temperature applications. Resistant to attack by many acids and alkalis, detergents, phosphate esters, ketones, alcohols, and glycols. Outstanding service in areas with hot water and steam wash downs.





Potentiometer Replacement Knobs

Description	Cat. No.
Type 4/13 (800T)	40274-073-55
Type 4/4X/13 (800H)	40274-073-54





Push Buttons

	Description	Cat. No.
 Cat. No. 800T-N179 <i>(Operators not included)</i>	Bul. 800T/H Mechanical Interlock Used on momentary contact push button units. Guards against closing the N.O. contacts of one button while the other button's N.O. contacts are closed. Buttons remain momentary. For maintained units, see page 10-25.	800T-N179
 Cat. No. 800T-N12	Bul. 800T Rocker Arm Operating Lever The rocker arm lever operates two flush head or one flush with one extended head momentary contact push button units spaced 1-27/32 in. (46.8 mm) center-to-center. Legend plates must be ordered separately and should be inverted 180° prior to engraving and installation.	800T-N12

Miscellaneous

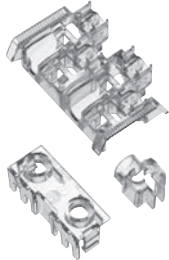



	Description	Cat. No.
 Cat. No. 800T-N245	Bul. 800T/H Mounting Ring Wrench This wrench will simplify tightening or loosening the octagonal mounting ring used on Bul. 800T units. This wrench is double-ended and can be used for 18 mm and 30 mm pilot light mounting rings.	800T-N245
 Cat. No. 800T-N209RE1	Bul. 800T/H Jumbo Push-Pull Cap For use on Bul. 800T or 800H push-pull operators. Fits on illuminated and non-illuminated devices.	800T-N209RE1
	Bul. 800T 63 mm Red Anodized Aluminum Cap For use on Bul. 800T non-illuminated push-pull devices.	800T-N210R
	Bul. 800T 63 mm Red Anodized Aluminum Cap with "E-Stop" For use on Bul. 800T non-illuminated push-pull devices.	800T-N210RE
	Bul. 800T 90 mm Gold Anodized Aluminum Cap For use on Bul. 800T non-illuminated push-pull devices.	800T-N211GL
 Cat. No. 800T-N300	Bul. 800T Bonding Bracket The bonding bracket establishes an electrical circuit between the mounting surface and metal operator bushing for grounding purposes; recommended for installations which require CSA approval. Necessary mounting hardware is included. Order Cat. No. 800T-N300 for back-of-panel bracket. Order Cat. No. 800T-N300F for front-of-panel bracket.	800T-N300
		800T-N300F
 Cat. No. 800E-ALR1	Bul. 800T/H Lens/Bulb Removal Tool The small end of this tool provides quick and easy removal of any incandescent or LED lamp.	800F-ALR1

Miscellaneous, Continued







		Description	Cat. No.	
 Cat. No. 800T-N324 Cat. No. 800T-N323 IEC Finger-Safe Accessories	Cat. No. 800T-N323	Bul. 800T/H IEC Finger-Safe Terminal Guards Snap-on accessories which provide IEC, IP2X and VGB finger-safe protection. Single terminal guards for single circuit contact blocks, full voltage modules, LED modules, etc. (800T-XD1, -XD2, -XD3, -XD4, -XD5, -XD6, -XAP, -XD1P, -XD2P, -PC..., and -QC...)* Note: Must be ordered in multiples of 100 pieces.	800T-N322	
	Cat. No. 800T-N322	Transformer covers for transformer only. Note: Must be ordered in multiples of 25 pieces.	800T-N324	
		Multi-terminal side cover for use on single or double circuit contact blocks. (800T-XA, -XA1, -XA2, -XA4, -XA7, -XAR, -XA2R, -XA4R, -XD1R, and -XD2R) Note: Must be ordered in multiples of 25 pieces.	800T-N323	
 Cat. No. 800T-N292		Grey Bul. 800T Trim Washer Used to mount the operator properly when a legend plate is not being used. Note: Must be ordered in multiples of 10 pieces.	800T-N292	
		Plastic Bul. 800H Trim Washer Used to mount the operator properly when a legend plate is not being used. Note: Must be ordered in multiples of 10 pieces.	800H-N148	
 Cat. No. 800T-N293		Metal Bul. 800T Thrust Washer Used to prevent rotation of operators in a keyed or notched hole. Note: Must be ordered in multiples of 10 pieces.	800T-N293	
		Plastic Bul. 800H Thrust Washer Used to prevent rotation of operators in a keyed or notched hole. Note: Must be ordered in multiples of 10 pieces.	800H-N146	
 Cat. No. 800T-N188		Bul. 800T Etching Fluid Used to blacken freshly engraved aluminum legend plates.	800T-N188	
		Description	Color	Cat. No.
 Cat. No. 800T-N1		Bul. 800T/H Closing Button Where an enclosure or flush plate with more than the required number of openings is used, this neat-appearing button can be supplied to close the unused openings.	Grey	800T-N1
			Black	800T-N1B

* Power modules excluding transformers and dual inputs

Locking Attachments









	Description	Cat. No.
 <p>Cat. No. 800T-N2 (Padlock not included)</p>	<p>Bul. 800T Extended Head Push Button Padlocking Attachments Permits locking in the depressed position. Locks the normally closed contact in the open position. For extended head non-illuminated momentary push buttons.</p>	<p>800T-N2</p>
 <p>Cat. No. 800T-N10 (Padlock not included)</p>	<p>Bul. 800T Flush Head Push Button Padlocking Attachments Permits locking in the depressed position. Locks the normally closed contact in the open position. For flush head push button.</p>	<p>800T-N10</p>
 <p>Cat. No. 800T-N315 (Padlock not included)</p>	<p>Bul. 800T Momentary Mushroom Padlocking Attachments For Bul. 800T non-illuminated momentary mushroom push button. Requires use of Cat. No. 800T-N311 mushroom cap. This device is used to lock the mushroom button in a depressed position.</p>	<p>800T-N315</p>
 <p>Cat. No. 800T-N314 (Padlock not included)</p>	<p>Bul. 800T/H Push-Pull Padlocking Attachment For 2-position push-pull and push-pull/twist release illuminated and non-illuminated operators. Use on standard head only (40 mm dia.). Locks the normally closed contacts open only. Conversion of normally closed late break contacts to standard normally closed contacts are recommended when using this accessory. Made of stainless steel.</p>	<p>800T-N314</p>
 <p>Cat. No. 800T-N163 (Padlock not included)</p>	<p>Bul. 800T/H Padlocking Cover Guards against unauthorized operation for non-illuminated, standard knob selector switches and potentiometers. Stainless steel and clear plastic construction.</p>	<p>800T-N163</p>
	<p>Bul. 800T/H Trigger Action Padlocking Attachment For 2-position trigger action E-stops with 45 mm heads.</p>	<p>800T-N378</p>

Locking Attachments, Continued

	Description		Cat. No.																										
 Cat. No. 800H-N140 (Padlock not included)	Bul. 800T/H Padlocking Cover Guards against unauthorized operation. For non-illuminated push buttons, 2-position push-pull or twist-release units, and standard knob selector switches. When applying Cat. No. 800H-N140 on 2-position maintained push-pull units, cover will lock only when the button is in depressed position. Padlocking cover includes blank legend plate for customer marking. Note: A pre-marked legend plate is available. The words OPEN COVER TO OPERATE are on the front and PULL-TO-START-PUSH-TO-STOP are on the rear. To order legend plate only, specify Cat. No. 800H-W174L.		800H-N140																										
 Cat. No. 800T-NX446 (Padlock not included)	Bul. 800T 2- and 3-Position Non-illuminated Selector Switch Padlocking Attachment — Standard Knob Padlocking guard for 2- and 3-position selector switches with standard knob operators only. Locks selector switch in any maintained position.*		800T-NX446																										
 Cat. No. 800H-N141R (Padlock not included)	<table border="1"> <thead> <tr> <th data-bbox="532 699 1065 726">Description</th> <th data-bbox="1065 699 1333 726">Position</th> <th data-bbox="1333 699 1481 726">Cat. No.</th> </tr> </thead> <tbody> <tr> <td data-bbox="532 726 1065 789" rowspan="4"> Bul. 800H 2- and 3-Position Selector Switch with Padlocking Guards Padlocking guard for 2- and 3-position selector switches with standard knob operators only. </td> <td data-bbox="1065 726 1333 758">Left</td> <td data-bbox="1333 726 1481 758">800H-N141L</td> </tr> <tr> <td data-bbox="1065 758 1333 789">Center</td> <td data-bbox="1333 758 1481 789">800H-N141C</td> </tr> <tr> <td data-bbox="1065 789 1333 905">Right</td> <td data-bbox="1333 789 1481 905">800H-N141R</td> </tr> <tr> <td data-bbox="1065 905 1333 947">All</td> <td data-bbox="1333 905 1481 947">800H-N141A</td> </tr> </tbody> </table>	Description	Position	Cat. No.	Bul. 800H 2- and 3-Position Selector Switch with Padlocking Guards Padlocking guard for 2- and 3-position selector switches with standard knob operators only.	Left	800H-N141L	Center	800H-N141C	Right	800H-N141R	All	800H-N141A																
Description	Position	Cat. No.																											
Bul. 800H 2- and 3-Position Selector Switch with Padlocking Guards Padlocking guard for 2- and 3-position selector switches with standard knob operators only.	Left	800H-N141L																											
	Center	800H-N141C																											
	Right	800H-N141R																											
	All	800H-N141A																											
 Cat. No. 800T-NX446A (Padlock not included)	Bul. 800T 4-Position Selector Switch Attachment — Standard Knob Kit includes selector switch and guard (padlock not included). Padlocking guard for 4-position selector switches with standard knob operators only. Locks selector switch in any maintained position.*		800T-NX446A																										
 Cat. No. 800H-N316J (Padlock not included)	<table border="1"> <thead> <tr> <th data-bbox="532 1171 1065 1199">Description</th> <th data-bbox="1065 1171 1333 1199">Position</th> <th data-bbox="1333 1171 1481 1199">Cat. No.</th> </tr> </thead> <tbody> <tr> <td data-bbox="532 1199 1065 1423" rowspan="10"> Bul. 800T/H Non-Illuminated Selector Switch Padlocking Attachment 2-, 3-, and 4-position selector switch padlocking attachments. Can be used to lock operators in a desired position. For 3-position selector switches, this device can also be used to lock out a left or right position as shown in the photo to the left. </td> <td colspan="2" data-bbox="1065 1199 1333 1230">For 2- and 3-Position Selector Switches</td> </tr> <tr> <td data-bbox="1065 1230 1333 1262">Left</td> <td data-bbox="1333 1230 1481 1262">800T-N316L</td> </tr> <tr> <td data-bbox="1065 1262 1333 1293">Center</td> <td data-bbox="1333 1262 1481 1293">800T-N316C</td> </tr> <tr> <td data-bbox="1065 1293 1333 1325">Right</td> <td data-bbox="1333 1293 1481 1325">800T-N316R</td> </tr> <tr> <td data-bbox="1065 1325 1333 1356">Window Center through Right - Prevent Left Operation</td> <td data-bbox="1333 1325 1481 1356">800T-N316J</td> </tr> <tr> <td data-bbox="1065 1356 1333 1388">Window Center through Left - Prevent Right Operation</td> <td data-bbox="1333 1356 1481 1388">800T-N316K</td> </tr> <tr> <td colspan="2" data-bbox="1065 1388 1333 1419">For 4-Position Selector Switches</td> </tr> <tr> <td data-bbox="1065 1419 1333 1451">Left (Pos. 1)</td> <td data-bbox="1333 1419 1481 1451">800T-N317L</td> </tr> <tr> <td data-bbox="1065 1451 1333 1482">Center Left (Pos. 2)</td> <td data-bbox="1333 1451 1481 1482">800T-N317CL</td> </tr> <tr> <td data-bbox="1065 1482 1333 1514">Center Right (Pos. 3)</td> <td data-bbox="1333 1482 1481 1514">800T-N317CR</td> </tr> <tr> <td data-bbox="1065 1514 1333 1545">Right (Pos. 4)</td> <td data-bbox="1333 1514 1481 1545">800T-N317R</td> </tr> </tbody> </table>	Description	Position	Cat. No.	Bul. 800T/H Non-Illuminated Selector Switch Padlocking Attachment 2-, 3-, and 4-position selector switch padlocking attachments. Can be used to lock operators in a desired position. For 3-position selector switches, this device can also be used to lock out a left or right position as shown in the photo to the left.	For 2- and 3-Position Selector Switches		Left	800T-N316L	Center	800T-N316C	Right	800T-N316R	Window Center through Right - Prevent Left Operation	800T-N316J	Window Center through Left - Prevent Right Operation	800T-N316K	For 4-Position Selector Switches		Left (Pos. 1)	800T-N317L	Center Left (Pos. 2)	800T-N317CL	Center Right (Pos. 3)	800T-N317CR	Right (Pos. 4)	800T-N317R		
Description	Position	Cat. No.																											
Bul. 800T/H Non-Illuminated Selector Switch Padlocking Attachment 2-, 3-, and 4-position selector switch padlocking attachments. Can be used to lock operators in a desired position. For 3-position selector switches, this device can also be used to lock out a left or right position as shown in the photo to the left.	For 2- and 3-Position Selector Switches																												
	Left	800T-N316L																											
	Center	800T-N316C																											
	Right	800T-N316R																											
	Window Center through Right - Prevent Left Operation	800T-N316J																											
	Window Center through Left - Prevent Right Operation	800T-N316K																											
	For 4-Position Selector Switches																												
	Left (Pos. 1)	800T-N317L																											
	Center Left (Pos. 2)	800T-N317CL																											
	Center Right (Pos. 3)	800T-N317CR																											
Right (Pos. 4)	800T-N317R																												
 Cat. No. 800H-N4162L (Padlock not included)	<table border="1"> <thead> <tr> <th data-bbox="532 1570 1333 1598">Description</th> <th data-bbox="1065 1570 1333 1598">Position</th> <th data-bbox="1333 1570 1481 1598">Cat. No.</th> </tr> </thead> <tbody> <tr> <td data-bbox="532 1598 1333 1875" rowspan="10"> Bul. 800T/H Illuminated Selector Switch Padlocking Attachment 2- and 3-position selector switch padlocking attachments for illuminated selector switches. Stainless steel material </td> <td colspan="2" data-bbox="1065 1598 1333 1629">For 2-Position Selector Switches</td> </tr> <tr> <td data-bbox="1065 1629 1333 1661">Left</td> <td data-bbox="1333 1629 1481 1661">800T-N4162L</td> </tr> <tr> <td data-bbox="1065 1661 1333 1692">Right</td> <td data-bbox="1333 1661 1481 1692">800T-N4162R</td> </tr> <tr> <td colspan="2" data-bbox="1065 1692 1333 1724">For 3-Position Selector Switches</td> </tr> <tr> <td data-bbox="1065 1724 1333 1755">Left</td> <td data-bbox="1333 1724 1481 1755">800T-N4163L</td> </tr> <tr> <td data-bbox="1065 1755 1333 1787">Center</td> <td data-bbox="1333 1755 1481 1787">800T-N4163C</td> </tr> <tr> <td data-bbox="1065 1787 1333 1818">Right</td> <td data-bbox="1333 1787 1481 1818">800T-N4163R</td> </tr> <tr> <td data-bbox="1065 1818 1333 1850">Window Center through Right - Prevent Left Operation</td> <td data-bbox="1333 1818 1481 1850">800T-N4163J</td> </tr> <tr> <td data-bbox="1065 1850 1333 1875">Window Center through Left - Prevent Right Operation</td> <td data-bbox="1333 1850 1481 1875">800T-N4163K</td> </tr> </tbody> </table>		Description	Position	Cat. No.	Bul. 800T/H Illuminated Selector Switch Padlocking Attachment 2- and 3-position selector switch padlocking attachments for illuminated selector switches. Stainless steel material	For 2-Position Selector Switches		Left	800T-N4162L	Right	800T-N4162R	For 3-Position Selector Switches		Left	800T-N4163L	Center	800T-N4163C	Right	800T-N4163R	Window Center through Right - Prevent Left Operation	800T-N4163J	Window Center through Left - Prevent Right Operation	800T-N4163K					
Description	Position	Cat. No.																											
Bul. 800T/H Illuminated Selector Switch Padlocking Attachment 2- and 3-position selector switch padlocking attachments for illuminated selector switches. Stainless steel material	For 2-Position Selector Switches																												
	Left	800T-N4162L																											
	Right	800T-N4162R																											
	For 3-Position Selector Switches																												
	Left	800T-N4163L																											
	Center	800T-N4163C																											
	Right	800T-N4163R																											
	Window Center through Right - Prevent Left Operation	800T-N4163J																											
	Window Center through Left - Prevent Right Operation	800T-N4163K																											



* Diameter of hasp is 11/32 in. (8.73 mm)

Guards

	Description	Type	Cat. No.
 Cat. No. 800T-N13	Bul. 800T Push Button Guards Momentary push button guards to reduce the risk of accidental operation.	1 in. guard for non-illuminated	800T-N13
		1/2 in. guard for non-illuminated	800T-N143
		1-1/2 in. guard for illuminated	800T-N93
		1-1/2 in. guard for non-illuminated with locking attachment	800T-N39
 Cat. No. 800H-N152	Bul. 800H Illuminated Push Button Guard This guard provides additional protection against accidental operation of the push button unit. 1-1/2 in. (38.1 mm) guard for illumination units.		800H-N152
 Cat. No. 800T-N226	Bul. 800T 18 mm Guard Provides side protection for 18 mm pilot lights.		800T-N226
 Cat. No. 800H-N153	Bul. 800H Stainless Steel Guard Used on non-illuminated push buttons that have protective boots as shown on page 10-39.		800H-N153
 Cat. No. 800T-N129	Bul. 800T Mushroom Push Button Guards Momentary mushroom guards for standard and jumbo mushroom push buttons. Reduces the risk of accidental operation.	Standard guard	800T-N129
		Standard guard with set screw	800T-N165
		Jumbo guard	800T-N151
		Jumbo guard with set screw	800T-N154
 Cat. Nos. 800T-N310 and 800T-NX1320	Bul. 800T/H Protective Guard Protective ring for Bul. 800T 2-position push-pull operators. Illuminated or non-illuminated. Often used to avoid unintentional tripping of E-stop operators. This guard is used with standard size button (40 mm dia.).	Stainless steel	800T-N310
		Black	800T-NX1320
 Cat. No. 800T-N310J	Bul. 800T/H Jumbo Protective Guard Protective ring for Bul. 800T 2-position push-pull operators. Illuminated or non-illuminated. Often used to avoid unintentional tripping of E-stop operators.	60 mm (Jumbo)	800T-N310J
		63 mm	800T-N310L
		45 mm	800T-N381
 Cat. No. 800T-N381	Bul. 800T/H Protective Guard Protective ring for Bul. 800T trigger action E-stop operators.	60/63 mm	800T-N381L
 Cat. No. 800T-N339	Bul. 800T/H Ramp Guard For Bul. 800T/800H 2- and 3-position illuminated and non-illuminated push-pull units. Standard size button only (40 mm dia.).		800T-N339

Replacement Lamps

Pilot Lights, Illuminated Push Buttons, Illuminated Push-Pull, Illuminated Push-Pull/Twist to Release, and Illuminated Selector Switches

Lamp	Type	Current, Typical	Lamp Voltage	ANSI No.	Catalog Voltage Code	Cat. No.
	Full Voltage Transformer	150 mA/250 mA	6.3V AC	755/1866	6, 16, 26, 36, 46, 56, 76	* 800T-N65
	Full Voltage	80 mA	14V AC/DC	756	12	* 800T-N141
		70 mA	24V AC/DC	757	24	* 800T-N157
		50 mA	48V AC/DC	1835	48	* 800T-N365
	Full Voltage Resistor	22 mA	120V AC/DC	949	10, 11	* 800T-N169
	Flashing	150 mA	6V AC/DC	267	6	* 800T-N212
		57 mA	24V AC/DC	24 MB	24	* 800T-N180
Dual Input Diode	21 mA	120V AC	90 MB	16	* 800T-N261	
Neon 	—	2 mA	120V AC/DC	B2A	10, 20	609-N9
Lamp	Type	Current, Typical*	Lamp Voltage	Leakage Current	Code	Cat. No.*
	Universal	13 mA @ 24V DC 8.5 mA @ 120V AC†	3V‡	3 mA	2	800T-N376x
	Transformer	60	6V	14 mA	16, 26, 46, 56	800T-N377x



- * Item is sold in multiples of 5. Order quantity of 5 to receive package of 5 pieces.
- * To complete the cat. no. replace the **x** with the first letter of the desired color: **Green**, **Red**, or **White**.
- † Typical current consumption values indicated are relative to the input of the power module.
- ‡ Lamp is intended for use with power module Cat. No. 800TC-N374 which has an input voltage rating of 12 ...130V AC/DC.

Legacy LED Lamps*

Lamp	Type	Current, Typical>	Lamp Voltage	Leakage Current	Catalog Voltage Code	Cat. No.*
	Full Voltage	13 mA/22 mA	12V AC/DC	3 mA	12	800T-N362x
		20 mA/21 mA	24V AC/DC	3 mA	24	800T-N319x
		12 mA/17 mA	32V AC/DC	3 mA	32	800T-N363x
		9 mA/14 mA	48V AC/DC	3 mA	48	800T-N364x
		3.3 mA/6 mA	120V AC	—	10	800T-N320x
		4.5 mA/6.2 mA	130V AC/DC	3 mA	13	800T-N321x
	Transformer	50 mA	6V AC	14 mA	6, 16, 26, 36, 46, 56, 76	800T-N318x
Flashing	18 mA	24V AC/DC	—	N/A	+ 800T-N319Fx	

- * In full voltage applications, these lamps are intended to be used with power module Cat. No. 800T-N330.
- ❖ All LEDs except 120V have an internal shunt resistor for use with solid-state outputs. LEDs will not illuminate below listed leakage current.
- > Typical current draw varies with LED color. The first mA value is for a green or blue LED and the second mA value is for a red or amber LED.
- * To complete the cat. no. replace the **x** with the first letter of the desired color: **Amber**, **Green**, **Red**, **Blue**, or **White**. White LEDs only available in 6V, 24V, 120V, and 130V.
- + Flashing rate is 2 Hz.

Cluster Pilot Lights

Lamp	Type	Current, Typical	Lamp Voltage	ANSI No.	Cat. No.*
	Full Voltage Transformer	195 mA	6V AC/DC	381	800T-N258
	Full Voltage	73 mA	12V AC/DC	382	800T-N259
		37 mA	24V AC/DC	387	800T-N260
Lamp	Type	Current, Typical	Lamp Voltage	Polarity	Cat. No.*
	Full Voltage Transformer	45 mA	6V AC/DC	Positive	800T-N340x
	Full Voltage	36 mA	12V AC/DC	Positive	800T-N341x
		14 mA	28V AC/DC	Bi-Polar	11 800T-N80x

- * Item is sold in multiples of 5. Order quantity of 5 to receive package of 5 pieces.
- * To complete the cat. no., replace the **x** with the first letter of the desired color: **Amber**, **Green**, or **Red** only.
- 11 For use with 24V AC/DC rated devices.

Replacement Keys for Cylinder Lock 2-, 3-, and 4-Position Selector Switches (800T only)

Cylinder Lock Key Option Code	Series Key Number	Cat. No.	Cylinder Lock Key Option Code	Series Key Number	Cat. No.
Blank (standard key)	D018 (standard key)	X-181170	15	T112*	40269-087-01
03	D020*	X-307922	16	T115*	40269-087-02
04	D025*	X-307923	17	T324*	40269-087-03
05	D335*	X-307924	18	T382*	40269-087-04
06	D429*	X-307925	19	T404*	40269-087-05
07	D461*	X-307926	20	T171*	40269-087-06
08	D111*	X-307927	21	T484*	40269-087-07
09	D587*	X-307928	22	T547*	40269-087-08
10	D682*	X-307929	23	T569*	40269-087-09
11	D713*	X-307930	24	T692*	40269-087-10
12	D900*	X-307931	25	T752*	40269-087-11
13	D992*	X-307932	26	T178*	40269-087-12
14	D118*	X-307933			

* Uses master key DM81, AB Cat. No. X-433358.

* Uses master key 15T, AB Cat. No. X-433359.

Replacement Keys for Push Button Switches with Cylinder Locks (800T only)

Lock Key Option Code			Series Key Number	Cat. No.
Spring Bolt	Dead Bolt A	Dead Bolt B		
Blank (standard key)	Blank (standard key)	Blank (standard key)	E158 (standard key)	X-144218
44	32	20	E109	X-386233
45	33	21	E131	X-386234
46	34	22	E100	X-386235
47	35	23	E115	X-386236
48	36	24	E120	X-386237
49	37	25	E104	X-386238
50	38	26	E108	X-386239
51	39	27	E132	X-386240
52	40	28	E144	X-386241
53	41	29	E157	X-386242
54	42	30	E101	X-386243
55	43	31	E102	40274-250-01
66	61	56	E106	40274-250-07
67	62	57	E111	40274-250-02
68	63	58	E117	40274-250-14
69	64	59	E125	40274-250-21
70	65	60	E130	40274-250-26



Blank and Custom Legend Plates — Aluminum, Type 4/13 (800T)

Blank/Custom Legend Plates

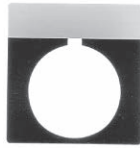

Standard Legend Plate



Jumbo Legend Plate

Legend Plate Color	Standard	Jumbo
	Cat. No.	Cat. No.
Grey	800T-X559	800T-X559J
Red	800T-X621	800T-X621J
Yellow	800T-X679	800T-X679J
Grey (with custom text)	800T-X559E	800T-X559JE
Red (with custom text)	800T-X621E	800T-X621JE
Yellow (with custom text)	800T-X679E	800T-X679JE

Specialty Legend Plates



Automotive Legend Plate



Half Round Legend Plate

Legend Plate Color	Automotive	Half Round*
	Cat. No.	Cat. No.
Grey (blank)	800T-X700	800T-X59
Red (blank)	800T-X701	800T-X121
Grey (with custom text)	800T-X700E	800T-X59E
Red (with custom text)	800T-X701E	800T-X121E

Note: Include text with custom legends.

* All half round legend plates must be ordered in quantities of 25.

Custom Text Guidelines

Legend Size	No. of Lines	Max. No. of Characters per Line
Standard	1 line of	14
	2 lines of	14
Jumbo	5 lines	14
Automotive	4 lines	20

Custom Legend Plates for 4-Way Toggle and Cluster Pilot Lights

Legend Size	Cat. No.‡	Color	Text Options*
Standard	800T-X619E	Aluminum (with custom text)	2 lines of up to 14 characters on top 1 line of up to 14 characters on bottom
			1 vertical line of up to 7 characters on left side 1 vertical line of up to 7 characters on right side
			1 vertical line of up to 9 characters on left side 1 vertical line of up to 9 characters on right side

* Rule sets listed are mutually exclusive; only one can be chosen.

‡ For blank toggle or cluster pilot legend, order Cat. No. 800T-X619.

Blank and Custom Legend Plates — Aluminum, Type 4/13 (800T), Continued
 Specialty Legend Plates



Cat. No. **800T-X618**



Cat. No. **800T-X647Y**



Cat. No. **800T-X646**

Type	Start/Stop Legend Plates		Emergency Stop Legend Plates	
	Grey	Yellow	Yellow (Large Size)	Yellow IEC Ring
	Cat. No.	Cat. No.	Cat. No.	Cat. No.
Push-to-Stop Pull-to-Start or Push-to-Stop Twist or Pull Release	800T-X618	800T-X618Y	800T-X647Y	—
Blank	—	—	800T-X645Y	800T-X646
Custom	—	—	800T-X645YE	—
Emergency Stop	—	—	—	800T-X646EM

Potentiometer Legend Plates



Cat. No. **800T-X609**



Cat. No. **800T-X608**

Type	Cat. No.
Potentiometer with graduated markings	800T-X609
SPEED	800T-X608

* For graduated markings with a custom text, order Cat. No. 800T-X609E and specify up to two lines of text, 14 characters per line.

18 mm Legend Plates



Type A Legend Plate
 Cat. No. **800T-N515**

Description	Cat. No.
Blank	
Type A	800T-N515
Type B	800T-N516
With Custom Marking*	
Type A with Text	800T-N515E
Type B with Text	800T-N516E

* Text must be supplied.

Custom Text Guidelines

Legend Type	Number of Lines	Maximum Number of Characters per Line
A	1	9
B	2	13

Standard Legend Plates – Aluminum, Type 4/13 (Bul. 800T)



Standard Legend Plate



Jumbo Legend Plate

Marking	Standard	Jumbo	Marking	Standard	Jumbo
	Cat. No.	Cat. No.		Cat. No.	Cat. No.
AUTO-OFF-HAND	800T-X501	800T-X501J	ON-OFF	800T-X622	800T-X622J
AUTO-MAN-OFF	800T-X625	800T-X625J	OPEN	800T-X531	800T-X531J
CLOSE	800T-X502	800T-X502J	OPEN-CLOSE	800T-X532	800T-X532J
CYCLE START	800T-X562	800T-X562J	OPEN-OFF-CLOSE	800T-X533	800T-X533J
DOWN	800T-X503	800T-X503J	OUT	800T-X534	800T-X534J
EMERG. STOP (Yellow)	800T-X504Y	—	POWER ON	800T-X639	800T-X639J
EMERG. STOP (Red)*	800T-X504	800T-X504J	RAISE	800T-X535	800T-X535J
EMERGENCY STOP (Red)*	800T-X648	800T-X648J	RAISE-LOWER	800T-X536	800T-X536J
FAST	800T-X505	800T-X505J	RAISE-OFF-LOWER	800T-X537	800T-X537J
FEED START	800T-X566	800T-X566J	RESET	800T-X538	800T-X538J
FEED STOP	800T-X567	800T-X567J	REVERSE	800T-X539	800T-X539J
FOR.-REV.	800T-X506	800T-X506J	RUN	800T-X540	800T-X540J
FOR.-OFF-REV.	800T-X507	800T-X507J	RUN-INCH	800T-X634	800T-X634J
FORWARD	800T-X508	800T-X508J	RUN-JOG	800T-X541	800T-X541
FOURTH SPEED	800T-X624	800T-X624J	SAFE-RUN	800T-X542	800T-X542J
FULL SPEED	800T-X509	800T-X509J	SECOND SPEED	800T-X543	800T-X543J
HAND-AUTO	800T-X510	800T-X510J	SPEED*	800T-X608	—
HAND-OFF-AUTO	800T-X511	800T-X511J	SLOW	800T-X544	800T-X544J
HIGH	800T-X512	800T-X512J	SLOW-FAST	800T-X545	800T-X545J
HIGH-LOW	800T-X513	800T-X513J	SLOW-OFF-FAST	800T-X546	800T-X546J
HIGH-OFF-LOW	800T-X514	800T-X514J	START	800T-X547	800T-X547J
IN	800T-X515	800T-X515J	START-JOG	800T-X548	800T-X548J
INCH	800T-X516	800T-X516J	START-STOP	800T-X549	800T-X549J
JOG	800T-X517	800T-X517J	STOP (Red)	800T-X550	800T-X550J
JOG FORWARD	800T-X518	800T-X518J	STOP-START	800T-X551	800T-X551J
JOG REVERSE	800T-X519	800T-X519J	SUMMER-OFF-WINTER	800T-X553	800T-X553J
JOG RUN	800T-X520	800T-X520J	SUMMER-WINTER	800T-X552	800T-X552J
JOG-SAFE-RUN	800T-X522	800T-X522J	TEST	800T-X554	800T-X554J
JOG-STOP-RUN	800T-X521	800T-X521J	THIRD SPEED	800T-X555	800T-X555J
LEFT-RIGHT	800T-X523	800T-X523J	UP	800T-X556	800T-X556J
LOCAL-REMOTE	800T-X638	800T-X638J	UP-DOWN	800T-X557	800T-X557J
LOW	800T-X524	800T-X524J	UP-OFF-DOWN	800T-X558	800T-X558J
LOW SPEED	800T-X525	800T-X525J	O (Red)	800T-X640	800T-X640J
LOWER	800T-X526	800T-X526J	I	800T-X641	800T-X641J
OFF	800T-X527	800T-X527J	O I	800T-X642	800T-X642J
OFF-COOLANT-ON	800T-X528	800T-X528J	I O II	800T-X643	800T-X643J
OFF-ON	800T-X529	800T-X529J	—	—	—
ON	800T-X530	800T-X530J	—	—	—

* These legend plates do not comply with E-Stop standards that specify a yellow background, such as IEC 60947-5-5 and NFPA 79.

* Potentiometer type with graduated markings.

Legend Plates – Plastic, Type 4/4X/13 (800H)



Standard Legend Plate
 Cat. No. 800H-W100



Jumbo Legend Plate
 Cat. No. 800H-W100J



Automotive Legend Plate
 Cat. No. 800H-W100A

Blank/Custom Legend Plates Type 4/4X

Legend Plate Color	Standard	Jumbo	Automotive
	Cat. No.	Cat. No.	Cat. No.
Grey (Blank)	800H-W100	800H-W100J	800H-W100A
Red (Blank)	800H-W300	800H-W300J	800H-W300A
White (Blank)	800H-W500	800H-W500J	800H-W500A
Yellow (Blank)	800H-W700	800H-W700J	800H-W700A
Grey (with Custom Text)	800H-W100E	800H-W100JE	800H-W100AE
Red (with Custom Text)	800H-W300E	800H-W300JE	800H-W300AE
White (with Custom Text)	800H-W500E	800H-W500JE	800H-W500AE
Yellow (with Custom Text)	800H-W700E	800H-W700JE	800H-W700AE

Note: Include text with custom legends.

Custom Text Guidelines

Legend Size	Number of Lines	Maximum Number of Characters per Line
Standard	1 Line of	13
	2 Lines of	13
Jumbo	5 Lines	13
Automotive	4 Lines	16



Potentiometer Legend Plate
 Cat. No. 800H-W080

Potentiometer Legends

Legend Marking	Cat. No.
Graduated Markings Only	800H-W080
SPEED	800H-W081
Custom Legend with Graduated Marking	800H-W080E



Cat. No. **800H-W196**



Cat. No. **800H-W797A**



Cat. No. **800H-W690**

Type	Start/Stop Legend Plates	Emergency Stop Legend Plates	
	Grey Cat. No.	Yellow (Large Size) Cat. No.	Yellow IEC Ring Cat. No.
Push-to-Stop Pull-to-Start	800H-W196	800H-W797A	—
Blank	—	800H-W700A	800H-W690
Custom	800H-W100E	800H-W700AE	—

Standard Legend Plates – Plastic, Type 4/4X/13 (800H)

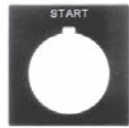

Grey Legend Plate
Type 4/4X



White Legend Plate
Type 4/4X

Marking	Grey Type 4/4X	White Type 4/4X	Marking	Grey Type 4/4X	White Type 4/4X
	Cat. No.	Cat. No.		Cat. No.	Cat. No.
AUTO OFF HAND	800H-W154	800H-W554	LOWER	800H-W115	800H-W515
AUTO MAN OFF	800H-W059	800H-W459	MAN AUTO	800H-W031	800H-W431
CLOSE	800H-W101	800H-W501	MAN OFF AUTO	800H-W062	800H-W462
CYCLE START	800H-W006	800H-W406	MOTOR RUN	800H-W008	800H-W408
CYCLE STOP (Red)	800H-W376	—	MOTOR STOP (Red)	800H-W375	—
DECREASE	800H-W002	800H-W402	OFF	800H-W116	800H-W516
DOWN	800H-W102	800H-W502	OFF COOLANT ON	800H-W052	800H-W452
EMERG. STOP (Red)*	800H-W372	—	OFF LOC REMOTE	800H-W061	—
EMERGENCY STOP (Red)*	800H-W373	—	OFF MAN AUTO	800H-W060	800H-W460
FAST	800H-W104	800H-W504	OFF ON	800H-W133	800H-W533
FEED START	800H-W007	—	ON	800H-W117	800H-W517
FEED STOP (Red)	800H-W377	—	OPEN	800H-W118	800H-W518
FOR. REV.	800H-W132	800H-W532	OPEN CLOSE	800H-W134	800H-W534
FOR. OFF REV.	800H-W152	800H-W552	OPEN OFF CLOSE	800H-W153	800H-W553
FORWARD	800H-W105	800H-W505	OUT	800H-W119	800H-W519
FOURTH SPEED	800H-W010	—	POWER ON	800H-W001	800H-W401
FULL SPEED	800H-W106	800H-W506	PULL-TO-START	800H-W198	—
HAND AUTO	800H-W131	800H-W531	PUSH-TO-STOP (Red)	800H-W378	—
HAND OFF AUTO	800H-W151	800H-W551	RAISE	800H-W120	800H-W520
HIGH	800H-W107	800H-W507	RAISE LOWER	800H-W034	—
HIGH LOW	800H-W030	—	RAISE OFF LOWER	800H-W156	800H-W556
HIGH LOW OFF	800H-W058	—	RESET	800H-W121	800H-W521
HIGH OFF LOW	800H-W155	800H-W555	REVERSE	800H-W122	800H-W522
IN	800H-W108	800H-W508	RIGHT	800H-W005	800H-W405
INCH	800H-W109	800H-W509	RUN	800H-W123	800H-W523
INCREASE	800H-W003	—	RUN INCH	800H-W037	—
JOG	800H-W110	800H-W510	RUN JOG	800H-W032	—
JOG FORWARD	800H-W111	800H-W511	SAFE RUN	800H-W033	—
JOG REVERSE	800H-W112	800H-W512	SECOND SPEED	800H-W124	800H-W524
JOG RUN	800H-W135	800H-W535	SLOW	800H-W125	800H-W525
JOG SAFE RUN	800H-W051	—	SLOW FAST	800H-W136	800H-W536
JOG STOP RUN	800H-W057	—	SLOW OFF FAST	800H-W157	800H-W557
LEFT	800H-W004	800H-W404	SPEED*	800H-W081	800H-W481
LEFT RIGHT	800H-W036	—	SPEED*	800H-W182	—
LOC OFF REMOTE	800H-W055	800H-W455	START	800H-W126	800H-W526
LOW	800H-W113	800H-W513	START JOG	800H-W138	800H-W538
LOW HIGH	800H-W035	—	START JOG STOP	800H-W158	800H-W558
LOW OFF HIGH	800H-W056	—	START RUN STOP	800H-W054	—
LOW SPEED	800H-W114	800H-W514	START STOP	800H-W137	800H-W537

* These legend plates do not comply with E-Stop standards that specify a yellow background, such as IEC 60947-5-5 and NFPA 79.

* Potentiometer type with graduated markings.

Standard Legend Plates – Plastic, Type 4/4X/13 (800H)



Grey Legend Plate
Type 4/4X



White Legend Plate
Type 4/4X

Marking	Grey Type 4/4X	White Type 4/4X	Marking	Grey Type 4/4X	White Type 4/4X
	Cat. No.	Cat. No.		Cat. No.	Cat. No.
UP	800H-W009	800H-W409	STOP (Red)	800H-W371	—
UP DOWN	800H-W039	—	STOP RUN START	800H-W053	—
UP OFF DOWN	800H-W160	800H-W560	STOP START	800H-W038	800H-W438
O (Red)	800H-W184	—	SUMMER OFF WINTER	800H-W159	800H-W559
O I	800H-W185	800H-W582	SUMMER WINTER	800H-W139	800H-W539
I	800H-W181	800H-W581	TEST	800H-W128	800H-W528
I O II	800H-W183	800H-W583	THIRD SPEED	800H-W129	800H-W529

Flip Lever Legend Plates (for use with Series D operators)

Marking	Grey — Type 4/4X	Marking	Grey — Type 4/4X	Marking	Grey — Type 4/4X
	Cat. No.		Cat. No.		Cat. No.
Blank	800H-W200	LOW	800H-W213	RUN	800H-W223
Customer-Specified*	800H-W200E	BAS	800H-W213F	EN MARCHE	800H-W223F
CLOSE	800H-W201	LOW SPEED	800H-W214	SECOND SPEED	800H-W224
FERMER	800H-W201F	VITESSE MIN	800H-W214F	VITESSE 2	800H-W224F
DOWN	800H-W202	LOWER	800H-W215	SLOW	800H-W225
DESCENDRE	800H-W202F	ABAISSER	800H-W215F	LENT	800H-W225F
FAST	800H-W204	OFF	800H-W216	START	800H-W226
RAPIDE	800H-W204F	ARRÊTER	800H-W216F	MARCHE	800H-W226F
FORWARD	800H-W205	ON	800H-W217	TEST	800H-W228
AVANT	800H-W205F	DÉMARRER	800H-W217F	ESSAI	800H-W228F
FULL SPEED	800H-W206	OPEN	800H-W218	THIRD SPEED	800H-W229
VITESSE MAX	800H-W206F	OUVRIER	800H-W218F	VITESSE 3	800H-W229F
HIGH	800H-W207	OUT	800H-W219	I	800H-W281
HAUT	800H-W207F	SORTIR	800H-W219F	O	800H-W284
IN	800H-W208	RAISE	800H-W220	LEFT	800H-W286
ENTRER	800H-W208F	ÉLEVER	800H-W220F	GAUCHE	800H-W286F
INCH	800H-W209	RESET	800H-W221	RIGHT	800H-W287
POUCE	800H-W209F	RÉARMER	800H-W221F	DROITE	800H-W287F
JOG	800H-W210	REVERSE	800H-W222	UP	800H-W288
À COUPS	800H-W210F	ARRIERE	800H-W222F	EN HAUT	800H-W288F

* 12 characters max.

10

Marking	Red — Type 4/4X
	Cat. No.
Blank	800H-W400
Customer-Specified*	800H-W400E
EMERG. STOP	800H-W472
ARRÊT URGENT	800H-W472F
STOP	800H-W471
ARRET	800H-W471F
O	800H-W484

* 12 characters max.

Approximate Dimensions

Dimensions in inches (millimeters). Dimensions are not intended to be used for manufacturing purposes.

Mounting Instructions for Push Buttons with Shallow Blocks, Mini Blocks, Logic Reed Blocks, Sealed Switch Blocks, and Time Delay Blocks (see footnotes for exceptions)

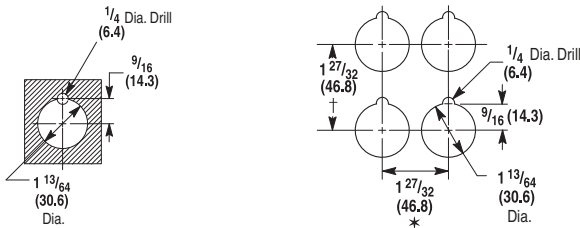

- * Change to 2-1/4 in. (57.2 mm) for transformer type pilot light, push-to-test pilot lights, illuminated selector switches, and all push-pull buttons.
Note: Large legend plate requires minimum horizontal spacing of 2-15/32 in. (62.7 mm).
- ⊛ Vertical minimum spacing dimension changes for the following legend plates: jumbo 2-15/32 in. (62.7 mm); large 2-7/16 in. (61.9 mm); cluster pilot light and 2-, 3-, 4-way switches 2-1/16 in. (52.4 mm).

Sketch illustrates the minimum distance between centerlines when mounting Bulletin 800T/H controls either side-by-side, facing each other, or one above the other. When control units are mounted so that the contact block terminals face each other, the 2-1/4 in. (57.2 mm) dimension must be used in order to get proper electrical clearance. When control units are mounted so that the contact block terminals do not face each other, the 1-27/32 in. (46.8 mm) dimension can be used.

Typical Panel Cut-Out

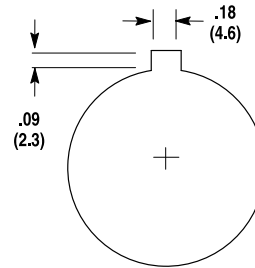

Panel Thickness — Kits are shipped with three 1/16 in. (1.58 mm) gaskets. Refer to table below for number of washers required for various panel thicknesses.

	1/16 in. (1.6 mm) (16 Gauge)	7/64 in. (2.8 mm) (12 Gauge) 9/64 in. (3.6 mm) (10 Gauge)	3/16 in. (4.8 mm) Panel	Thicker Than 3/16 in. (4.8 mm) Panel	Thicker Than 1/4 in. (6.4 mm) Panel
800T	3 washers	2 washers	1 washer	Counterbore to 3/16 in. (4.8 mm)	Counterbore to 3/16 in. (4.8 mm)
800H	4 washers	3 washers	2 washers	1 washer	Counterbore to 1/4 in. (6.4 mm)

Mounting Instructions for 18 mm Small Pilot Lights

Type A Legend Plate

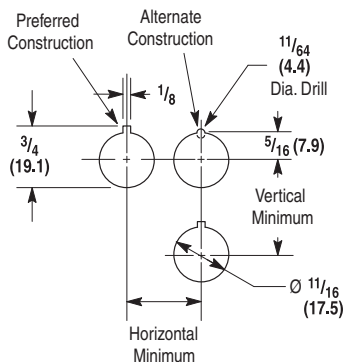

Cat. No. 800T-N515

Type B Legend Plate

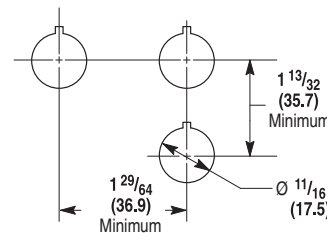

Device	Dimensions	
	Horizontal	Vertical
800T-PS, PSD, PST, QS, QST and RST	31/32 (24.6)	1-5/32 (29.4)
800T-PSDT	1-3/64 (26.6)	1-15/64 (31.4)

30.5 mm Push Buttons

Approximate Dimensions

Dimensions in inches (millimeters). Dimensions are not intended to be used for manufacturing purposes.

Legend Plate Dimensions (Bul. 800T Only)

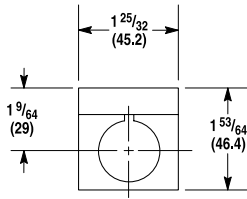

Standard Legend Plate

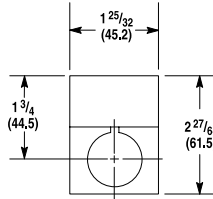

Jumbo Legend Plate

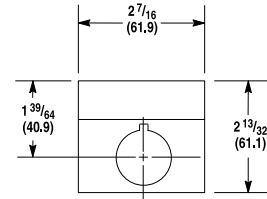

**Large Legend Plate
(Automotive Industry Type)**

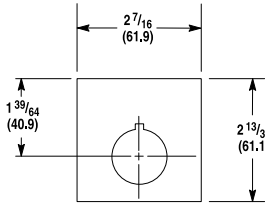

**Large Size
Push-Pull/Twist Legend Plate
Cat. No. 800T-X647***

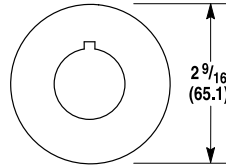

**Round
Cat. No. 800T-X646***

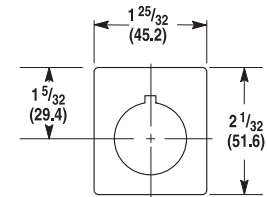

**Cluster Pilot Light and
2-3-4 Way Switch
Silver Legend Plate
Cat. No. 800T-X619**

* For panel mounting only. Not for use with Allen-Bradley enclosures.

Legend Plate Dimensions (Bul. 800H Only)

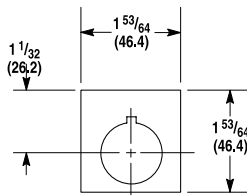

**Type 4/4X
Standard Legend Plate**

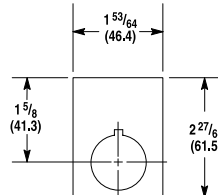

**Type 4/4X
Jumbo Legend Plate**

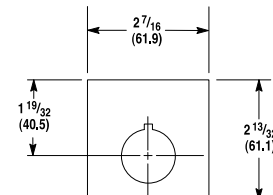

**Type 4/4X
Large Legend Plate
(Automotive Industry Type)**

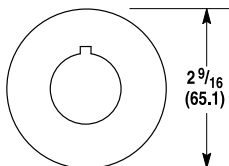

**Type 4/4X
Round**

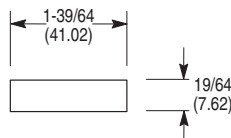

**Type 4/4X
Standard Legend Plate
(Flip Lever Operators)**

Legend Plate Dimensions (Bul. 800T 18 mm Pilot Lights Only)

Legend Plate for Small Pilot Light Type A Legend

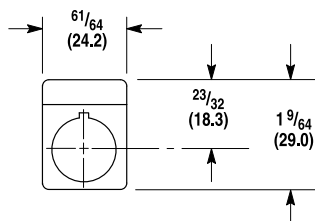

Cat. No. 800T-N515

Legend Plate for Small Pilot Light Type B Legend

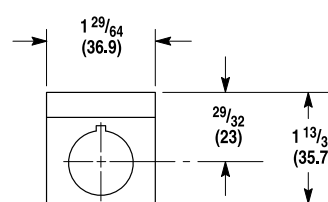

**Cat. No. 800T-N516
(Automotive Industry Type)**

Dimensions in inches (millimeters). Dimensions are not intended to be used for manufacturing purposes.

Blocks (Bul. 800T Only)

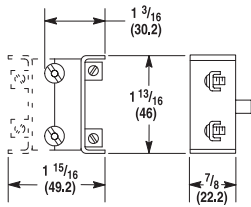

Mini Contact Block
 7/8 (22.2) Deep

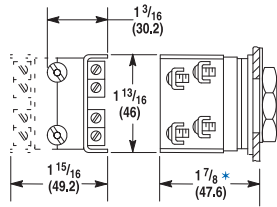

**Shallow, PentUFF,
 and Logic Reed Contact Blocks**
 1-1/8 (28.6) Deep

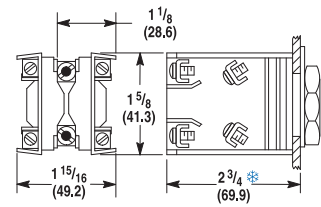

Sealed Switch Block
 2 (50.8) Deep

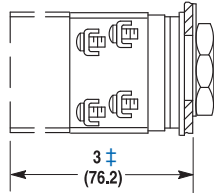

Tandem Mounting
 (2 shallow contact
 blocks stacked)

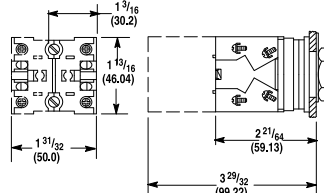

Stackable Sealed Switch Block
 1.58 (40.1) Deep

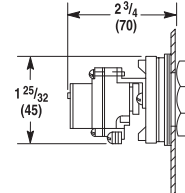

Time Delay Contact Block
 (For Push Buttons Only)

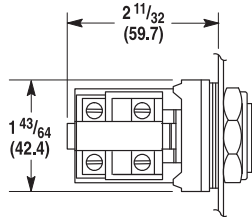
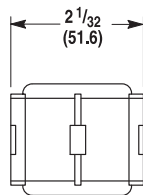

Snap Action Contact Block (For Push Button Only)

- * Dimension shown is for push buttons. Selector switch dimension is 2-1/32 in. (51.6 mm).
- ⊛ Dimension shown is for push buttons. Selector switch dimension is 2-27/32 in. (72.2 mm).
- ± Dimension shown is for push buttons. Selector switch dimension is 3-5/32 in. (80.2 mm).

Blocks (Bul. 800H Only)

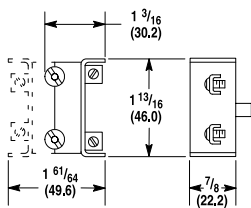

Mini Contact Block

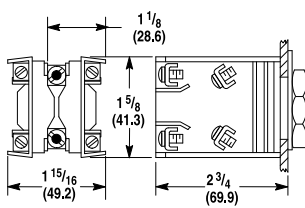

Sealed Switch Block
 2 (50.8) Deep

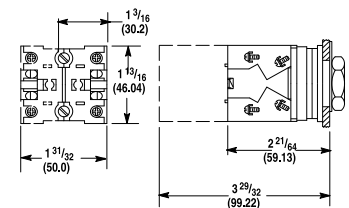

Stackable Sealed Switch Block
 1.58 (40.1) Deep

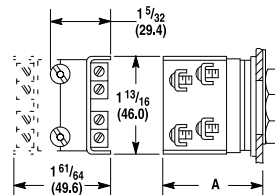

**Shallow, PentUFF and Logic
 Reed Contact Blocks**

Dim.	Momentary Push Button	Maintained Push Button	Selector Switch
A	2 (50.8)	2 (50.8)	1-29/32 (48.4)

Operator Extension Behind Panel — When mounted with thrust washer, trim washer, or notched legend plate and correct number of rubber washers.

30.5 mm Push Buttons

Approximate Dimensions

Dimensions in inches (millimeters). Dimensions are not intended to be used for manufacturing purposes.

Push Buttons and Switches (Bul. 800T Only)

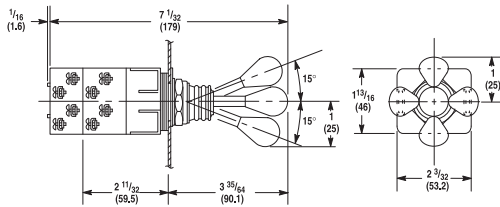

2-3-4 Way Switch
Shipping Wt. with 2 Contact Blocks 6 oz (0.17 kg)
Shipping Wt. with 4 Contact Blocks 8-1/2 oz (0.24 kg)

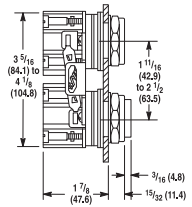

Mechanically Interlocked Maintained Contact Push Button
Shipping Wt. 1 lb (0.45 kg)

Push Buttons and Pilot Lights

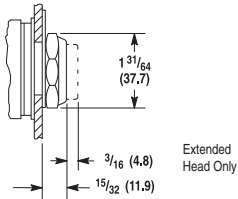

Flush and Extended Head Push Button
Shipping Wt. 5-1/2 oz (0.15 kg)

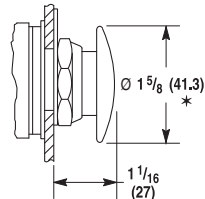

Mushroom Head Push Button
Shipping Wt. 7-1/2 oz (0.21 kg)

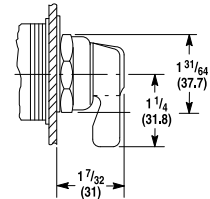

Non-Illuminated Knob Lever and Standard Knob Selector Switch
Shipping Wt. 6 oz (0.17 kg)

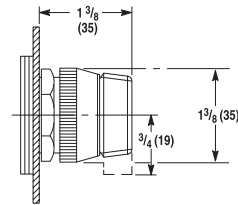

Illuminated Knob Lever and Standard Knob Selector Switch
Shipping Wt. 6 oz (0.17 kg)

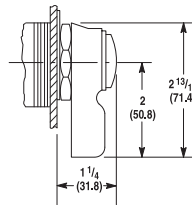

Wing Lever Selector Switch
Shipping Wt. 8 oz (0.22 kg)

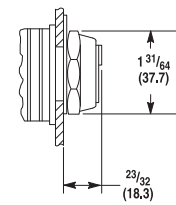

Coin Slot Selector Switch
Shipping Wt. 6 oz (0.17 kg)

* Except jumbo which is 2-1/4 (57.2).

Operator Extension in Front of Panel (Bul. 800T Only)

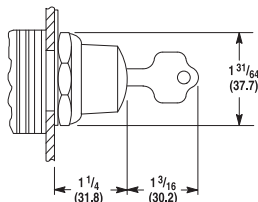

Key Operated Selector Switch
Shipping Wt. 12 oz (0.34 kg)

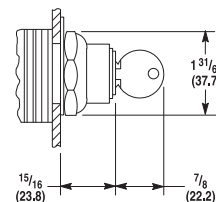

Push Button with Cylinder Lock
Shipping Wt. 12 oz (0.34 kg)

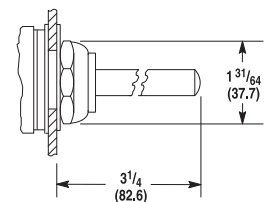

Wobble Stick
Shipping Wt. 9 oz (0.25 kg)

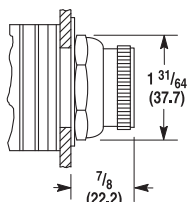

Selector Push Button
Shipping Wt. 6 oz (0.17 kg)

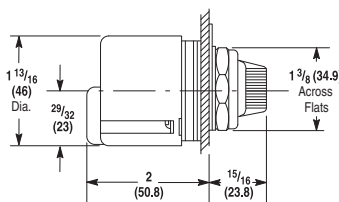

Type J Potentiometer Unit
Shipping Wt. 4 oz (0.11 kg)

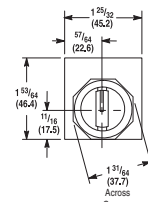

Dimensions in inches (millimeters). Dimensions are not intended to be used for manufacturing purposes.

Push Buttons and Switches (Bul. 800H Only)

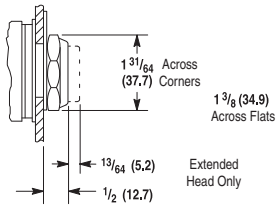

Bootless Flush and Extended Head Momentary Contact Push Button
Shipping Weight. 5-1/2 oz (0.16 kg)

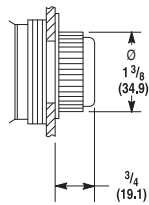

Booted Flush and Extended Head Momentary Contact Push Button
Shipping Weight. 5-1/2 oz (0.16 kg)

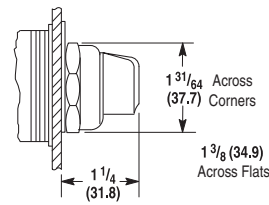

Standard Knob Selector Switch Non-Illuminated
Shipping Weight. 6 oz (0.17 kg)

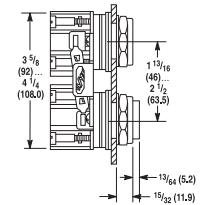

Bootless Maintained Contact Push Buttons

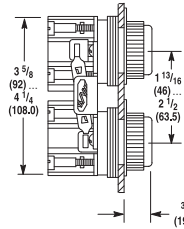

Booted Maintained Contact Push Buttons
Shipping Weight. 1 lb (0.45 kg)

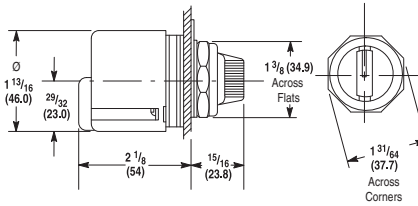

Type J Potentiometer Unit
Shipping Weight. 7 oz (0.20 kg)

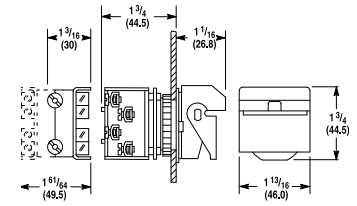

Type 4 Flip Lever
Shipping Weight. 8 oz (0.14 kg)

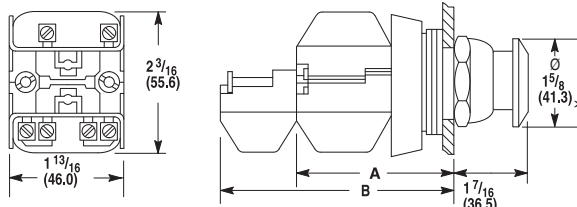

Mushroom Head — Maintained and Momentary

Non-Illuminated Mushroom and Push-Pull Push Buttons				
Cat. No. Suffix	Description	Dimensions		Shipping Weights
D4	One Shallow Block	A	2-1/32 (51.6)	5 oz (0.14 kg)
A1, A5 and A7	Two Shallow blocks	A	2-1/32 (51.6)	6 oz (0.17 kg)
B6	Two Shallow Blocks and Two Mini Blocks	B	2-7/8 (73.0)	8 oz (0.22 kg)

* Jumbo versions are 2-1/4 (57.2).

Bulletin 800T/H
30.5 mm Push Buttons
 Approximate Dimensions

Dimensions in inches (millimeters). Dimensions are not intended to be used for manufacturing purposes.

Pilot Light and Illuminated Devices (Bul. 800T Only)

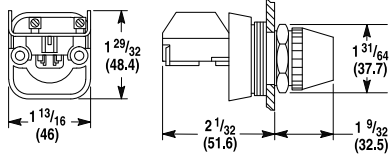

Full Voltage, Neon and Dual Input Pilot Light
Shipping Wt. 5 oz (0.14 kg)

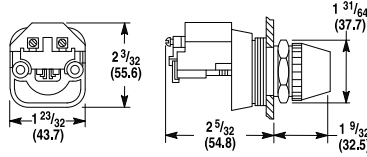

Transformer Type Pilot Light
Shipping Wt. 8 oz (0.22 kg)

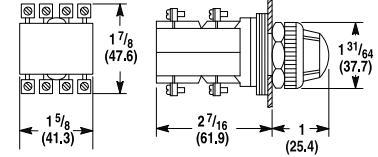

Cluster Pilot Light
Shipping Wt. 12 oz (0.34 kg)

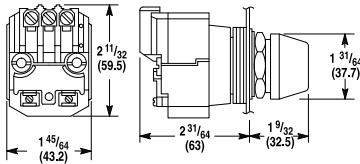

Dual Input Transformer Type Pilot Light

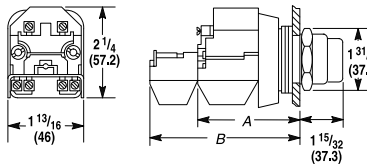

Transformer Type (Push-to-Test Pilot Light and Illuminated Push Button)

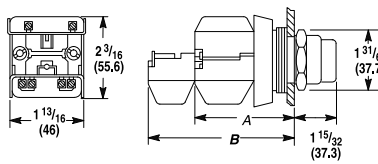

Full Voltage, Neon and Dual Input Type (Push-to-Test Pilot Light and Illuminated Push Button)

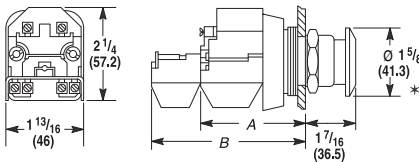

Push-Pull and Twist or Pull Release Units (Transformer Type Illuminated)

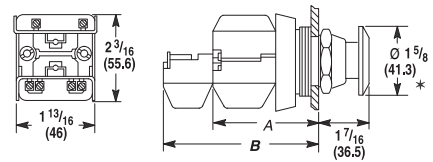

Push-Pull and Twist or Pull Release Units (Full Voltage, Neon and Dual Input Illuminated and All Non-Illuminated)

* Jumbo mushroom versions are 2-1/4 in. (57.2 mm) diameter.

Push-to-Test Pilot Lights Illuminated Push Buttons and Illuminated Push-Pull Buttons							Non-Illuminated Push-Pull Buttons					
Cat. No. Suffix*	Description	Transformer Type		Full Voltage or Neon Type		Cat. No. Suffix	Description	Transformer Type				
		Dim.	Ship. Wt.	Dim.	Ship. Wt.			Dim.	Ship. Wt.			
D4	Transformer or Terminal Module and One Shallow Contact Block	A	2-5/32 (54.8)†	9 oz. (0.25 kg)	A	2-1/32 (51.6)	7 oz. (0.25 kg)	D4	One Shallow Contact Block	A	2-1/32 (51.6)	5 oz. (0.14 kg)
A1 and A7	Transformer or Terminal Module and One Shallow Block and One Mini Contact Block	B	2-7/8 (73)	10 oz. (0.28 kg)	B	2-7/8 (73)	8 oz. (0.22 kg)	A4 A5 A7	Two Shallow Contact Blocks	A	2-1/32 (51.6)	6 oz. (0.17 kg)
AP D1P D2P	Transformer or Terminal Module and One Sealed Switch Contact Block	A	3-1/32 (77)	10 oz. (0.28 kg)	A	2-29/32 (73.8)	8 oz. (0.22 kg)	B6	Two Shallow Blocks and Two Mini Contact Blocks	B	2-7/8 (73)	8 oz. (0.22 kg)

* Applies to illuminated push-pull push buttons only.

† Dual input type pilot light dimension is 2-13/32 in. (61.1 mm).

10

18 mm Small Pilot Lights

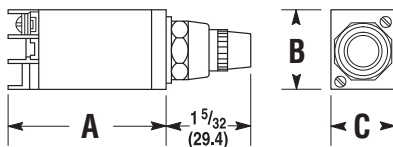

Small Pilot Light Including Push-To-Test
Shipping Weight 3 oz (0.08 kg)

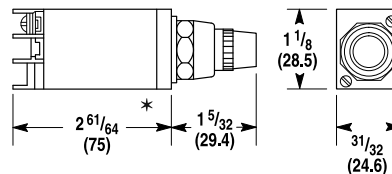

Small Pilot Light Dual Input (Diode)
Shipping Weight 3 oz (0.08 kg)

Device	A	B	C
800T-PS, -PSD, -PST, -QS, -QST, and -RST	2-1/4 (57.2)	1-1/16 (27)	27/32 (21.4)
800T-PSDT	2-61/64 (75)	1-15/64 (31.4)	31/32 (24.6)

* Transfer dual input pilot light dimension is 2-31/32 in. (75.4 mm).

Dimensions in inches (millimeters). Dimensions are not intended to be used for manufacturing purposes.

Push-to-Test Pilot Light and Illuminated Devices (Bul. 800H Only)

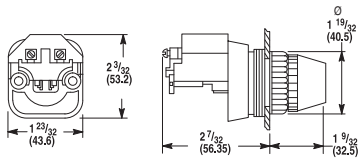

Transformer Type Pilot Light
 (Incandescent and LED)
Shipping Weight. 12 oz (0.34 kg)

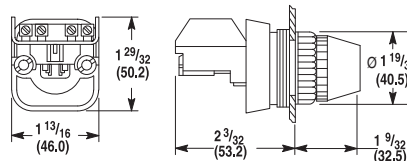

Full Voltage and Dual Input Diode Type
 Pilot Light (Incandescent, Neon, LED)
Shipping Weight. 5 oz (0.14 kg)

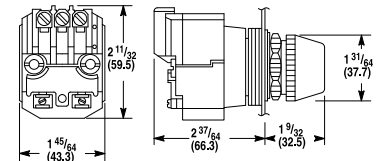

Dual Input Transformer Type Pilot Light
Shipping Weight. 14 oz (0.40 kg)

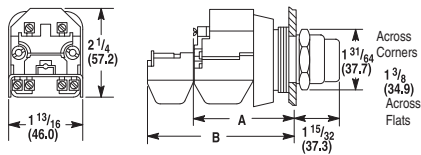

Push-to-Test Pilot Light and Illuminated
 Push Button
 (Transformer Type: Incandescent, LED)

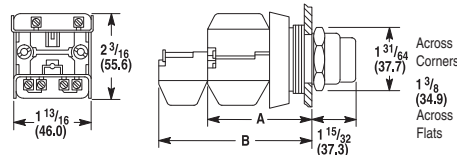

Push-to-Test Pilot Light and
 Illuminated Push Button
 (Full Voltage: Incandescent, LED, Neon;
 and Dual Input Type)

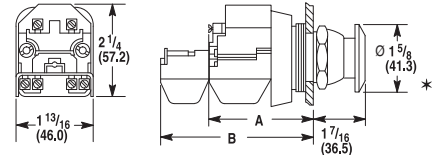

Momentary Mushroom, Push-Pull and Twist or
 Pull Release Units
 (Transformer Type: Incandescent, LED; Illuminated)

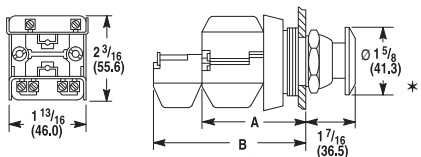

Momentary Mushroom, Push-Pull and
 Twist or Pull Release Units
 (Full Voltage: Incandescent, LED, Neon;
 and Dual Input Illuminated)

Push-to-Test Pilot Lights
Illuminated Push Buttons, Illuminated Push-Pull and Twist or Pull Release Push Buttons

Cat. No. Suffix*	Description	Transformer Type			Full Voltage or Neon Type		
		Dimension	Shipping Weight		Dimension	Shipping Weight	
D4	Transformer or Terminal Module and One Shallow Contact Block	A	2-5/32 (54.8)‡	9 oz. (0.25 kg)	A	2-1/32 (51.6)§	7 oz. (0.20kg)
A1 and A7	Transformer or Terminal Module, One Shallow Block and One Mini Contact Block	B	2-7/8 (73)	10 oz. (0.28 kg)	B	2-7/8 (73)	8 oz. (0.22 kg)
AP	Transformer or Terminal Module and One Sealed Switch Contact Block	B	2-29/32 (73.8)	10 oz. (0.28 kg)	B	2-29/32 (73.8)	8 oz. (0.22 kg)

* Jumbo mushroom versions are 2-1/4 in. (57.2 mm) diameter.

‡ Applies to illuminated push-pull push buttons only.

‡ Dual input type pilot light dimension is 2-13/32 in. (61.1 mm).

§ Dual input type pilot light dimension is 2-9/32 in. (57.9 mm).

Bulletin 800T/H
30.5 mm Push Buttons
 Approximate Dimensions

Dimensions in inches (millimeters). Dimensions are not intended to be used for manufacturing purposes.

Accessories

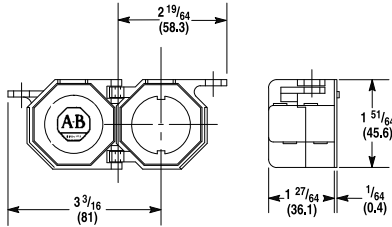

Push Button Padlocking Cover
 (not for use with Jumbo Mushroom Head devices)
Shipping Wt. 1 oz (0.03 kg)

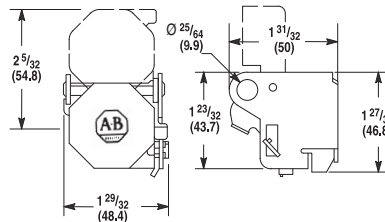

Selector Switch and Potentiometer Unit Padlocking Cover

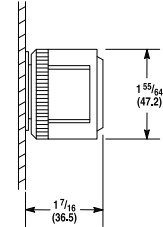

Protective Ring and Push-Pull Illuminated or Non-Illuminated Operators

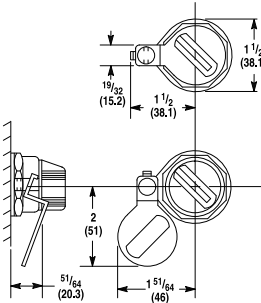

Selector Switch Padlocking Attachment

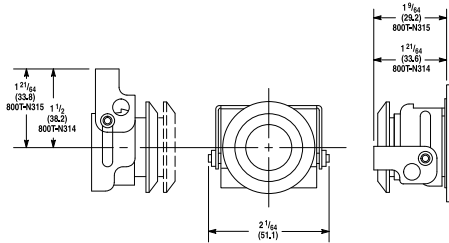

Push-Pull Padlocking Attachment and Metal Mushroom Push Button Padlocking Attachment

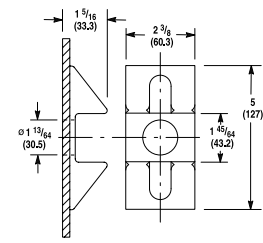

Ramp Guard for Push-Pull Illuminated or Non-Illuminated Operators

Accessories (Bul. 800H Only)

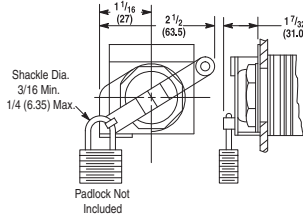

Locking Attachment for Extended, Non-Illuminated Push Buttons

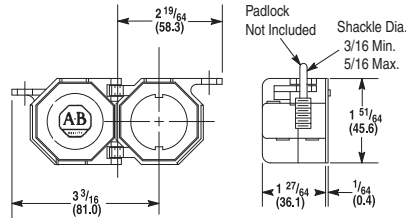

800H-N140 Locking Cover for 2-Position Non-Illuminated Maintained Twist or Pull Release and Standard Knob Selector Switch (1-5/8 (41.3) Mushroom Head only)

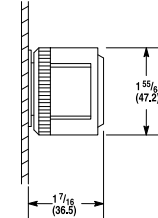

Protective Ring for 2-Position Push-Pull/Twist Illuminated or Non-Illuminated Operators

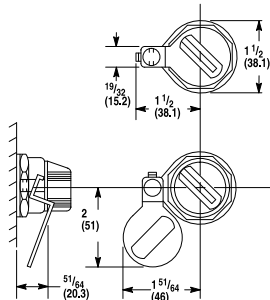

Non-Illuminated Selector Switch Padlocking Adjustment

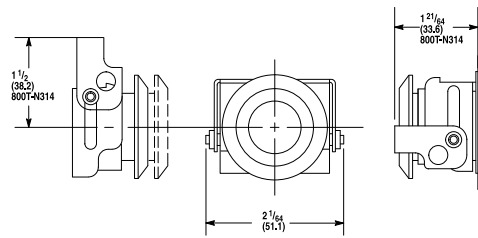

Push-Pull/Twist Padlocking Attachment

Dimensions in inches (millimeters). Dimensions are not intended to be used for manufacturing purposes.

Die Cast Enclosures (Bul. 800T Only)

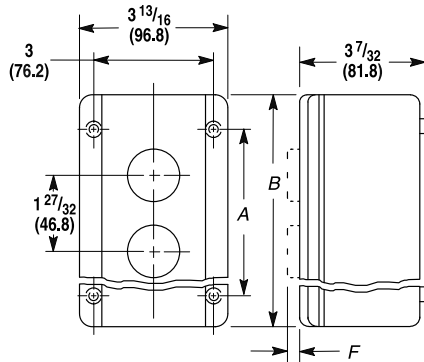

Enclosure Dimensions					
Dim.	No. of Units				
	1	2	3	4	6
A	2-3/4 (69.9)	4-1/2 (114.3)	6-1/4 (158.8)	8 (203.2)	12-1/8 (308)
B	4-3/16 (106.4)	5-7/8 (144.2)	7-9/16 (192.1)	9-1/2 (241.3)	13-1/2 (342.4)

Note: Mounting holes (4) — Screw shaft 13/64 in. (5.16 mm) max. diameter.

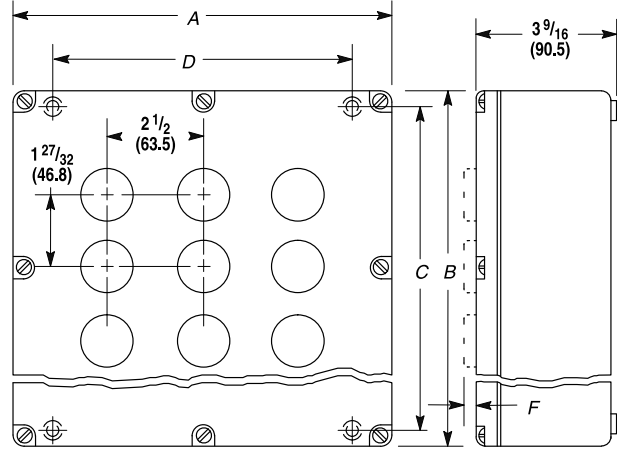

Enclosure Dimensions				
Dim.	No. of Units			
	6	9	12	16
A	7-1/4 (184.2)	9-3/4 (247.7)	9-3/4 (247.7)	12-1/2 (317.5)
B	9 (228.6)	9 (228.6)	11 (279.4)	11 (279.4)
C	8-1/4 (209.6)	8-1/4 (209.6)	10-1/8 (257.2)	10-1/8 (257.2)
D	5-3/8 (136.5)	7-7/8 (200)	7-7/8 (200)	10-5/8 (269.9)

Note: Mounting holes (4) — Screw shaft 7/32 in. (5.56 mm) max. diameter.

F Dimension

Type of Unit		Dimension F
Push Buttons	Flush Extended	15/32 (11.9)
	Extended	21/32 (16.7)
	Mushroom	1 (25.4)
	Selector	7/8 (22.2)
	Cylinder Lock	1-13/16 (46)
Selector Switches	Standard	1-7/32 (30.9)
	Cylinder Lock	2-7/16 (61.9)
	Coin Slot	3/4 (19.1)
Pilot Light		1-1/8 (28.6)
Potentiometers		1-1/16 (27)

Conduit Openings

General Class	Description	No. of Units*						
		1...4	6	9	12	16	20	25
Surface Mounted Enclosure	Die Cast	3/4 in. 14 N.P.T.	1 in. 11-1/2 N.P.T.	1 in. 11-1/2 N.P.T.	1 in. 11-1/2 N.P.T.	1-1/2 in. 11-1/2 N.P.T.	—	—

* Number of units that can be mounted in the enclosure.

Bulletin 800T/H
30.5 mm Push Buttons
 Approximate Dimensions

Dimensions in inches (millimeters). Dimensions are not intended to be used for manufacturing purposes.

Enclosures (Bul. 800T Only), Continued
Pendant Stations

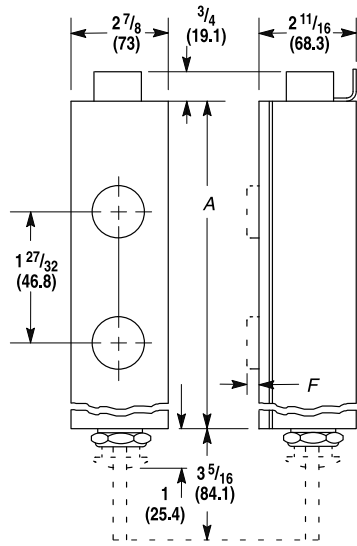

No. of Units	Dimension A
2	5-13/16 (147.6)
3	7-21/32 (194.5)
4	9-1/2 (241.3)
5	11-11/32 (288.1)
6	13-3/16 (335)
7	15-1/32 (381.7)
8	16-7/8 (428.6)
9	18-23/32 (475.4)
10	20-9/16 (522.3)

Sheet Metal Enclosures

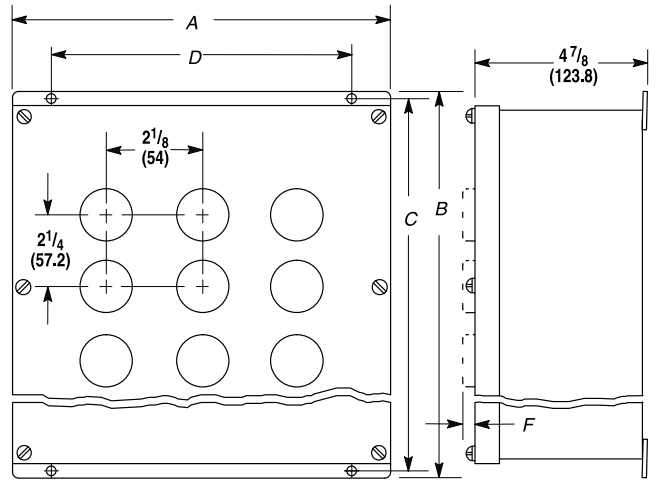

Dim.	Enclosure Dimensions					
	No. of Units					
	6	9	12	16	20	25
A	6-15/16 (176.2)	8-11/16 (220.7)	8-11/16 (220.7)	10-7/16 (265.1)	10-7/16 (265.1)	12-1/2 (317.5)
B	11-1/8 (282.6)	11-1/8 (282.6)	13-1/2 (342.9)	13-1/2 (342.9)	15-7/8 (403.2)	15-7/8 (403.2)
C	10-1/2 (266.7)	10-1/2 (266.7)	12-7/8 (370)	12-7/8 (370)	15-1/4 (387.4)	15-1/4 (387.4)
D	5 (127)	6-3/4 (171.5)	6-3/4 (171.5)	8-1/2 (215.9)	8-1/2 (215.9)	10-1/4 (260.4)

Note: Mounting holes (4) — Screw shaft 7/32 in. (5.56 mm) max. diameter.

F Dimension

Type of Unit		Dimension F
Push Buttons	Flush Extended	15/32 (11.9)
	Extended	21/32 (16.7)
	Mushroom	1 (25.4)
	Selector	7/8 (22.2)
	Cylinder Lock	1-13/16 (46)
Selector Switches	Standard	1-7/32 (30.9)
	Cylinder Lock	2-7/16 (61.9)
	Coin Slot	3/4 (19.1)
Pilot Light		1-1/8 (28.6)
Potentiometers		1-1/16 (27)

10 Conduit Openings

General Class	Description	No. of Units*					
		1...4	6	9	12	16	20
Surface Mounted Enclosure	Sheet Metal	None — Drilled to suit by customer.					
Pendant Type Enclosure	with Opening in Bottom	2...5			6...10		
		1 (25.4) Conduit Hub			1-1/4 (31.8) Conduit Hub		
	with Opening in Cover	1 (25.4) Conduit Hub			1-1/4 (31.8) Conduit Hub		

* Number of units that can be mounted in the enclosure.

Dimensions in inches (millimeters). Dimensions are not intended to be used for manufacturing purposes.

Enclosures (Bul. 800H Only)

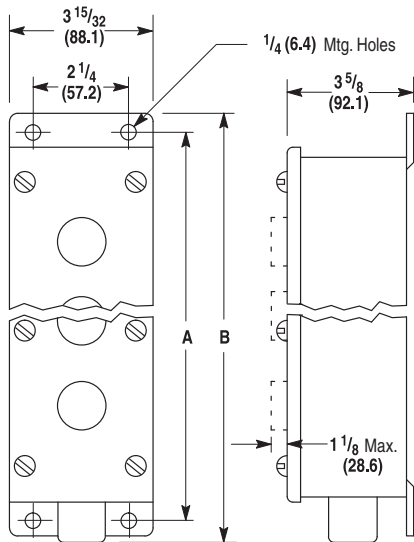

Type 4/4X/13 Stainless Steel
 Watertight, Oiltight, Corrosion Resistant Enclosure

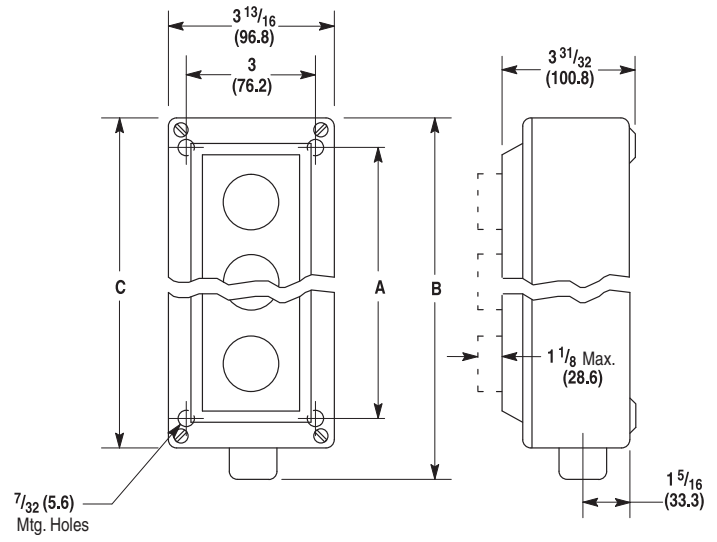

Type 4/4X/13 Rosite Glass Polyester
 Watertight, Oiltight, Corrosion Resistant Enclosure

Dimension	Type 4/4X/13 Stainless Steel							
	Number of Units							
	1	2	3	4	5	6	7	8
A	5-5/32 (131)	7 (177.8)	8-27/32 (224.6)	10-11/16 (271.5)	12-17/32 (318.3)	14-3/8 (365.1)	16-7/32 (412)	18-1/16 (458.8)
B	6-13/32 (162.7)	8-1/4 (209.6)	10-1/8 (257.2)	11-31/32 (304)	14-1/32 (356.4)	15-7/8 (403.2)	17-3/4 (450.8)	19-19/32 (497.7)
C	—				—			
Conduit Knockout Size	—				—			
Pipe Tap Size	3/4 (19.1)				1 (25.4)			
Approximate Shipping Wt. [lbs (kg)]	2-3/4 (1.3)	3-3/4 (1.7)	4-3/4 (2.2)	5-3/4 (2.6)	6-3/4 (3.1)	7-3/4 (3.5)	8-3/4 (4)	9-3/4 (4.4)

Dimension	Type 4/4X/13 Rosite					
	Number of Units					
	1	2	3	4	5	6
A	4-1/2 (114.3)	4-1/2 (114.3)	6-1/4 (158.8)	8 (203.2)	12-1/8 (308)	12-1/8 (308)
B	7-1/32 (178.6)	7-1/32 (178.6)	8-23/32 (221.5)	10-21/32 (270.7)	14-7/8 (377.8)	14-7/8 (377.8)
C	5-7/8 (149.2)	5-7/8 (149.2)	7-9/16 (192)	9-1/2 (241.8)	13-1/2 (342.9)	13-1/2 (342.9)
Conduit Knockout Size	—			—		
Pipe Tap Size	3/4 (19.1)			1 (25.4)		
Approximate Shipping Wt. [lbs (kg)]	2 (0.9)	2 (0.9)	2-1/2 (1.1)	3 (1.4)	4 (1.8)	4 (1.8)

30.5 mm Push Buttons

Approximate Dimensions

Dimensions in inches (millimeters). Dimensions are not intended to be used for manufacturing purposes.

Enclosures (Bul. 800H Only), Continued

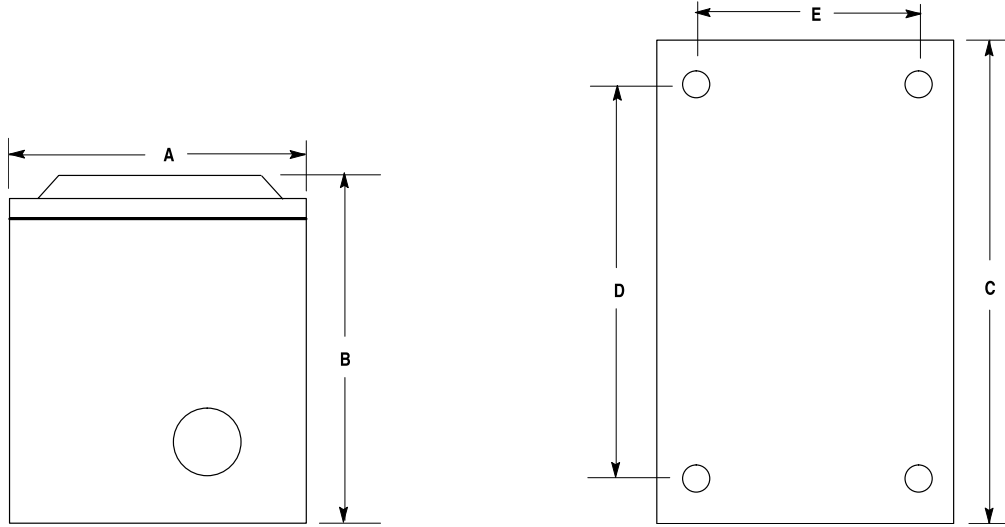

Dimension	Fiberglass Type 4/4X/12/13		
	Number of Units		
	1	2	3
A x B x C	4-1/2 x 5-3/16 x 6 (114.3 x 131.8 x 152.4)	4-1/2 x 5-3/16 x 8 (114.3 x 131.8 x 203.2)	6-1/2 x 5-7/16 x 8 (165.1 x 138.1 x 203.2)
D x E	4-3/4 x 2 (120.7 x 50.8)	6-3/4 x 2 (171.5 x 50.8)	6-3/4 x 4 (171.5 x 101.6)
Conduit Knockout Size	3/4 (19.1)	1 (25.4)	1 (25.4)
Approximate Shipping Wt. [lb (kg)]	2 (0.9)	1/4 (1.0)	3 (1.4)

Dimensions are shown in millimeters (inches). Dimensions are not intended to be used for manufacturing purposes.

Enclosures (Bul. 800H Only), Continued

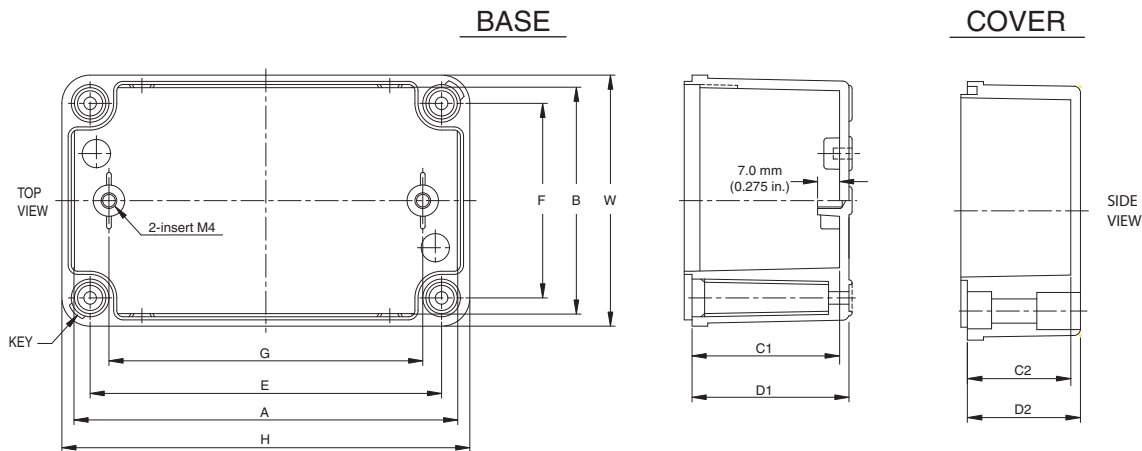

Thermoplastic Polyester Type 4/4X

Cat. No.	Overall Dimension				Inside Dimension				Enclosure Mounting Dimension		Mounting Plate Mounting Dim.
	H	W	D1	D2	A	B	C1	C2	E	F	
800H-1HZ4	110 (4.33)	80 (3.15)	50 (1.97)	20 (0.79)	104 (4.09)	74 (2.91)	46.5 (1.83)	16.5 (0.65)	92 (3.62)	62 (2.44)	80 (3.15)
800H-2HZ4	130 (5.12)	80 (3.15)	50 (1.97)	35 (1.38)	120 (4.72)	70 (2.76)	46.5 (1.83)	31.5 (1.24)	112 (4.41)	62 (2.44)	100 (3.94)
800H-3HZ4	180 (7.09)	80 (3.15)	50 (1.97)	35 (1.38)	170 (6.69)	70 (2.76)	46.5 (1.83)	31.5 (1.24)	162 (6.38)	62 (2.44)	150 (5.91)
800H-4HZ4	250 (9.84)	80 (3.15)	50 (1.97)	35 (1.38)	240 (9.45)	70 (2.76)	46.5 (1.83)	31.5 (1.24)	232 (9.13)	62 (2.44)	220 (8.66)

Typical Pilot Light Wiring Diagrams

See applicable codes and laws

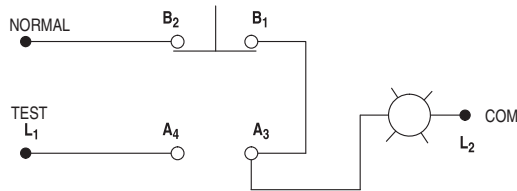

Push-to-Test Pilot Light Device Schematic

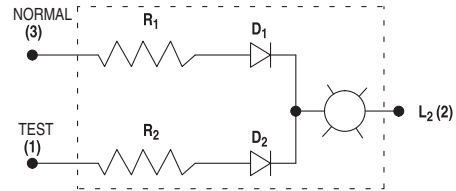

Dual Input Diode Pilot Light Device Schematic

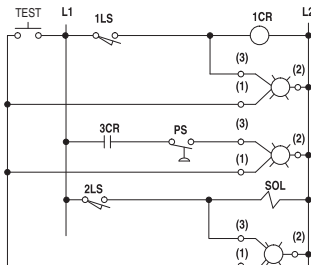

Dual Input Pilot Light Typical Application Wiring Diagram

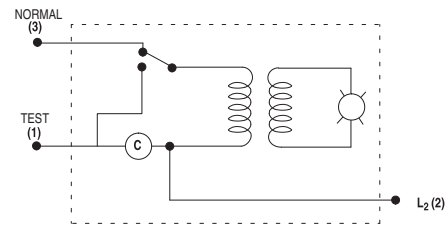

Dual Input Pilot Light Transformer Type Device Schematic

22.5 mm Push Buttons

Product Overview



Bulletin 800F Plastic and Metal Operators

- 22.5 mm mounting hole
- IP65/66, Type 4/4X/13
- Internationally rated operators

Table of Contents

See below.

TABLE OF CONTENTS

Description	Page
Specifications	10-67
Quick Selection	10-70
Push Buttons, Momentary	
Non-Illuminated — Flush, Extended, Guarded.....	10-73
Non-Illuminated — with Two-Color Molded Legend Caps....	10-74
Illuminated — Flush, Extended, Guarded.....	10-75
Push Buttons, Alternate Action	
Non-Illuminated — Flush.....	10-76
Illuminated — Flush.....	10-76
Pilot Light Operators	10-77
Selector Switches	
Non-Illuminated, 2-Position.....	10-78
Illuminated, 2-Position.....	10-79
Non-Illuminated, 3-Position.....	10-80
Illuminated, 3-Position.....	10-81
Non-Illuminated, 4-Position.....	10-82
Key Selector Switches	
2-Position	10-83
3-Position	10-84
Emergency Stop Operators	
Twist-to-Release and Push-Pull Mushroom Operators	
Non-Illuminated	10-85
Illuminated	10-85
Key Release Mushroom Operators	10-85
Momentary Mushroom Operators	
Push-Pull Mushroom Operator, 3-Position	10-89
Non-Illuminated.....	10-90
Illuminated.....	10-91

Description	Page
Multi-Function Operators	
2-Function, Momentary, Non-Illuminated	10-92
2-Function, Momentary, Illuminated	10-93
3-Function, Momentary, Non-Illuminated	10-94
Reset Operators	10-95
Single-Turn Potentiometer Assembly	10-96
Key Operated Selector Switch — SensEject™	10-96
Selector Push Button Operators	10-97
Toggle Switch Operators	10-98
Back-of-Panel Components	
Contact Blocks.....	10-99
Power Modules	10-99
Power Modules with Contact Blocks.....	10-100
Enclosures	10-103
Assembled Stations	10-103
Assembled Stations with DeviceNet	10-105
Pendant Stations	10-106
Accessories	
Miscellaneous	10-107
Guards	10-109
Locking Attachments.....	10-110
Replacement Lamps	10-111
Color Caps, Lenses, Diffusers without Text	10-112
Two-Color Molded Legend Caps.....	10-113
E-Stop Legends.....	10-113
Legend Plates.....	10-114
Custom Laser-Engraved Caps/Diffusers.....	10-115
Legend Text.....	10-116
Approximate Dimensions	10-120

Bulletin 800FP Plastic Operators

- IP65/66, Type 4/4X/13
- Engineering grade thermoplastics
- Chemical-resistant for harsh environments



Bul. 800FP Plastic Operators

Bulletin 800FM Metal Operators

- IP65/66, Type 4/13
- Die-cast metal construction
- Chrome-plated



Bul. 800FM Die-Cast Metal Operators



Overview, Continued

3-Across x 2-Deep Back-of-Panel (6 Circuits Max.)

- Rugged snap-fit design for plastic or metal latch
- Stackable contact blocks
- Rotating collar for easy one-hand latch removal
- Color-coded contact block plungers for contact identification



Plastic Latch with Contact Block



Metal Latch with Contact Block

Assembly Overview

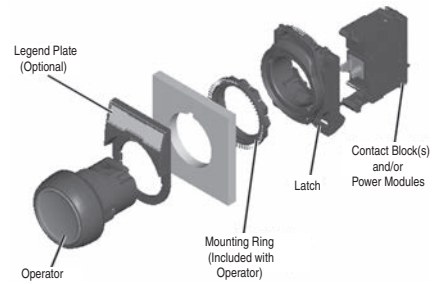

Specifications*

Front-of-Panel (Operators)

Description		Mechanical Ratings	
		Plastic (Bulletin 800FP)	Metal (Bulletin 800FM)
Vibration (assembled to panel)		Tested at 10...2000 Hz, 1.52 mm displacement (peak-to-peak) max./10 G max. for 3 hr duration, no damage	
Shock		Tested at 1/2 cycle sine wave for 11 ms; no damage at 100 G	
Degree of protection*		IP65/66 (Type 3/3R/4/4X/12/13)	IP65/66 (Type 3/3R/4/12/13)
Mechanical durability per EN 60947-5-1 (Annex C)	10 000 000 Cycles	Momentary push buttons, momentary mushroom	
	1 000 000 Cycles	Multi-function, selector switch, key selector switch, selector jog, SensEject™ key selector switch	
	500 000 Cycles	Non-illuminated push-pull E-stop‡	
	300 000 Cycles	Twist-to-release E-stop, illuminated push-pull E-stop‡, alternate action push buttons	
	100 000 Cycles	Potentiometer, toggle switch	
Operating forces (typical with one contact block)		Flush/extended = 5 N, E-stop = 36 N Mushroom = 9 N	
Operating torque (typical application with one contact block)		Selector switch = 0.25 N•m (2.2 lb•in)	
Mounting torque	Plastic	1.7 N•m (15 lb•in)	
	Metal	4.4 N•m (40 lb•in)	
Environmental			
Temperature range (operating)		-25...+70 °C (-13...+158 °F)§	
Temperature range (short term storage)		-40...+85 °C (-40...+185 °F)	
Humidity		50...95% RH from 25...60 °C (77...140 °F)	

* Performance Data — see page Important-3 of the Industrial Controls catalog.

⊛ Momentary mushroom operators are IP65. Plastic keyed operators are IP66, Type 4/13; not Type 4X.

‡ Limit of four contact blocks max. for these devices.

§ Operating temperatures below 0 °C (32 °F) are based on the absence of freezing moisture and liquids, UL Recognized to 55 °C (131 °F) - Incandescent module max. 40 °C (104 °F).

Product Certifications

Certifications	UR/UL, CSA, CCC, CE
Standards Compliance — CE Marked	NEMA ICS-5; UL 508, EN ISO 13850, EN 60947-1, EN 60947-5-1, EN 60947-5-5
Terminal Identification	EN/IEC 60947-1
Shipping Approvals	ABS
RoHS	✓

Bulletin 800F
22.5 mm Push Buttons
Specifications

Back-of-Panel Components*

Electrical Ratings			
Standard contact block ratings	A600, Q600 600V AC AC 15, DC 13 to IEC/EN 60947-5-1 and UL 508, 17V, 5 mA min.		
Low voltage contact block ratings*	5V, 1 mA DC min. C300, R150, AC 15, DC 13 to EN 60947-5-1 and UL 508		
	Nominal Voltage	Range	Current Draw
LED Module Ratings	24...120V AC/DC	20...132V AC/DC	15 mA (AC), 12 mA (DC)
	24V AC	10...29V AC	31 mA
	24V DC	10...30V DC	24 mA
	120V AC	102...132V AC	6 mA
	240V AC	204...264V AC	6 mA
Frequency	50/60 Hz, DC		
Thermal current	10 A max. enclosed (40 °C ambient) to UL508, EN 60947-5-1		
Insulation voltage (U _i)	Screw terminal = 690V, spring-clamp = 300V		
Wire capacity (screw terminal)‡	#18...12 AWG (0.75...2.5 mm ²) Max. (2) #14 AWG or (1) #12 AWG		
Wire capacity (spring-clamp terminal)	#18...14 AWG (0.75...1.5 mm ²) One per spring clamp, two spring clamps per terminal		
Recommended tightening torque on screw terminals	0.7...0.9 N•m (6...8 lb•in)		
Dielectric strength (minimum)	2500V for one minute		
External short circuit protection	Standard blocks	10 A type gL/gG cartridge fuse to EN 60269-2-1 or gN (Class J to UL 248-8 or Class C to UL 248-4)	
	Low voltage contact blocks	6 A type gL/gG cartridge fuse to EN 60269-2-1 or gN (Class J to UL 248-8 or Class C to UL 248-4)	
Electrical shock protection	Finger-safe conforming to IP2X		
Mechanical Ratings			
Vibration (assembled to panel)	Tested at 10...2000 Hz, 1.52 mm displacement (peak-to-peak) max./10 G max. 6 hr		
Shock	Tested at 1/2 cycle sine wave for 11 ms and no damage at 100 G max.		
Contact durability per EN 60947-5-1 (Annex C)	10 000 000 cycles		
Contact operation	N.O.	Slow double make and break	
	N.C. & S.M.C.B.	Slow double make and break — positive opening ⊖	
	N.O.E.M.	Double break / double make, early make	
	N.C.L.B.	Double break / double make, late break — positive opening ⊖	
	N.C.E.B.	Double break / double make, early break — positive opening ⊖	
Push button travel to change electrical state	N.C. and N.O.E.M.	1.5 mm (0.060 in.)	
	N.O. and N.C.L.B.	2.5 mm (0.1 in.)	
Operating forces (typical)	Single circuit contact block	3.4 N	
	Dual circuit contact block	5...6.5 N	
Illumination			
LED Dominant Wavelength	Green	525 nm	
	Red	629 nm	
	Yellow	590 nm	
	Blue	470 nm	
	White	—	
LED Luminous Intensity	Green	780 mcd	
	Red	780 mcd	
	Yellow	600 mcd	
	Blue	168 mcd	
	White	360 mcd	
Incandescent maximum wattage	2.6 W		
Materials			
Springs	Stainless steel and zinc coated music wire		
Electrical contacts	Standard	Silver-nickel	
	Low voltage	Gold-plated over silver	
Terminals	Screw	Brass	
	Spring-clamp	Silver-plated brass	

* Performance Data — see page Important-3 of the Industrial Controls catalog.

* Low voltage contacts are recommended for applications below 17V, 5 mA.

‡ Wires less than #18 AWG (0.75 mm²) may not hold in terminal securely.



Material Listing

Component	For Use with	Material Used
Panel gasket	All operators	Nitrile, TPE
Diaphragm seal	Illuminated push button, non-illuminated push button	Automotive industry acceptable silicone
K-seal	Selector switch, key selector switch, push/twist-to-release E-stop, key E-stop, push/pull mushroom	Nitrile
Diaphragm retainer, return spring I	Illuminated push button, non-illuminated push button, momentary mushroom	Stainless steel
Return spring II	Reset, selector switch, key selector switch, alternate action, push/twist-to-release E-stop, key E-stop, push/pull mushroom	Zinc-coated music wire
Button cap/mushroom head	Non-illuminated push button, momentary mushroom, reset, push/twist-to-release E-stop, key E-stop, push/pull mushroom, multi-function	PBT/polycarbonate blend
2-color molded button cap	Non-illuminated push button	PBT/polycarbonate blend
Lens	Multi-function	Acetal
Lens, knob	Illuminated push button, illuminated momentary mushroom, illuminated selector switch	Polyamide
Knob	Non-illuminated selector switch	Glass-filled polyamide
Plastic bezel/bushing I	Non-illuminated push button, illuminated push button, momentary mushroom, selector switch, key selector switch, push/twist-to-release E-stop, key E-stop, push/pull mushroom, multi-function, reset	Glass-filled polyamide
Plastic bezel/bushing II, jam nut	Pilot light, reset jam nut, reset pushers	Glass-filled PBT
Metal bezel/bushing	All metal operators	Zinc
Diffuser	Illuminated push button, pilot light	Polycarbonate
Legend frames	—	Glass-filled polyamide
Plastic mounting ring	All plastic operators	Glass-filled polyamide
Metal mounting ring	All metal operators	Chromated zinc
Plastic latch	—	Glass-filled polyamide
Metal latch	—	Chromated zinc + stainless steel
Plastic enclosure	—	PBT/polycarbonate blend
Metal enclosure	—	Aluminum
Terminal screws	LED module, incandescent module, contact blocks	Zinc-plated steel with chromate
Terminals	LED module, incandescent module, contact blocks	Brass with silver-nickel contacts
Spring clamps	LED module, incandescent module, contact blocks	Stainless steel
Lamp socket	Incandescent module	Brass
Housing	Incandescent module, LED module	Glass-filled polyamide
Low-voltage terminals	Contact blocks	Gold-plated silver-nickel contacts
Low-voltage spanner	Contact blocks	Gold-plated silver-nickel contacts
Spanner	Contact blocks	Brass with silver-nickel contacts
Boot	Toggle Switch, illuminated push button, non-illuminated push button, multi-function illuminated and non-illuminated	Automotive industry acceptable silicone

22.5 mm Push Buttons

Quick Selection



Quick Selection Components

Operator Style	Description	Color	Construction	Pkg. Quantity	Cat. No.
 <p><i>Flush Operator</i> Cat. No. 800FP-F3</p>	Non-illuminated, flush push button	Black	Plastic	1	800FP-F2
	Non-illuminated, flush push button	Green			800FP-F3
	Non-illuminated, extended push button	Red			800FP-E4
	Non-illuminated, flush push button	Black	Metal		800FM-F2
	Non-illuminated, flush push button	Green			800FM-F3
	Non-illuminated, extended push button	Red			800FM-E4
 <p><i>Flush Operator</i> Cat. No. 800FM-LF4</p>	Illuminated, flush push button	Green	Plastic	1	800FP-LF3
	Illuminated, extended push button	Red			800FP-LE4
	Illuminated, flush push button	Yellow			800FP-LF5
	Illuminated, flush push button	Green	Metal		800FM-LF3
	Illuminated, extended push button	Red			800FM-LE4
	Illuminated, flush push button	Yellow			800FM-LF5
 <p><i>Diffused Pilot Light</i> Cat. No. 800FP-P7</p>	Diffused pilot light	Green	Plastic	1	800FP-P3
		Red			800FP-P4
		Yellow			800FP-P5
		Green	Metal		800FM-P3
		Red			800FM-P4
Yellow	800FM-P5				
 <p><i>Selector Switch</i> Cat. No. 800FP-SM32</p>	Non-illuminated, 2-position, maintained selector switch	Black	Plastic	1	800FP-SM22
	Non-illuminated, 3-position, maintained selector switch				800FP-SM32
	Non-illuminated, 3-position, spring return from both positions selector switch				800FP-SB32
	Non-illuminated, 2-position, maintained selector switch		Metal		800FM-SM22
	Non-illuminated, 3-position, maintained selector switch				800FM-SM32
	Non-illuminated, 3-position, spring return from both positions selector switch				800FM-SB32
 <p><i>40 mm Trigger Action Twist-to-Release Mushroom</i> Cat. No. 800FP-MT44</p>	Non-illuminated, 40 mm twist-to-release maintained mushroom (plastic)	Red	Plastic	1	800FP-MT44
	Non-illuminated, 40 mm push-pull maintained mushroom				800FP-MP44
	Non-illuminated, 40 mm twist-to-release maintained mushroom (metal)		Metal		800FM-MT44
	Non-illuminated, 40 mm push-pull maintained mushroom				800FM-MP44
Back of Panel	Description			Pkg. Quantity	Cat. No.
 <p><i>Power Module with Latch</i> Cat. No. 800F-MN3G</p>	Metal latch			10	800F-ALM
	Plastic latch				800F-ALP
	Normally open contact block				800F-X10
	Normally closed contact block				800F-X01
	Integrated LED module with plastic latch — Red LED			1	* 800F-PNxR
	Integrated LED module with plastic latch — Green LED				* 800F-PNxG
	Integrated LED module with plastic latch — White LED				* 800F-PNxW
	Integrated LED module with metal latch — Red LED				* 800F-MNxR
	Integrated LED module with metal latch — Green LED				* 800F-MNxG
	Integrated LED module with metal latch — White LED				* 800F-MNxW

* To complete the cat. no., replace the x with one of the following voltage codes: **3** = 24V, **5** = 120V, **7** = 240V.

Complete Devices*

Non-Illuminated Push Buttons, Momentary (Screw Terminal Connections)

	Description	Type of Contact		Color	Construction	Pkg. Quantity	Cat. No.
		N.O.	N.C.				
 Cat. No. 800FP-F3PX10	Flush	1	—	Green	Plastic operator/plastic latch	1	800FP-F3PX10
				Black			800FP-F2PX10
				Green	Metal operator/metal latch		800FM-F3MX10
				Black			800FM-F2MX10
 Cat. No. 800FM-E4MX01	Extended	—	1	Red	Plastic operator/plastic latch	1	800FP-E4PX01
					Metal operator/metal latch		800FM-E4MX01
 Cat. No. 800FP-U2E4F3PX10	Multi-function (Flush/extended)	1	1	Green/Red	Plastic operator/plastic latch	1	800FP-U2E4F3PX11
					Metal operator/metal latch		800FM-U2E4F3MX11
				Green "1" / Red "0"	Plastic operator/plastic latch		800FP-U2EFFEPX11
					Metal operator/metal latch		800FM-U2EFFEMX11

Non-Illuminated Selector Switches (Screw Terminal Connections)

	Description	Type of Contact		Style	Construction	Pkg. Quantity	Cat. No.
		N.O.	N.C.				
 Cat. No. 800FP-SM22PX10	Standard lever, black	1	—	2-position maintained	Plastic operator/plastic latch	1	800FP-SM22PX10
		1	1	2-position maintained	Plastic operator/plastic latch		800FP-SM22PX11
		1	—	2-position maintained	Metal operator/metal latch		800FM-SM22MX10
		1	1	2-position maintained	Metal operator/metal latch		800FM-SM22MX11
		2	—	3-position maintained	Plastic operator/plastic latch		800FP-SM32PX20
		2	—	3-position maintained	Metal operator/metal latch		800FM-SM32MX20

* For complete devices not listed and configuration assistance, see RAISE product selection software (<http://www.ab.com/raise>).

22.5 mm Push Buttons

Quick Selection

Complete Devices, Continued*

Non-Illuminated Emergency Stop Operators, Ø 40 mm, Red (Screw Terminal Connections)

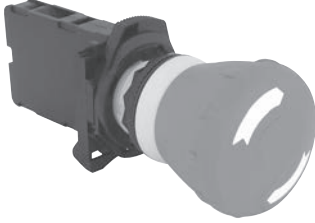
	Description	Type of Contact*		Construction	Pkg. Quantity	Cat. No.
		N.O.	N.C.			
 <p><i>Cat. No. 800FP-MT44PX01S</i></p>	Twist-to-Release	—	1	Plastic operator/plastic latch	1	800FP-MT44PX01S
		—	1	Metal operator/metal latch		800FM-MT44MX01S
		1	1	Plastic operator/plastic latch		800FP-MT44PX11S
		1	1	Metal operator/metal latch		800FM-MT44MX11S

* Self-monitoring contact block included when N.C. is specified.

Pilot Lights with Integrated LED Modules (Screw Terminal Connections)

	Voltage	Style	Construction	Pkg. Quantity	Cat. No.
 <p><i>Cat. No. 800FP-P7PN3W</i></p>	24V AC/DC	Green	Plastic operator/plastic latch	1	800FP-P3PN3G
		Red			800FP-P4PN3R
		Yellow			800FP-P5PN3Y
		Blue			800FP-P6PN3B
		White			800FP-P7PN3W
	120V AC	Green			800FP-P3PN5G
		Red			800FP-P4PN5R
		Yellow			800FP-P5PN5Y
		Blue			800FP-P6PN5B
		White			800FP-P7PN5W
	240V AC	Green			800FP-P3PN7G
		Red			800FP-P4PN7R
		Yellow			800FP-P5PN7Y
		Blue			800FP-P6PN7B
		White			800FP-P7PN7W

* For complete devices not listed and configuration assistance, see RAISE product selection software (<http://www.ab.com/raise>).

Momentary Push Button Operators, Non-Illuminated — Flush, Extended, Guarded



Flush Operator
 Cat. No. 800FP-F3



Extended Operator
 Cat. No. 800FM-E4



Guarded Operator
 Cat. No. 800FP-G6

Color	Pkg. Quantity	Flush		Extended	
		Plastic	Metal	Plastic	Metal
		Cat. No.	Cat. No.	Cat. No.	Cat. No.
Black	1	800FP-F2	800FM-F2	800FP-E2	800FM-E2
Green		800FP-F3	800FM-F3	800FP-E3	800FM-E3
Red		800FP-F4	800FM-F4	800FP-E4	800FM-E4

800F P - F 3 -
 a b c d

a

Operator Construction	
Code	Description
P	Round plastic operator (IP66, Type 4/4X/13)
M	Round metal operator (IP66, Type 4/13)

c

Color Cap	
Code	Color
0	Orange
1	White
2	Black
3	Green
4	Red
5	Yellow
6	Blue
8	Grey*
9	No cap
X	Assortment pack*

d

Packaging	
Code	Description
Blank	1 per package
BP	10 per package‡

b

Operator Type	
Code	Description
F	Flush
E	Extended
G	Guarded

* Available in flush only.
 * Assortment pack contains one cap of each color, not available in BP packaging.
 ‡ Only available with no color cap (9 from Table c).

22.5 mm Push Buttons

Product Selection

Momentary Push Button Operators, Non-Illuminated — with Two-Color Molded Legend Caps



Flush Operator
Cat. No. 800FP-F301

Button Color	Text Color	Legend Text	Pkg. Quantity	Flush		Extended	
				Plastic	Metal	Plastic	Metal
				Cat. No.	Cat. No.	Cat. No.	Cat. No.
Green	White	START	1	800FP-F301	800FM-F301	–	–
		I		800FP-F306	800FM-F306	–	–
Red	White	STOP		800FP-F402	800FM-F402	800FP-E402	800FM-E402
		O		–	–	800FP-E405	800FM-E405
Black	White	→		800FP-F208	800FM-F208	800FP-E208	800FM-E208

800F **P** – **F** **3** **01**

a *b* *c* *d*

a

Operator Construction	
Code	Description
P	Round plastic operator (IP66, Type 4/4X/13)
M	Round metal operator (IP66, Type 4/13)

b

Operator Type	
Code	Description
F	Flush
E	Extended
G	Guarded

c

Color Cap	
Code	Color
0	Orange
1	White
2	Black
3	Green
4	Red
5	Yellow
6	Blue

d

Legend Text**‡§	
Code	Text
Blank	No Text
01	START
02	STOP
05	O
06	I
08	→
09	Forward*
10	Reverse*
11	R

* For custom laser-engraved legend cap, order “no cap” option on page 10-73 plus custom laser-engraved cap on page 10-115.
 * White and yellow caps have black text. All other color caps have white text.
 § Legend button cap supplied loose for customer installation.
 * Available for flush only.
 ‡ Valid color cap/legend text codes include:

Color	Text	
	Flush Caps	Extended Caps
White	FORWARD, REVERSE, START, I, →, R	→, R
Black	FORWARD, REVERSE, →, R	STOP, O, →, R
Green	FORWARD, REVERSE, START, I, →	→
Red	FORWARD, REVERSE, STOP, O, →	STOP, O, →
Yellow	FORWARD, REVERSE, →	→
Blue	FORWARD, REVERSE, →, R	→, R

Momentary Push Button Operators, Illuminated — Flush, Extended, Guarded



Flush Operator
 Cat. No. 800FM-LF4



Extended Operator
 Cat. No. 800FP-LE3



Guarded Operator
 Cat. No. 800FP-LG3

Color	Pkg. Quantity	Flush		Extended	
		Plastic	Metal	Plastic	Metal
		Cat. No.	Cat. No.	Cat. No.	Cat. No.
Green	1	800FP-LF3	800FM-LF3	800FP-LE3	800FM-LE3
Red		800FP-LF4	800FM-LF4	800FP-LE4	800FM-LE4
Yellow		800FP-LF5	800FM-LF5	800FP-LE5	800FM-LE5
Clear		800FP-LF7	800FM-LF7	800FP-LE7	800FM-LE7

800F P - LE 3 -
 a b c d

a

Operator Construction	
Code	Description
P	Round plastic operator (IP66, Type 4/4X/13)
M	Round metal operator (IP66, Type 4/13)

c

Color Cap *	
Code	Color
0	Amber*
3	Green
4	Red
5	Yellow*
6	Blue*
7	Clear
9	No cap

d

Packaging	
Code	Description
Blank	1 per package
BP	10 per package†

b

Operator Type	
Code	Description
LF	Flush
LE	Extended
LG	Guarded

* For custom laser-engraved operator, order operator with applicable lens cap color plus custom laser-engraved diffuser; see page 10-115.
 * When using LED for illumination, a white LED is recommended.
 † Only available with no color cap (9 from Table c).

Push-to-Test Push Button Device Schematic

Illuminated push buttons may be wired as a push-to-test device by using the following schematic and Cat. No. 800F-XD7 Diode module from page 10-111.

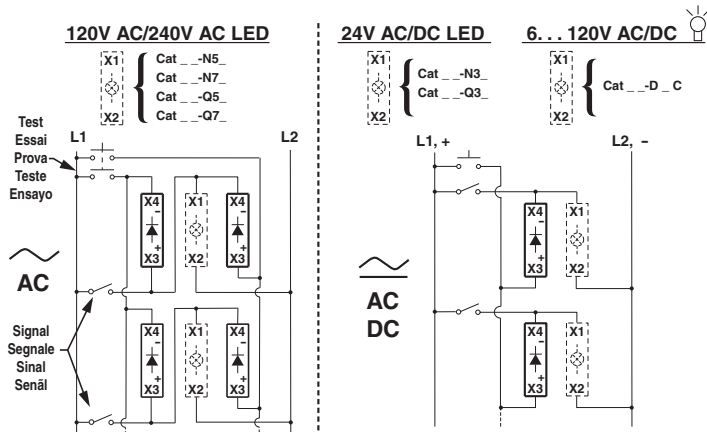

22.5 mm Push Buttons

Product Selection

Alternate Action Operators — Non-Illuminated



Cat. No. 800FM-FA3

800F M - FA 3
 a b c

a

Operator Construction	
Code	Description
P	Round plastic operator (IP66, Type 4/4X/13)
M	Round metal operator (IP66, Type 4/13)

b

Operator Type*	
Code	Description
FA	Non-illuminated, flush, alternate action

c

Color Cap*	
Code	Color
0	Orange
1	White
2	Black
3	Green
4	Red
5	Yellow
6	Blue
9	No cap
X	Assortment pack

* Must use N.O.E.M. or N.C. contacts.

⚙ For custom laser-engraved legend cap, order "no cap" option plus custom laser-engraved cap on page 10-115.

Alternate Action Operators — Illuminated



Cat. No. 800FP-LFA3

800F P - LFA 3
 a b c

a

Operator Construction	
Code	Description
P	Round plastic operator (IP66, Type 4/4X/13)
M	Round metal operator (IP66, Type 4/13)

b

Operator Type§*	
Code	Description
LFA	Illuminated, flush, alternate action

c

Color Cap>	
Code	Color
0	Amber⚙
3	Green
4	Red
5	Yellow⚙
6	Blue⚙
7	Clear
9	No lens

§ Must use N.O.E.M. or N.C. contacts.

♣ LED module required for illumination, can not use incandescent module.

> For custom laser-engraved operator, order operator with applicable lens cap color plus custom laser-engraved diffuser on page 10-115.

⚙ Use of a white LED is recommended.



Pilot Light Operators*



Plastic Pilot Light
 Cat. No. 800FP-P7



Metal Pilot Light
 Cat. No. 800FM-P4

Color	Pkg. Quantity	Plastic	Metal
		Cat. No.	Cat. No.
Green	1	800FP-P3	800FM-P3
Red		800FP-P4	800FM-P4
Yellow		800FP-P5	800FM-P5

800F P - P 3 -
 a b c d

a

Operator Construction	
Code	Description
P	Round plastic operator (IP66, Type 4/4X/13)
M	Round metal operator (IP66, Type 4/13)

c

Lens Cap*	
Code	Color
0	Amber*
3	Green
4	Red
5	Yellow*
6	Blue*
7	Clear
9	No lens

d

Packaging	
Code	Description
Blank	1 per package
BP	10 per package

b

Operator Type	
Code	Description
P	Diffuser

* For custom laser-engraved pilot light, order pilot light with applicable lens cap color plus custom laser-engraved diffuser on page 10-115.
 * When using LED for illumination, a white LED is recommended.

Bulletin 800F
22.5 mm Push Buttons
 Product Selection

2-Position Selector Switch Operators, Non-Illuminated



Standard Knob
 Cat. No. 800FP-SM22



Knob Lever
 Cat. No. 800FP-HM22

Switching Angle

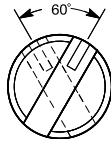

Target Table and Operator Position*

Contact Type§		
N.O.	O	X
N.C.	X	O

Note: X = Closed/O = Open

§ Contact selection is limited to the following options, consult your local Rockwell Automation sales office or Allen-Bradley distributor for other options.

Color	Operator Type 	Pkg. Quantity	Standard Knob	
			Plastic Cat. No.	Metal Cat. No.
Black with White Insert		1	800FP-SM22	800FM-SM22

* Target table for spring return from left is reversed from what is shown in the table.

800F **P** - **S** **M2** **2** - **e** - **f**

a *b* *c* *d* *e* *f*

a

Operator Construction	
Code	Description
P	Round plastic operator (IP66, Type 4/4X/13)
M	Round metal operator (IP66, Type 4/13)

b

Operator Type	
Code	Description
S	Standard knob
H	Knob lever*

c

Operator Function	
Code	Type
M2	Maintained (60° switching angle)
L2	Spring return from left (60° switching angle)
R2	Spring return from right (60° switching angle)

e

Orientation	
Code	Description
Blank	Standard
N	90° offset†

f

Packaging	
Code	Description
Blank	1 per package
BP	10 per package‡

d

Knob/Insert Color		
Code	Knob Color	Insert Color
2	Black	White

10 * 30 mm hole spacing will not work if knob lever is used. See page 10-125 for recommended operator panel spacing.
 † For use in vertical mount Bul. 800F enclosures.
 ‡ Not available with 90° offset orientation.

2-Position Selector Switch Operators, Illuminated §



Standard Knob
 Cat. No. 800FP-LSM26

Switching Angle



Target Table and Operator Position*		
Contact Type➤		
N.O.	O	X
N.C.	X	O

Note: X = Closed/O = Open

➤ Contact selection is limited to the following options, consult your local Rockwell Automation sales office or Allen-Bradley distributor for other options.

Color	Operator Type		Pkg. Quantity	Standard Knob	
				Plastic	Metal
				Cat. No.	Cat. No.
Green	∨		1	800FP-LSM23	800FM-LSM23
Red	∨			800FP-LSM24	800FM-LSM24
Yellow	∨			800FP-LSM25	800FM-LSM25

* Target table for spring return from left is reversed from what is shown in the table.

800F **P** - **LS** **M2** **3** _____
 a **b** **c** **d** **e**

a

Operator Construction	
Code	Description*
P	Round plastic operator (IP66, Type 4/4X/13)
M	Round metal operator (IP66, Type 4/13)

b

Operator Type	
Code	Description
LS	Standard knob
LH	Knob lever‡

c

Operator Function	
Code	Type
M2	Maintained (60° switching angle) ∨
L2	Spring return from left (60° switching angle)
R2	Spring return from right (60° switching angle)

d

Knob/Insert Color		
Code	Knob Color	Insert Color
0	Amber➤	White
3	Green	White
4	Red	White
5	Yellow➤	Black
6	Blue➤	White
7	Clear	Black

e

Orientation	
Code	Description
Blank	Standard
N	90° offset‡

* LED module required for illumination, can not use incandescent module.

‡ For use in vertical mount enclosures.

§ Crevices may exist on product that may be unsuitable for certain applications. Please consult your local Rockwell Automation sales office or Allen-Bradley distributor.

‡ Only available in clear.

➤ Use of a white LED is recommended.

3-Position Selector Switch Operators, Non-Illuminated



Standard Knob
 Cat. No. 800FP-SM32



Knob Lever
 Cat. No. 800FM-HM32

Switching Angle

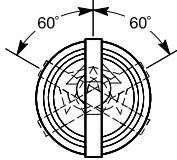

Target Table and Operator Position (60° Switching Angle)				
Contact Type*	Position on Mounting Latch			
N.O.	Left	X	O	O
	Right	O	O	X
	Center	X	O	X
	Center CL†	X	O	O
	Center CR†	O	O	X
N.C.	Left	O	X	X
	Right	X	X	O
	Center	O	X	O
	Center CL†	O	X	X
	Center CR†	X	X	O

Note: X = Closed/O = Open

* Contact selection is limited to the following options, consult your local Rockwell Automation sales office or Allen-Bradley distributor for other options.

Color	Operator Type		Pkg. Quantity	Standard Knob		Knob Lever	
				Plastic	Metal	Plastic	Metal
				Cat. No.	Cat. No.	Cat. No.	Cat. No.
Black with White Insert			1	800FP-SM32	800FM-SM32	800FP-HM32	800FM-HM32
				800FP-SB32	800FM-SB32	800FP-HB32	800FM-HB32

800F P - S M3 2
 a b c d e f

a

Operator Construction	
Code	Description
P	Round plastic operator (IP66, Type 4/4X/13)
M	Round metal operator (IP66, Type 4/13)

c

Operator Function	
Code	Type
M3	Maintained
L3	Spring return from left
R3	Spring return from right
B3	Spring return from left and right

d

Knob/Insert Color		
Code	Knob Color	Insert Color
2	Black	White

e

Orientation	
Code	Description
Blank	Standard
N	90° offset*

f

Operation	
Code	Description
Blank	Standard
CL	Center left†
CR	Center right†

b

Operator Type	
Code	Description
S	Standard knob
H	Knob lever*

* 30 mm hole spacing will not work if knob lever is used. See page 10-125 for recommended operator panel spacing.

* For use in vertical mount enclosures.

† The center contact block can have the same target output as the left or right contact block, by specifying center left (CL) or center right (CR) option.

3-Position Selector Switch Operators, Illuminated ‡



Standard Knob
 Cat. No. 800FP-LSM37

Switching Angle

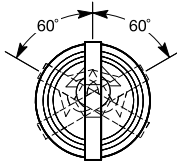

Target Table and Operator Position (60° Switching Angle)				
Contact Type*	Position on Mounting Latch			
N.O.	Left	X	O	O
	Right	O	O	X
N.C.	Left	O	X	X
	Right	X	X	O

Note: X = Closed/O = Open

* Contact selection is limited to the following options, consult your local Rockwell Automation sales office or Allen-Bradley distributor for other options.

Operator Type 	Pkg. Quantity	Green		Red		Yellow	
		Plastic	Metal	Plastic	Metal	Plastic	Metal
		Cat. No.	Cat. No.	Cat. No.	Cat. No.	Cat. No.	Cat. No.
	1	800FP-LSM33	800FM-LSM33	800FP-LSM34	800FM-LSM34	800FP-LSM35	800FM-LSM35
		800FP-LSR33	800FM-LSR33	800FP-LSR34	800FM-LSR34	800FP-LSR35	800FM-LSR35
		800FP-LSL33	800FM-LSL33	800FP-LSL34	800FM-LSL34	800FP-LSL35	800FM-LSL35
		800FP-LSB33	800FM-LSB33	800FP-LSB34	800FM-LSB34	800FP-LSB35	800FM-LSB35

800F P - LS M3 3 e

a b c d e

a

Operator Construction	
Code	Description*
P	Round plastic operator (IP66, Type 4/4X/13)
M	Round metal operator (IP66, Type 4/13)

b

Operator Type	
Code	Description
LS	Standard knob
LH	Knob lever§

c

Operator Function	
Code	Type
M3	Maintained
L3	Spring return from left
R3	Spring return from right
B3	Spring return from left and right

d

Knob/Insert Color		
Code	Knob Color	Insert Color
0	Amber➤	White
3	Green	White
4	Red	White
5	Yellow➤	Black
6	Blue➤	White
7	Clear	Black

e

Orientation	
Code	Description
Blank	Standard
N	90° offset*

* LED module required for illumination, can not use incandescent module.

➤ For use in vertical mount 800F enclosures.

‡ Crevices may exist on product that may be unsuitable for certain applications. Please consult your local Rockwell Automation sales office or Allen-Bradley distributor.

§ Only available in clear.

➤ Use of a white LED is recommended.

22.5 mm Push Buttons

Product Selection

4-Position Selector Switch Operators, Non-Illuminated



Standard Knob
Cat. No. 800FP-SM42

Target Table and Operator Position*					
Contact Type§	Position on Mounting Latch				
N.O.	Left	O	O	X	O
	Right	X	O	O	O
	Center	X	O	X	O
	Center CL	O	O	X	O
	Center CR	X	O	O	O
N.C.E.B.	Left	O	O	O	X
	Right	O	X	O	O
	Center CL	O	O	O	X
	Center CR	O	X	O	O
N.C.L.B.	Left	X	X	O	X
	Right	O	X	X	X
	Center	O	X	O	X
	Center CL	X	X	O	X
	Center CR	O	X	X	X

Note: X = Closed/O = Open

§ Contact selection is limited to the following options, consult your local Rockwell Automation sales office or Allen-Bradley distributor for other options.

Color	Standard Knob — Maintained		Pkg. Quantity
	Plastic	Metal	
	Cat. No.	Cat. No.	
Black with White Insert	800FP-SM42	800FM-SM42	1

800F **P** - **S** **M4** **2** **e** **f**

a *b* *c* *d* *e* *f*

a

Operator Construction	
Code	Description
P	Round plastic operator (IP66, Type 4/4X/13)
M	Round metal operator (IP66, Type 4/13)

c

Operator Function	
Code	Type
M4	Maintained (45° switching angle)

e

Orientation	
Code	Description
Blank	Standard
N	90° offset*

b

Operator Type	
Code	Description
S	Standard knob
H	Knob lever

d

Knob/Insert Color		
Code	Knob Color	Insert Color
2	Black	White

f

Operation	
Code	Description
Blank	Standard
CL	Center left‡
CR	Center right‡

* Must use N.O., N.C.E.B., or N.C.L.B. contact blocks only. Cannot use N.C. or N.O.E.M. contact blocks with 4-position selector switch.

‡ For use in vertical mount enclosures.

‡ The center contact block can have the same target output as the left or right contact block, by specifying center left (CL) or center right (CR) option.



2-Position Key-Operated Selector Switches, Non-Illuminated



Key Selector Switch
 Cat. No. 800FP-KM21R

Switching Angle



Target Table and Operator Position*		
Contact Type>		
N.O.	O	X
N.C.	X	O

Note: X = Closed/O = Open

> Contact selection is limited to the following options, consult your local Rockwell Automation sales office or Allen-Bradley distributor for other options.

Key Removal Position	Operator Type		Pkg. Quantity	Key Selector Switch Operators	
				Plastic	Metal
				Cat. No.	Cat. No.
Left			1	800FP-KM21	800FM-KM21
Both				800FP-KM23	800FM-KM23

* Target table for spring return from left is reversed from what is shown in the table.

800F **M** - **KM2** **1** **_____**
 a **b** **c** **d**

a

Operator Construction	
Code	Description
P	Round plastic operator (IP66, Type 4/13)
M	Round metal operator (IP66, Type 4/13)

b

Operator Type	
Code	Type
KM2	Maintained (60° switching angle)
KL2	Spring return from left (60° switching angle)
KR2	Spring return from right (60° switching angle)

c

Key Removal Position*	
Code	Position
1	Left
2	Right
3	Both

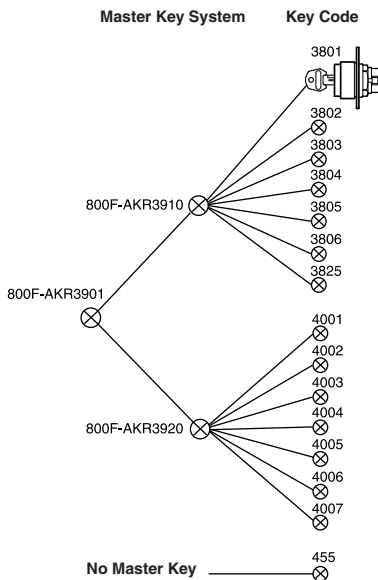

d

Ronis Key Lock†§*	
Code	Key No.
Blank	3825 (Standard)
R	455
01R	3801
02R	3802
03R	3803
04R	3804
05R	3805
06R	3806
27R	4001
28R	4002
29R	4003
30R	4004
31R	4005
32R	4006
33R	4007

* Key removal in maintained positions only.

† Keyed operators are IP66, Type 4/13.

§ Not intended for high security applications. Interoperability is possible with certain key/cylinder lock combinations. Consult your local Rockwell Automation sales office or Allen-Bradley distributor for interoperability information.

* For replacement Ronis keys, see Accessories, page 10-111.

22.5 mm Push Buttons

Product Selection

3-Position Key-Operated Selector Switches, Non-Illuminated



Key-Operated Selector Switch
Cat. No. 800FP-KM31R



Key-Operated Selector Switch
Cat. No. 800FM-KM31R

Switching Angle

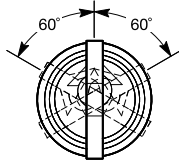

Target Table and Operator Position

Contact Type➤	Position on Mounting Latch			
		N.O.	Left	X
	Right	O	O	X
	Center	X	O	X
N.C.	Left	O	X	X
	Right	X	X	O
	Center	O	X	O

Note: X = Closed/O = Open

➤ Contact selection is limited to the following options, consult your local Rockwell Automation sales office or Allen-Bradley distributor for other options.

Key Removal Position	Operator Position			Pkg. Quantity	Key Selector Switch Operators	
					Plastic	Metal
					Cat. No.	Cat. No.
Left				1	800FP-KM31	800FM-KM31
All					800FP-KM33	800FM-KM33
Center					800FP-KM34	800FM-KM34
Center					800FP-KB34	800FM-KB34

800F M - KM3 3

a b c d

a

Operator Construction	
Code	Description
P	Round plastic operator (IP66, Type 4/13)
M	Round metal operator (IP66, Type 4/13)

b

Operator Type	
Code	Description
KM3	Maintained
KR3	Spring return from right
KL3	Spring return from left
KB3	Spring return from both

c

Key Removal Position*	
Code	Type
1	Left
3	All
4	Center
5	Left/center
7♣	Center/right

d

See page 10-83 for optional key codes*‡§

* Key removal in maintained positions only.

⊛ Keyed operators are IP66, Type 4/13.

‡ Not intended for high security applications. Interoperability is possible with certain key/cylinder lock combinations. Consult your local Rockwell Automation sales office or Allen-Bradley distributor for interoperability information.

§ For replacement Ronis keys, see Accessories, page 10-111.

♣ Key removal position only valid with operator types 800F_-KM3 and 800F_-KL3.

Emergency Stop Operators*

Non-Illuminated Twist-to-Release, Push-Pull



60 mm Non-Illuminated Twist-to-Release
 Cat. No. 800FP-MT64



40 mm Non-Illuminated Push-Pull
 Cat. No. 800FP-MP44

Color	Size	Pkg. Quantity	Twist-to-Release (Trigger Action)		Push-Pull (Trigger Action)	
			Plastic	Metal	Plastic	Metal
			Cat. No.	Cat. No.	Cat. No.	Cat. No.
Red	30	1	800FP-MT34	800FM-MT34	—	—
	40		800FP-MT44	800FM-MT44	800FP-MP44	800FM-MP44
	60		800FP-MT64	800FM-MT64	—	—

Illuminated — Twist-to-Release, Push-Pull‡



40 mm Illuminated Twist-to-Release
 Cat. No. 800FP-LMT44



40 mm Mushroom Push/Pull
 Cat. No. 800FM-LMP44

Color	Size	Pkg. Quantity	Twist-to-Release (Trigger Action)		Push-Pull (Trigger Action)	
			Plastic	Metal	Plastic	Metal
			Cat. No.	Cat. No.	Cat. No.	Cat. No.
Red	30	1	—	—	800FP-LMP34	800FM-LMP34
	40		800FP-LMT44	800FM-LMT44	800FP-LMP44	800FM-LMP44
	60		800FP-LMT64	800FM-LMT64	800FP-LMP64	800FM-LMP64

Key Release Mushroom Operator



40 mm Non-Illuminated Key Release
 Cat. No. 800FP-MK44

Color	Size	Pkg. Quantity	Ronis Key Lock (Trigger Action)*	
			Plastic	Metal
			Cat. No.	Cat. No.
Red	40 mm	1	800FP-MK44	800FM-MK44

* All emergency stop operators are EN ISO 13850 compliant with standard NC, NCLB, or self-monitoring contact blocks.

‡ LED module required for illumination, can not use incandescent module.

* For key options, see page 10-88.

22.5 mm Push Buttons

Product Selection

2-Position Push-Pull Operators, Non-Illuminated — Twist-to-Release (Trigger Action), Push-Pull (Trigger Action)*‡



40 mm Trigger Action
Twist-to-Release Mushroom
Cat. No. **800FP-MT44**



40 mm Trigger Action
Push-Pull Mushroom
Cat. No. **800FP-MP44**

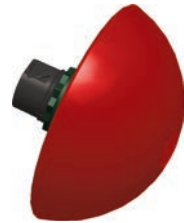

90 mm Half-Dome
Cat. No. **800FP-MP94**

Color	Pkg. Quantity	40 mm Mushroom (Trigger Action) Twist-to-Release		40 mm Mushroom (Trigger Action) Push-Pull	
		Plastic	Metal	Plastic	Metal
		Cat. No.	Cat. No.	Cat. No.	Cat. No.
Red	1	800FP-MT44	800FM-MT44	800FP-MP44	800FM-MP44

800F **P** - **MT4** **4**

a b c d

a

Operator Construction	
Code	Description
P	Round plastic operator (IP66, Type 4/4X/13)
M	Round metal operator (IP66, Type 4/13)

b

Operator Type	
Push, Twist-to-Release➤	
Code	Type
MT3	30 mm color cap
MT4	40 mm color cap
MT6	60 mm color cap
Push-Pull⊕	
Code	Type
MP4	40 mm color cap
Half-Dome Push-Pull⊕	
Code	Type
MP9	90 mm color cap⊛

c

Color Cap	
Code	Color
2	Black
3	Green
4	Red
5	Yellow
6	Blue

d‡§⊛

Engraving	
Code	Description
Blank	No engraving on cap
LE	EMO laser engraved
E	EMO printed

- * All emergency stop operators are EN ISO 13850 compliant with standard NC, NCLB, or self-monitoring contact blocks.
- ‡ E-Stop operators, latch, and contact block combinations have been third-party tested for B10d values. B10d values can be found in publication SAFETY-SR001_EN-E.
- Only available with red color cap.
- ⊕ For EMO guards, see page 10-109.
- § Only available on 40 mm color cap.
- ⊛ Only available on red, 40 mm push, twist-to-release operator type (MT44).
- ⊛ Half-dome operators only available with black, red, and yellow color caps.
- ⊕ Limit of four contact blocks max. for these devices.

2-Position Push-Pull Operators, Illuminated — Twist-to-Release (Trigger Action), Push-Pull (Trigger Action)*⊕



40 mm Illuminated Twist-to-Release
 Cat. No. 800FP-LMT44



40 mm Mushroom Push/Pull
 Cat. No. 800FM-LMP44

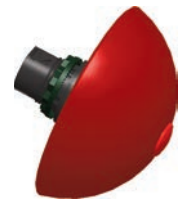

90 mm Half-Dome
 Cat. No. 800FP-LMP94

Color	Pkg. Quantity	40 mm Mushroom (Trigger Action) Twist-to-Release		40 mm Mushroom (Trigger Action) Push-Pull	
		Plastic	Metal	Plastic	Metal
		Cat. No.	Cat. No.	Cat. No.	Cat. No.
Red	1	800FP-LMT44	800FM-LMT44	800FP-LMP44	800FM-LMP44

800F P -LMP4 3
 a b c

a

Operator Construction	
Code	Description
P	Round plastic operator (IP66, Type 4/4X/13)
M	Round metal operator (IP66, Type 4/13)

b

Operator Type	
Push, Twist-to-Release†§	
Code	Type
LMT4	40 mm color cap
LMT6	60 mm color cap
Push-Pull⊕	
Code	Type
LMP3	30 mm color cap
LMP4	40 mm color cap
LMP6	60 mm color cap
Half-Dome Push-Pull⊕	
Code	Type
LMP9	90 mm color cap⊗

c

Lens Cap Color	
Code	Color
3	Green
4	Red
5	Yellow➤
6	Blue♣

- * LED module required for illumination, can not use incandescent module.
- ⊗ All emergency stop operators are EN ISO 13850 compliant with standard NC, NCLB, or self-monitoring contact blocks.
- ⊕ E-Stop operators, latch, and contact block combinations have been third-party tested for B10d values. B10d values can be found in publication SAFETY-SR001_-EN-E.
- † Only available with red color cap.
- § 60 mm version has black arrows; 30 and 40 mm versions have white arrows.
- Use of a white LED is recommended.
- ♣ Only available with 40 mm Push-Pull color cap (**LMP4** from Table b).
- ⊗ Half-dome operators only available with red and yellow lens cap colors.
- ⊕ Limit of four contact blocks max. for these devices.

22.5 mm Push Buttons

Product Selection

2-Position Non-Illuminated Operators — Mushroom, Key Release (Trigger Action)*♣



40 mm Key Release Mushroom
Cat. No. 800FP-MK44

Color	Pkg. Quantity	2-Position (Trigger Action) 40 mm Mushroom Key Release	
		Plastic	Metal
Red	1	Cat. No. 800FP-MK44	Cat. No. 800FM-MK44

Note: For replacement Ronis keys, see Accessories, page 10-111. Key release mushroom operators use key no. 3825.

800F P - MK4 4

a b c d

a

Operator Construction	
Code	Description
P	Round plastic operator (IP66, Type 4/13)
M	Round metal operator (IP66, Type 4/13)

b

Operator Type	
Key Release Mushroom	
Code	Type
MK4	40 mm

c

Lens Cap Color	
Code	Color
4	Red

d

Ronis Key Lock*‡§	
Code	Key No.
Blank	3825 (Standard)
R	455
01R	3801
02R	3802
03R	3803
04R	3804
05R	3805
06R	3806
27R	4001
28R	4002
29R	4003
30R	4004
31R	4005
32R	4006
33R	4007

- * All emergency stop operators are EN ISO 13850 compliant with standard NC, NCLB, or self-monitoring contact blocks.
- ♣ E-Stop operators, latch, and contact block combinations have been third-party tested for B10d values. B10d values can be found in publication SAFETY-SR001_-EN-E.
- ⚙ Keyed operators are IP66, Type 4/13.
- ‡ Not intended for high security applications. Interoperability is possible with certain key/cylinder lock combinations. Consult your local Rockwell Automation sales office or Allen-Bradley distributor for interoperability information.
- § For replacement Ronis keys, see Accessories, page 10-111.

3-Position Push-Pull Operators, Illuminated & Non-Illuminated — Mushroom*



Illuminated 3-Position Push-Pull
 Cat. No. 800FM-LMP44E3

Target Table and Operator Position*			
Contact Type†			
	Out	Center	In
N.O.	O	O	X
N.C.E.B.	X	O	O
N.C.L.B.	X	X	O

Note: X = Closed/O = Open

† Contact selection is limited to the following options, consult your local Rockwell Automation sales office or Allen-Bradley distributor for other options.

Operator Function	Operator Type	Color	Pkg. Quantity	Cat. No.
Momentary Out, Maintained Center, Momentary In	Non-Illuminated	Black§	1	800FM-MM42E3
		Green		800FM-MM43E3
		Red➤		800FM-MM44E3
	Illuminated*	Amber‡		800FM-LMM40E3
		Green		800FM-LMM43E3
		Red		800FM-LMM44E3
		Blue‡		800FM-LMM46E3
		Clear‡		800FM-LMM47E3
Momentary Out, Maintained Center, Maintained In	Non-Illuminated	Black§	1	800FM-MP42E3
		Green		800FM-MP43E3
		Red➤		800FM-MP44E3
	Illuminated*	Amber‡		800FM-LMP40E3
		Green		800FM-LMP43E3
		Red		800FM-LMP44E3
		Blue‡		800FM-LMP46E3
		Clear‡		800FM-LMP47E3

800F **M** - **L** **MM** **4** **4** **E3**
 a **b** **c** **d** **e** **f**

a

Operator Construction	
Code	Description
M	Round metal operator (IP66, Type 4/13)

b

Operator Type	
Code	Description
Blank	Non-illuminated
L	Illuminated*

c

Operator Function	
Code	Description
MM	Momentary out, Maintained center, Momentary in
MP	Momentary out, Maintained center, Maintained in

d

Cap Size	
Code	Description
4	40 mm plastic

e

Cap Color	
Code	Description
0	Amber‡%
2	Black§
3	Green
4	Red
6	Blue‡%
7	Clear‡%

f

Positions	
Code	Description
E3	3-position

- ‡ Sold as stand-alone operator only. Not available as a composite catalog number.
- * Must use N.O., N.C.E.B., or N.C.L.B. contact blocks only. Cannot use N.C. or N.O.E.M. contact blocks with 3-position push-pull operators.
- ‡ LED module required for illumination. Cannot use incandescent module.
- ‡ Available in illuminated only.
- % Use of white LED is recommended.
- § Available in non-illuminated only.
- Replacement caps are available for this device. Order Cat. No. 800F-AMP4.

22.5 mm Push Buttons

Product Selection

Momentary Push Button Operators, Non-Illuminated — Mushroom*



40 mm Mushroom
Cat. No. 800FM-MM42



60 mm Mushroom
Cat. No. 800FP-MM63



90 mm Mushroom
Cat. No. 800FP-MM94

Color	Pkg. Quantity	40 mm Mushroom		60 mm Mushroom	
		Plastic	Metal	Plastic	Metal
		Cat. No.	Cat. No.	Cat. No.	Cat. No.
Black	1	800FP-MM42	800FM-MM42	800FP-MM62	800FM-MM62
Green		800FP-MM43	800FM-MM43	800FP-MM63	800FM-MM63
Red		800FP-MM44	800FM-MM44	800FP-MM64	800FM-MM64
Yellow		800FP-MM45	800FM-MM45	800FP-MM65	800FM-MM65
Blue		800FP-MM46	800FM-MM46	800FP-MM66	800FM-MM66

800F **P** **-** **MM4** **3**
a *b* *c*

a

Operator Construction	
Code	Description
P	Round plastic operator (IP65, Type 4/4X/13)
M	Round metal operator (IP65, Type 4/13)

b

Size and Operator Type	
Code	Type
MM4	40 mm momentary
MM6	60 mm momentary
MM9	90 mm momentary*

c

Color Cap	
Code	Color
2	Black
3	Green
4	Red
5	Yellow
6	Blue

* Momentary mushroom operators are IP65 rated.
 * Only available with black, red, and yellow cap colors.

Momentary Push Button Operators, Illuminated — Mushroom*



40 mm Mushroom
 Cat. No. 800FP-LMM43

Color	Pkg. Quantity	40 mm Mushroom	
		Plastic Cat. No.	Metal Cat. No.
Green	1	800FP-LMM43	800FM-LMM43
Red		800FP-LMM44	800FM-LMM44
Yellow		800FP-LMM45	800FM-LMM45
Blue		800FP-LMM46	800FM-LMM46
Clear		800FP-LMM47	800FM-LMM47

800F **P** **-** **LMM4** **3**
 a *b* *c*

a

Operator Construction	
Code	Description
P	Round plastic operator (IP65, Type 4/4X/13)
M	Round metal operator (IP65, Type 4/13)

b

Size and Operator Type	
Code	Type
LMM4	40 mm momentary

c

Lens Cap Color	
Code	Color
3	Green
4	Red
5	Yellow*
6	Blue*
7	Clear*

* Momentary mushroom operators are IP65 rated.
 * When using LED for illumination, a white LED is recommended.

22.5 mm Push Buttons

Product Selection

2-Function Momentary Multi-Operator, Non-Illuminated



2-Function Momentary Multi-Operator Non-Illuminated
Cat. No. 800FP-U2E4F3

Position A			Position C			Pkg. Quantity	Plastic
Color	Type	Text	Color	Type	Text		Cat. No.
Red	Extended	Blank	Green	Flush	Blank	1	800FP-U2E4F3
		O			I		800FP-U2EFFE
		STOP			START		800FP-U2EBFA

800F P – U2 E 4 F 3 (with button caps)
a b c d e f

800F P – U2 X (without button caps)
a b c

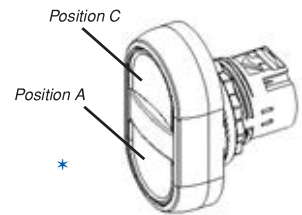

a

Operator Construction	
Code	Description
P	Plastic operator (IP66, Type 4/4X)
M	Metal operator (IP66, Type 4)

b

Operator Type	
Code	Description
U2	Two-function

c

Operator Type — Position A*	
Code	Description
F	Flush
E	Extended
X	No caps (all positions)*

d

Operator Color Cap/Text — Position A†	
Code	Description
1	White
2	Black
3	Green
4	Red
5	Yellow
6	Blue
A	Green with "Start" text
B	Red with "Stop" text
C	White with "Start" text
D	Black with "Stop" text
E	Green with "I" text
F	Red with "O" text
G	White with "I" text
H	Black with "O" text

f

Operator Color Cap/Text — Position C‡	
Code	Description
1	White
2	Black
3	Green
4	Red
5	Yellow
6	Blue
A	Green with "Start" text
B	Red with "Stop" text
C	White with "Start" text
D	Black with "Stop" text
E	Green with "I" text
F	Red with "O" text
G	White with "I" text
H	Black with "O" text

e

Operator Type — Position C*	
Code	Description
F	Flush
E	Extended

* Position 1 of the latch (left position when viewed from the back) corresponds to position A of the operator. Position 2 of the latch (right position when viewed from the back) corresponds to position C of the operator.

* For custom-engraved caps, order "no caps" option plus custom engraved caps on page 10-115.

‡ Valid color cap/legend text codes include:

Color	Text	
	Flush Caps	Extended Caps
White	START, I	—
Black	—	STOP, O
Green	START, I	—
Red	—	STOP, O



2-Function Momentary Multi-Operator, Illuminated*



2-Function Momentary Multi-Operator Illuminated
 Cat. No. 800FP-LU2E2E1

Position A			Position B	Position C			Pkg. Quantity	Plastic
Color	Type	Text	Type	Color	Type	Text		Cat. No.
Red	Extended	Blank	White Pilot Light	Green	Flush	Blank	1	800FP-LU2E4F3
		O				I		800FP-LU2EFFE
		STOP				START		800FP-LU2EBFA

800F P - LU2 E 4 F 3 (with button caps)
 a b c d e f

800F P - LU2 X (without button caps)
 a b c

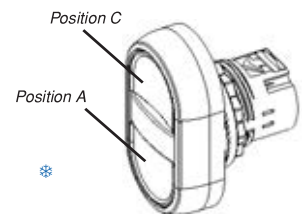

a

Operator Construction	
Code	Description
P	Plastic operator (IP66, Type 4/4X)
M	Metal operator (IP66, Type 4)

b

Operator Type*	
Code	Description
LU2	Two-function Illuminated

c

Operator Type — Position A*	
Code	Description
F	Flush
E	Extended
X	No caps (all positions)‡

d

Operator Color Cap/Text — Position A§	
Code	Description
1	White
2	Black
3	Green
4	Red
5	Yellow
6	Blue
A	Green with "Start" text
B	Red with "Stop" text
C	White with "Start" text
D	Black with "Stop" text
E	Green with "I" text
F	Red with "O" text
G	White with "I" text
H	Black with "O" text

f

Operator Color Cap/Text — Position C§	
Code	Description
1	White
2	Black
3	Green
4	Red
5	Yellow
6	Blue
A	Green with "Start" text
B	Red with "Stop" text
C	White with "Start" text
D	Black with "Stop" text
E	Green with "I" text
F	Red with "O" text
G	White with "I" text
H	Black with "O" text

e

Operator Type — Position C*	
Code	Description
F	Flush
E	Extended

* LED module required for illumination, can not use incandescent module.
 * Position 1 of the latch (left position when viewed from the back) corresponds to position A of the operator. Position 2 of the latch (right position when viewed from the back) corresponds to position C of the operator. Position 3 of the latch (center position) is reserved for the power module.
 ‡ For custom-engraved caps, order "no caps" option plus custom engraved caps on page 10-115.
 § Valid color cap/legend text codes include:

Color	Text	
	Flush Caps	Extended Caps
White	START, I	—
Black	—	STOP, O
Green	START, I	—
Red	—	STOP, O

22.5 mm Push Buttons

Product Selection

3-Function Momentary Multi-Operator, Non-Illuminated



3-Function Momentary Multi-Operator Non-Illuminated
Cat. No. 800FP-U3E4F34

Position A			Position B			Position C			Pkg. Quantity	Plastic
Color	Type	Text	Color	Type	Text	Color	Type	Text		Cat. No.
Green	Flush	Blank	Red	Extended	Blank	Green	Flush	Blank	1	800FP-U3F3F34

800F P – U3 E 4 F 3 4 (with button caps)
a b c d e f g

800F P – U3 X (without button caps)
a b c
a

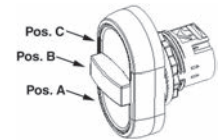

Operator Construction

Code	Description
P	Plastic operator (IP66, Type 4/4X)
M	Metal operator (IP66, Type 4)

Operator Type

Code	Description
U3	Three-function

Operator Type — Position A*

Code	Description
F	Flush
E	Extended
X	No caps (all positions)*‡

Operator Color Cap/Text — Position A§

Code	Description
1	White
2	Black
3	Green
4	Red
5	Yellow
6	Blue

Operator Color Cap/Text — Position A§

Code	Description
A	Green with "Start" text
B	Red with "Stop" text
C	White with "Start" text
D	Black with "Stop" text
E	Green with "I" text
F	Red with "O" text
G	White with "I" text
H	Black with "O" text

Operator Type — Position C*

Code	Description
F	Flush
E	Extended

Operator Color Cap/Text — Position C§

Code	Description
1	White
2	Black
3	Green
4	Red
5	Yellow
6	Blue

Operator Color Cap/Text — Position C§

Code	Description
A	Green with "Start" text
B	Red with "Stop" text
C	White with "Start" text
D	Black with "Stop" text
E	Green with "I" text
F	Red with "O" text
G	White with "I" text
H	Black with "O" text

Operator Color Cap/Text — Position B*‡

Code	Description
4	Red
B	Red with "Stop" text
F	Red with "O" text

* Position 1 of the latch (left position when viewed from the back) corresponds to position A of the operator. Position 2 of the latch (right position when viewed from the back) corresponds to position C of the operator. Position 3 of the latch (center position) corresponds to position B of the operator.

‡ For custom-engraved caps, order "no caps" option plus custom engraved caps on page 10-115.

‡ For "no caps" option, (position B) center cap available as red, no text only.

§ Valid color cap/legend text codes include:

Color	Text	
	Flush Caps	Extended Caps
White	START, I	—
Black	—	STOP, O
Green	START, I	—
Red	—	STOP, O

Reset Operators — Mechanical and/or Electrical Reset



Reset Operator
 Cat. No. 800FP-R611

Button Color	Legend Text	Pkg. Quantity	Flush — Round	
			Plastic	Metal
Blue	R	1	Cat. No.	Cat. No.
	No Legend		800FP-R611	800FM-R611
			800FP-R6	800FM-R6

800F M - R 6 11
 a b c d

a

Operator Construction	
Code	Description
P	Round plastic operator (IP66, Type 4/4X/13)
M	Round metal operator (IP66, Type 4/13)

b

Operator Type	
Code	Type
R	Reset*⊛

c

Color Cap	
Code	Color
1	White
2	Black
6	Blue

* Will accept latch and up to four single circuit contact blocks or two dual circuit contact blocks; no contacts allowed in center position.
 ⊛ 11 mm reset stroke length.

d

Legend Text	
Code	Text
Blank	No text
11	R

Threaded Reset Rod Reset Operators



Threaded Reset Rod with 35 mm Pusher
 Cat. No. 800F-ATR19L

Rod Length [mm]‡	Rod Length Adjustability [mm]	Pkg. Quantity	Threaded Reset Rod	
			10 mm Pusher	35 mm Pusher
			Cat. No.	Cat. No.
40	34...52	1	800F-ATR01	800F-ATR01L
55	50...67		800F-ATR02	800F-ATR02L
85	80...98		800F-ATR04	800F-ATR04L
115	110...128		800F-ATR06	800F-ATR06L
145	141...159		800F-ATR08	800F-ATR08L
315	34...326		§ 800F-ATR19	§ 800F-ATR19L

‡ If contact blocks are used, they must have a minimum rod length of 55 mm for one level of contact blocks and 85 mm for two levels of contact blocks.
 § Rod is threaded along its entire length for ease of cutting to desired length.

Bulletin 800F
22.5 mm Push Buttons
 Product Selection

Single Turn Potentiometer Assembly*†§



Series B



Series A

Resistive Element	Series B Cat. No.	Series A Cat. No.*
None (Operator Only)*	800FP-POT	800FP-POTA
150 Ω	800FP-POT1	800FP-POT1A
500 Ω	800FP-POT2	800FP-POT2A
1000 Ω	800FP-POT3	800FP-POT3A
2500 Ω	800FP-POT4	800FP-POT4A
5000 Ω	800FP-POT5	800FP-POT5A
10000 Ω	800FP-POT6	800FP-POT6A

* The Cat. No. 800FP-POT is a complete operator assembly supplied without the resistive element, used with potentiometers having a shaft diameter of 6.0 mm (0.23 in.) and a shaft length of 50.0 mm (1.97 in.), or a shaft diameter of 6.4 mm (0.25 in.) and a shaft length of 22.5 mm (0.88 in.). This operator is used with Type "J" potentiometers only.

⊛ Rated 300V AC/DC, 2 W max.

† A latch is not needed.

§ Additional hole spacing required for potentiometers. See page 10-125 for panel hole spacing requirements.

♣ Not stocked. Longer lead-time.

Key Operated Selector Switch - SensEject™

Patented Spring-Loaded Key Ejection System



2-Position
Switching Angle

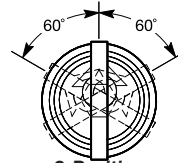

3-Position
Switching Angle

Operator Construction	Operator Type	Key Eject Position	Key Option§	Spare Keys	Contact Blocks	Cat. No. >
Round Metal Operator — SensEject is IP6X (dust-tight) Type 1	2-Position Maintained		Zadi Key 06Z	800F-AKE006	None	800FM-KEM2106Z
					1 N.O.; 1 N.C.	800FM-KEM2106ZMX11
	3-Position Spring Return from Both		Zadi Key 01Z	800F-AKE001	None	800FM-KEB3401Z
					2 N.O.; 3 N.C.	800FM-KEB3401ZMX23

§ Not intended for high security applications. Interoperability is possible with certain key/cylinder lock combinations. Consult your local Rockwell Automation sales office or Allen-Bradley distributor for interoperability information.

> Includes latch and spacer block.

Selector Push Button Operators*



Selector Jog Operator
 Cat. No. 800FM-SJ23

Target Table and Operator Position (2-Position)

Contact Type*	Position on Mounting Latch	↙		↘	
		Selector Left Free	Selector Left Depressed	Selector Right Free	Selector Right Depressed
N.O.	Left	O	X	O	O
N.O.	Right	O	O	O	X
N.O.	Center	O	X	O	X
N.C.	Left	X	O	X	X
N.C.	Right	X	X	X	O
N.C.	Center	X	O	X	O

Note: X = Closed/O = Open

Target Table and Operator Position (3-Position)

Contact Type*	Position on Mounting Latch	↙		↑		↘	
		Selector Left Free	Selector Left Depressed	Selector Center Free	Selector Center Depressed	Selector Right Free	Selector Right Depressed
N.O.	Left	O	X	O	X	O	O
N.O.	Right	O	O	O	X	O	X
N.O.	Center	O	X	O	X	O	X
N.C.	Left	X	O	X	O	X	X
N.C.	Right	X	X	X	O	X	O
N.C.	Center	X	O	X	O	X	O

Note: X = Closed/O = Open

* Contact selection is limited to the following options; consult your local Rockwell Automation sales office or Allen-Bradley distributor for other options.

800F **P** - **SJ** **2** **2**
 a **b** **c** **d**

a

Operator Construction	
Code	Description
P	Round plastic operator (IP66, Type 4/4X/13)
M	Round metal operator (IP66, Type 4/13)

b

Operator Type	
Code	Description
SJ	Selector jog

c

Operator Function	
Code	Description
2	2-position
3	3-position

d

Color Cap	
Code	Description
2	Black
3	Green

* Buttons cannot be engraved.

Bulletin 800F
22.5 mm Push Buttons
 Product Selection

Toggle Switch Operators*



Toggle Switch Operator
 Cat. No. 800FM-JM2

Target Table and Operator Position (2-Position)

Contact Type§	Position on Mounting Latch			
		Toggle Left	Center	Toggle Right
N.O.	Left	O	O	X
N.O.	Right	X	O	O
N.O.	Center	X	O	X
N.C.	Left	X	X	O
N.C.	Right	O	X	X
N.C.	Center	O	X	O

Note: X = Closed/O = Open

Target Table and Operator Position (4-Position)‡

Contact Type§	Position on Mounting Latch					
		Toggle Up	Toggle Left	Center	Toggle Right	Toggle Down
N.O.	Left	X	O	O	O	O
N.O.	Right	O	X	O	O	O
N.O.	Center	X	X	O	O	O
N.C.L.B.	Left	O	X	X	X	X
N.C.L.B.	Right	X	O	X	X	X
N.C.L.B.	Center	O	O	X	X	X
N.C.E.B.	Left	O	O	O	O	X
N.C.E.B.	Right	O	O	O	X	O

Note: X = Closed/O = Open

§ Contact selection is limited to the following options, consult your local Rockwell Automation sales office or Allen-Bradley distributor for other options.

800F -
 a b c

a

Operator Construction	
Code	Description
M	Round metal operator (IP66, Type 4/13)

b

Operator Type	
Code	Description
J	Toggle switch

c

Operator Function	
Code	Description
M2	2-position, maintained
R2	2-position, momentary
M4	4-position, maintained
R4	4-position, momentary

10

* Use legend plates 800F-34_ and 800F-35_.

⊛ Silicone boot comes standard with toggle switch, please see page 10-108 for replacement boots.

‡ Must use N.O., N.C.E.B., or N.C.L.B. contact blocks only. Cannot use N.C. or N.O.E.M. contact blocks with 4-position toggle switch.

Back-of-Panel Components

Contact Blocks with Latch — Composite

800F – P X 0 1 E
 a *b* *c* *d* *e*



a

Style	
Code	Description
P	Plastic latch
M	Metal latch

c

N.O. (Normally Open) Circuits	
Code	Description
0	No contact
1	1 N.O.
2	2 N.O.
3	3 N.O.
4	4 N.O.
5	5 N.O.
6	6 N.O.

d

N.C. (Normally Closed) Circuits	
Code	Description
0	No contact
1	1 N.C.
2	2 N.C.
3	3 N.C.
4	4 N.C.
5	5 N.C.
6	6 N.C.

b

Contact Block(s) Termination Style*	
Code	Description
X	Screw termination
Q	Spring-clamp termination

e

Specialty Contact Block(s)	
Code	Description
Blank	Standard blocks
V	Low voltage — QuadCONNECT™
E	N.O. early make
L	N.C. late break
B	N.C. early break
S	N.C. self-monitoring

* Six circuits maximum allowable.

Power Modules with Latch — Composite

800F – M N 3 G
 a *b* *c* *d*



a

Style	
Code	Description
P	Plastic latch
M	Metal latch

c

Voltage	
Code	Description
0	No bulb♣
1	6V AC/DC♣
2	12V AC/DC♣
3	24V AC/DC
4	48V AC/DC♣
5	120V AC
7	240V AC➤

d

Lamp Color⌘	
Code	Description
C	Incandescent
R	Red LED
G	Green LED
Y	Amber LED
W	White LED
B	Blue LED

b

Power Module Type‡§	
Code	Description
D	Incandescent module, screw termination
N	Integrated LED module, screw termination
Q	Integrated LED module, spring-clamp termination

‡ LED modules for use with all illuminated operators. Incandescent module for use with pilot lights, momentary push buttons, and momentary mushroom operators only.

§ Four circuits maximum allowable when power module is used. Contact blocks cannot be stacked on power module.

♣ Only available for incandescent module.

➤ Only available for integrated LED module.

⌘ For best illumination results, LED color should match lens color. For yellow operator, select a white LED.

22.5 mm Push Buttons

Product Selection

Back-of-Panel Components, Continued

Power Modules with Contact Blocks and Latch — Composite

800F – P N 5 R X 1 0 E
a *b* *c* *d* *e* *f* *g* *h*

a

Style	
Code	Description
P	Plastic latch
M	Metal latch

b

Power Module Type*⊛	
Code	Description
D	Incandescent module, screw termination
N	Integrated LED module, screw termination
Q	Integrated LED module, spring-clamp termination

c

Voltage	
Code	Description
0	No bulb‡
1	6V AC/DC‡
2	12V AC/DC‡
3	24V AC/DC
4	48V AC/DC‡
5	120V AC
7	240V AC§

d

Lamp Color*	
Code	Description
C	Incandescent
R	Red LED
G	Green LED
Y	Amber LED
W	White LED
B	Blue LED

e

Contact Block(s) Termination Style	
Code	Description
X	Screw termination
Q	Spring-clamp termination

f

N.O. (Normally Open) Circuits	
Code	Description
0	No contact
1	1 N.O.
2	2 N.O.
3	3 N.O.
4	4 N.O.

g

N.C. (Normally Closed) Circuits	
Code	Description
0	No contact
1	1 N.C.
2	2 N.C.
3	3 N.C.
4	4 N.C.

h

Specialty Contact Block(s)	
Code	Description
Blank	Standard blocks
V	Low voltage — QuadCONNECT™
E	N.O. early make
L	N.C. late break
B	N.C. early break
S	N.C. self-monitoring

* Four circuits maximum allowable when power module is used. Contact blocks cannot be stacked on power module.

⊛ LED modules for use with all illuminated operators. Incandescent module for use with pilot lights, push buttons, and momentary mushroom operators only.



‡ Only available for incandescent module.

§ Only available for integrated LED module.

* For best illuminated results, LED should match lens color. For yellow operator, select a white LED.

Back-of-Panel Components, Continued

Other

	Description	Pkg. Quantity	Cat. No.	
 Cat. No. 800F-ALM	Metal Mounting Latch These are zinc-plated, metal die cast mounting latches. Note: Sold only in multiples of 10. Order (quantity of) 10 to receive one package of 10 pieces.	10	800F-ALM	
	Note: Sold only in multiples of 100. Order (quantity of) 100 to receive one package of 100 pieces.	100	800F-ALM-BP	
 Cat. No. 800F-ALP	Plastic Mounting Latch Note: Sold only in multiples of 10. Order (quantity of) 10 to receive one package of 10 pieces.	10	800F-ALP	
	Note: Sold only in multiples of 100. Order (quantity of) 100 to receive one package of 100 pieces.	100	800F-ALP-BP	
 Cat. No. 800F-X10	Contact Block Note: Sold only in multiples of 10. Order (quantity of) 10 to receive one package of 10 pieces. Latch not included.	10	N.O.	800F-X10
			N.C.	800F-X01
			N.O. low voltage — QuadCONNECT™	800F-X10V
			N.C. low voltage — QuadCONNECT™	800F-X01V
			N.O.L.M.	‡ * 800F-X10N
			N.O.E.M.	800F-X10E
			N.O.E.E.M.	> 800F-X10M
			N.C.L.B.	800F-X01L
			N.C.E.B.	* 800F-X01B
			Self-Monitoring	* 800F-X01S
			Dual circuit of 2 N.O.	* 800F-X02D
			Dual circuit of 2 N.C.	* 800F-X02D
			Dual circuit of 1 N.O.-1 N.C.	* 800F-X11D
			N.O. with stab terminals	800F-X10T
			N.C. with stab terminals	800F-X01T
			N.O. spring-clamp	800F-Q10
			N.C. spring-clamp	800F-Q01
			N.O. spring-clamp low-voltage — QuadConnect™	800F-Q10V
			N.C. spring-clamp low-voltage — QuadConnect™	800F-Q01V
			N.O.E.M. spring-clamp	800F-Q10E
			N.C.L.B. spring clamp	800F-Q01L
			N.C.E.B. spring-clamp	* 800F-Q01B
			Ring lug N.O.	‡§ 800F-R10
Ring lug N.C.	‡§ 800F-R01			
Note: Sold only in multiples of 100. Order (quantity of) 100 to receive one package of 100 pieces. Latch not included.	N.O.	100	800F-X10-BP	
	N.C.	100	800F-X01-BP	

- * For use with Cat. No. 800FP-CB_ and Cat. No. 800FP-CC_ operators.
- > For use with Cat. No. 800FP-CC_ operators.
- * Only for use with 4-position selector switch, 4-position toggle switch, or 3-position push-pull operator.
- * Cannot stack.
- ‡ Cannot be used in a composite catalog number.
- § Replacement screws are available (Cat. No. 800F-ARS1)





10

22.5 mm Push Buttons

Product Selection

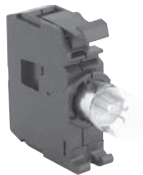
Back of Panel Components, Continued

Other

	Description	Volts	Pkg. Quantity	Cat. No.
 <p>Cat. No. 800F-D3C</p>	<p>Incandescent Module For use with pilot lights, push buttons, and momentary mushroom operators. Note: Sold in multiples of 10. Order (quantity of) 10 to receive one package of 10 pieces. Latch not included.</p>	No bulb	10	800F-D0C
		6V AC/DC		800F-D1C
		12V AC/DC		800F-D2C
		24V AC/DC		800F-D3C
		48V AC/DC		800F-D4C
		120V AC/DC		800F-D5C
 <p>Cat. No. 800F-N3G</p>	<p>Integrated LED Module For use with all illuminated devices. For best results, LED should match lens color. For amber operators, use yellow LED. Note: Sold in multiples of 10. Order (quantity of) 10 to receive one package of 10 pieces. Latch not included.</p>	24...120V AC/DC	10	* 800F-NUx
		24V AC/DC		* 800F-N3x
		120V AC		* 800F-N5x
		240V AC		* 800F-N7x
		24V AC/DC spring-clamp		* 800F-Q3x
		120V AC spring-clamp		* 800F-Q5x
		240V AC spring-clamp		* 800F-Q7x
		24V AC/DC ring lug		*† 800F-R3x
	Description	Contact Material	Pkg. Quantity	Cat. No.
 <p>Cat. No. 800F-BX01</p>	<p>Base Mounted Contact Block Base mounted contact blocks can be used in plastic or metal enclosures. Note: Sold only in multiples of 10. Order (quantity of) 10 to receive one package of 10 pieces. Latch not included.</p>	N.O.	10	800F-BX10
		N.C.		800F-BX01
		N.O. low voltage — QuadConnect™		800F-BX10V
		N.C. low voltage — QuadConnect™		800F-BX01V
		N.O.E.M.		800F-BX10E
		N.C.L.B.		800F-BX01L
		N.O. spring-clamp		800F-BQ10
		N.C. spring-clamp		800F-BQ01
	Description	Volts	Pkg. Quantity	Cat. No.
 <p>Cat. No. 800F-BN3R</p>	<p>Base Mounted Integrated LED Module Base mounted modules can be used in plastic or metal enclosures. For best illumination results, LED should match lens color. Note: Sold in multiples of 10. Order (quantity of) 10 to receive one package of 10 pieces. Latch not included.</p>	24V AC/DC	10	* 800F-BN3x
		120V AC		* 800F-BN5x
		240V AC		* 800F-BN7x

* To complete the cat. no., replace the x with one of the following letters for the desired color: **Y** = Amber, **R** = Red, **G** = Green, **B** = Blue, **W** = White.

*† Cannot be used in a composite catalog number.

† Replacement screws are available (Cat. No. 800F-ARS1)

Plastic and Metal Enclosures



Plastic Enclosure
 Cat. No. 800F-3PM



Metal Enclosure
 Cat. No. 800F-5MM

Plastic Enclosures (Latch or Base Mounting)

- Accepts two-piece snap-in legends
- One-hole enclosure accepts 60 mm emergency stop legends
- UL Listed, CSA Certified

Metal Enclosures (Latch or Base Mounting)

- Feed-through design
- Accepts two-piece snap-in legends
- Includes base mount adapter

Type	Pkg. Quantity	Enclosures							
		Plastic (IP66, 4/4X)				Metal — Die Cast (IP66, 4/13)*			
		PG Conduit Knockouts		Metric Conduit Knockouts		PG Conduit Openings		Metric Conduit Openings	
		Cat. No.		Cat. No.		Cat. No.		Cat. No.	
1-hole	1	*‡	800F-1PP	*‡	800F-1PM	♣	800F-1MP	♣	800F-1MM
2-hole		*‡	800F-2PP	*‡	800F-2PM	♣	800F-2MP	♣	800F-2MM
3-hole		*‡	800F-3PP	*‡	800F-3PM	♣	800F-3MP	♣	800F-3MM
4-hole		*‡	800F-4PP	*‡	800F-4PM				
5-hole		—		—		>	800F-5MP	>	800F-5MM
6-hole		*§	800F-6PP	*§	800F-6PM				
1-hole (yellow)		*	800F-1YP	*	800F-1YM	♣	800F-1MYP	♣	800F-1MYM
1-hole (yellow) latch only			—		—	♣	800F-1LYP	♣	800F-1LYM
1-hole (yellow) dual circuit		⊛	800F-1YPD	⊛	800F-1YMD				

- * Can only use single deep contact block.
- ⊛ Can stack contact blocks two deep or one dual circuit contact block.
- ‡ Knockouts: PG (PG11/16), Metric (M16/20)
- § Knockouts: PG (PG16), Metric (M25)
- ♣ Openings: PG (PG16), Metric (M20)
- > Openings: PG (PG16), Metric (M32)

Assembled Stations

Enclosure Material	Operator Type	Illumination Voltage	Contact Configuration	Cat. No.	
				PG Knockouts	Metric Knockouts
1-Hole, Yellow Plastic	Red 90 mm momentary	Non-illuminated	1 N.C.	800F-1YP1M94	800F-1YM1M94
			1 N.O./1 N.C.	800F-1YP2M94	800F-1YM2M94
			2 N.C.	800F-1YP3M94	800F-1YM3M94
1-Hole, Grey Plastic	Black 90 mm momentary		1 N.O./1 N.C.	800F-1PP2M92	800F-1PM2M92
	Black Push Button		1 N.O.	800F-1PP1	800F-1PM1
	"0-1" 2-Position Selector Switch		1 N.O.	800F-1PP2	800F-1PM2
	"OFF-ON" 2-Position Selector Switch		1 N.O. / 1 N.C.	800F-1PP3	800F-1PM3
	↔ (Flush Black)		1 N.O.	800F-1PP4	—
2-Hole, Grey Plastic	Start and Stop Push Buttons		1 N.O./1 N.C.	800F-2PP1	—
3-Hole, Grey Plastic	↑ (Flush Black) O (Extended Red) ↓ (Flush Black)		4 N.O./1 N.C.	800F-3PP1	—

Bulletin 800F
22.5 mm Push Buttons
 Product Selection

1-Hole Enclosure E-Stop Station



Cat. No. 800F-1YP4

Enclosure Material	Quick Connect	Operator Type	Illumination Voltage	Contact Configuration	Cat. No.	
					PG Knockouts	Metric Knockouts
Yellow Plastic	N/A	Twist-to-Release 40 mm	Non-Illuminated	1 N.C.	800F-1YP1	800F-1YM1
				1 N.O. / 1 N.C.	800F-1YP2	800F-1YM2
		2 N.C.		800F-1YP3	800F-1YM3	
		1 N.C.		800F-1YP4	800F-1YM4	
		1 N.O. / 1 N.C.		800F-1YP5	800F-1YM5	
		2 N.C.		800F-1YP6	800F-1YM6	
		2 N.C.		800F-1YP7	—	
		1 N.O. / 2 N.C.		800F-1YP8	—	
		Twist-to-Release 40 mm	24V AC/DC	1 N.C.	—	800F-1YML1
			120V AC		—	800F-1YML2
		240V AC	—		800F-1YML3	
		Red half dome	Non-illuminated	1 N.C.	800F-1YP1HD	800F-1YM1HD
				1 N.O./1 N.C.	800F-1YP2HD	800F-1YM2HD
				2 N.C.	800F-1YP3HD	800F-1YM3HD
	1 N.C.		24V AC/DC	—	800F-1YML1HD	
			120V AC	—	800F-1YML2HD	
			240V AC	—	800F-1YML3HD	
	AC Micro*	5-pin	Non-Illuminated	2 N.C. — Low voltage	—	800F-1YMQ53V
		6-pin		1 N.O. / 2 N.C.	—	800F-1YMQA
	DC Micro*	4-pin	Non-Illuminated/EMO/Guard	1 N.C.	—	800F-NX1
				1 N.C.	—	800F-1YMQ1
			Non-Illuminated	1 N.O. / 1 N.C.	—	800F-1YMQ2
		2 N.C.		—	800F-1YMQ3	
				—	800F-1YMQ3VEG	
		Mini Receptacle *	4-pin	Non-Illuminated	1 N.C.	—
	24V AC/DC			1 N.O. / 1 N.C.	—	800F-1YMQ44
	6-pin		24V AC/DC	1 N.O./1 N.C.	—	800F-1YMQ4
			120V AC	1 N.O. / 1 N.C.	—	800F-1YMQ5
240V AC	1 N.O. / 1 N.C.	—	800F-1YMQ6			
	N/A	Twist-to-Release 40 mm	Non-Illuminated	1 N.C.	—	800F-1MM1
Twist-to-Release 40 mm		Non-Illuminated	1 N.O. / 1 N.C.	—	800F-1MM2	
Twist-to-Release 40 mm		Non-Illuminated	2 N.C.	—	800F-1MM3	
Key Release 40 mm		Non-Illuminated	1 N.C.	—	800F-1MM4	
Key Release 40 mm		Non-Illuminated	1 N.O. / 1 N.C.	—	800F-1MM5	
Key Release 40 mm		Non-Illuminated	2 N.C.	—	800F-1MM6	
Mini Receptacle *	6-pin	Twist-to-Release 40 mm	24V AC/DC	1 N.O./1 N.C.	—	800F-1MYMQ4
		Twist-to-Release 40 mm	120V AC	1 N.O./1 N.C.	—	800F-1MYMQ5
		Twist-to-Release 40 mm	240V AC	1 N.O./1 N.C.	—	800F-1MYMQ6

* Please reference Assembled Station Pin Out Chart on page 10-126



Assembled Stations with DeviceNet

2-Hole

800F –

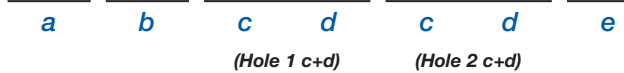

3-Hole

800F –

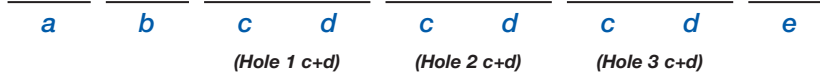

4-Hole

800F –

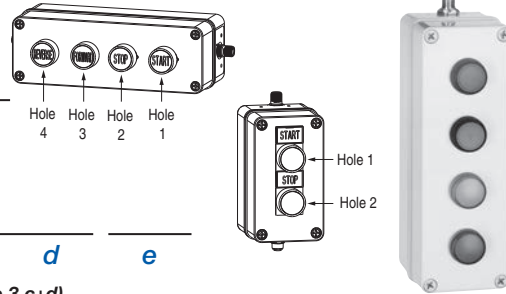
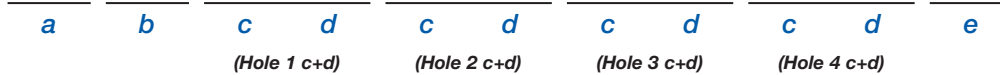

4-Hole Assembled Station
 Cat. No. 800F-VHA3A4J3J4J

a

Mounting Orientation	
Code	Description
V	Vertical*
H	Horizontal

b

Enclosure Style/Legends	
Code	Description
A	2-hole/legend frames
B	3-hole/legend frames
C	4-hole/legend frames
D	2-hole/no legend frames
E	3-hole/no legend frames
F	4-hole/no legend frames
H	2-hole/E-stop only no legend frames*

c

Operator Types	
Code	Description
A	Non-illuminated flush button
B	Non-illuminated extended button
C	Non-illuminated guarded button
D	Illuminated flush button+
E	Illuminated extended button+
F	Illuminated guarded button+
G	Non-illuminated 2-pos. selector switch
H	Non-illuminated 3-pos. selector switch
J	Pilot light (diffused)
K	Hole plug*
L	Non-illuminated TTR E-stop†‡
M	Non-illuminated push pull†‡
N	2-pos. key selector switch
P	3-pos. key selector switch
R	Non-illuminated 40 mm mushroom
T	E-stop key release†‡
U	Potentiometer§
W	Illuminated push pull
X	Illuminated 2-pos. maintained selector switch
Y	Illuminated 3-pos. maintained selector switch
Z	Illuminated 40 mm mushroom

d

Color/Text	
Code	Description
1	White
2	Black
3	Green
4	Red
5	Yellow
6	Blue
7	Clear
8	Grey*
9	No cap
0	Amber
A	Green with "Start" text
B	Red with "Stop" text
C	Black with "→" symbol
D	Black with "←" symbol
E	Black with "↑" symbol
F	Black with "↓" symbol
G	Green with "I" symbol
H	Red with "O" symbol
L	Blue with "R" text
M	Red with yellow metal guard*
N	Yellow with yellow metal guard*

e

I/O Version➤	
Code	Description
Blank	No external I/O
A	1 input/1 output (sinking)
B	1 input/1 output (sourcing)
C	2 input
D	2 output (sinking)
E	2 output (sourcing)
F	1 E-stop block‡
G	2 E-stop block‡
H	2 input/2 output
J	2 input/2 output (sinking)
K	2 input/2 output (sourcing)
L	1 input/1 output (sinking) + 1 E-stop block‡
M	1 input/1 output (sourcing) + 1 E-stop block‡
N	1 input/1 output (sinking) + 2 E-stop block‡
P	1 input/1 output (sourcing) + 2 E-stop block‡
Q	2 input + 1 E-stop block‡
R	2 input + 2 E-stop block‡
T	2 output (sinking) + 1 E-stop block‡
U	2 output (sourcing) + 1 E-stop block‡
V	2 output (sinking) + 2 E-stop block‡
W	2 output (sourcing) + 2 E-stop block‡
X	2 input + 1 input/1 output (sinking)
Y	2 input + 1 input/1 output (sourcing)

- * Selector Switches in a vertical mount enclosure are mounted with a horizontal orientation.
- * Enclosure Style/Legend option H from Table b can only select one operator from Table c. Valid options are L, M and T. Also see footnote †
- † Operator Types L, M, and T from Table c may be used as emergency stops. To be valid as an E-Stop, operators must use color/text option 4 from Table d and it must be placed in the last hole position in the enclosure, where a yellow round E-stop legend plate is provided. An E-Stop connector also must be chosen from Table e. Also see footnote ‡
- ‡ Potentiometer allowed in first hole position only.
- ‡ Available in flush only.
- This is an 8-in/4-out device. 2-in and 1-out are assigned to each hole position in the enclosure. If a 2-hole enclosure is selected, 4-in and 2-out are assigned internally and up to 4 unassigned I/O points can be assigned to external connectors. This device contains up to two physical external I/O connectors. The "+" symbol in the Description field of table e indicates that two external connectors exist. If an E-Stop connector is used, 2 unassigned I/O points can be assigned to the other connector.
- ‡ External I/O Versions F, L, M, Q, T, and U receive only one contact block for the external E-Stop string. These connectors are rated 3 A. If more than 3 A of current is needed or if there are two E-Stop strings, use External I/O Versions G, N, P, R, V and W. These versions receive two contact blocks. This allows for 6 A of switching or for two E-Stop strings.
- † Cannot be ordered with "No Cap" (9 from Table d - Color/Text).
- ‡ Operator Types K, L, M, T, and U from Table c are not available with legend frames.
- * Only available with non-illuminated push-pull operator (M from Table c).

22.5 mm Push Buttons

Product Selection

Pendant Stations (Latch Mounting)*

- Blank legend cap marking
- Connector not included. See Accessories, page 10-107, for ordering information.



Pendant Station
Cat. No. 800F-P25

Type	Pkg. Quantity	Pendants	
		Yellow Plastic (IP66, 4/4X/13)	
		Cat. No.	
1 hole in face	1	800F-P15	
2 holes in face		800F-P25	
1 hole in bottom		800F-P35	
1 hole in face / 1 hole in bottom		800F-P45	

Assembled Two-Hole Pendant Stations*











Pendant Station
Cat. No. 800F-PN2

Pre-Wired Pendant Station with Mini Quick Disconnect Connector	
Push Button and Contact Selection	Cat. No.
Green flush (no text) in face with 1 N.O. contact; Red pilot light in bottom with 1 N.O. contact; 24V AC/DC	800F-PN2
White flush (with up arrow — ↑) with 1 N.O./1 N.C. contact; Black flush (with down arrow — ↓) with 1 N.O./1 N.C. contact	800F-P251
Black flush (with "Forward" text) with 1 N.O./1 N.C. contact; Black flush (with "Reverse" text) with 1 N.O./1 N.C. contact	800F-P252
Black flush (with "On" text) with 1 N.O. contact; Black flush (with "Off" text) with 1 N.C. contact	800F-P253
Green flush (with "Start" text) with 1 N.O. contact; Red flush (with "Stop" text) with 1 N.C. contact	800F-P254
2 flush black push buttons (no text), each with 1 N.O. contact	800F-P255
DeviceNet Pendant Station with Mini Quick Disconnect Connector	
Options	Cat. No.
Green flush push button in face, red pilot light in bottom; 24V DC	800F-PND2

* Can only use single deep contact block.







Miscellaneous

	Description	Type	Pkg. Quantity	Cat. No.
 Cat. No. 800F-AHA1	30.5 mm to 22.5 mm Hole Size Adapter This adapter allows a 22.5 mm push button operator to be installed in a panel with existing 30.5 mm mounting holes. Note: Comes with anti-rotation washer (800F-ALC1).	Metal	1	800F-AHA1
 Cat. No. 888N-M4AF1-1F	Quick Disconnect Male receptacle for pendant stations.	4-pin		888N-M4AF1-1F
		5-pin		888N-M5AF1-1F
	Description	Material	Pkg. Quantity	Cat. No.
 Cat. No. 800F-ARP	Replacement Mounting Rings	Plastic	10*	800F-ARP
		Metal		800F-ARM
	Description		Pkg. Quantity	Cat. No.
 Cat. No. 800F-AW2	Mounting Ring Wrench This mounting ring wrench is used to tighten plastic or metal mounting rings quickly and securely.		1	800F-AW2
 Cat. No. 800F-ALR1	Bulb Removal Tool For quick and easy removal of lamps from incandescent modules.			800F-ALR1
 Cat. No. 1492-MS5X9	Snap-In Marker This item can be used for circuit identification on all back-of-panel components.		—	*
 Cat. No. 800F-ATK2	Stab Terminals Can be used with all single circuit contact blocks. Minimum spacing requirements apply. See instruction sheet for details. Note: Sold only in multiples of 100. Order (quantity of) 100 to receive one package of 100 pieces.		100	800F-ATK2
 Cat. No. 800F-AGS1	Ground Screws These are self-tapping #6-32 (M3.5) ground screws for metal latches.		10*	800F-AGS1
 Cat. No. 800F-AGS2	Ground Screws This accessory is used for grounding on Bulletin 800F plastic enclosures only.			800F-AGS2

* See Terminal Block section for ordering information.





* Sold only in multiples of 10. Order (quantity of) 10 to receive one package of 10 pieces.

Miscellaneous, Continued

	Description	Panel Thickness with Legend Plates	Pkg. Quantity	Cat. No.
 <p>Cat. No. 800F-ALC1</p>	<p>Locking Washer (Anti-Rotation Washer) This item provides an extra anti-rotation feature for rotary operators such as selector switches.</p>	1...4 mm	10‡	800F-ALC1
		1...5 mm		800F-ALC2
	Description		Pkg. Quantity	Cat. No.
 <p>Cat. No. 800F-ATW1</p>	<p>Replacement Trim Washer This accessory comes standard with all enclosures. It must be used if using base-mounted contact blocks/power modules without legend plates.</p>		10‡	800F-ATW1
 <p>Cat. No. 800F-A3BA</p>	<p>Replacement Base Mount Adapter This accessory comes standard with all metal enclosures. It is required when using metal enclosures with base-mounted contact blocks or base-mounted power modules.</p>			800F-A3BA
 <p>Cat. No. 800F-ABZ1</p>	<p>Square Bezel Gives round operator a square appearance. This item is made of plastic. Not for use with toggle switch operators.</p>			800F-ABZ1
	Description	Material	Pkg. Quantity	Cat. No.
 <p>Cat. No. 800F-ABJS</p>	<p>Replacement Boot for Toggle Switch</p>	Silicone	1	800F-ABJS
		Nitrile		800F-ABJN
 <p>Cat. No. 800F-N2</p>	<p>Hole Plug used to plug 22.5 mm holes.</p>	Black plastic		800F-N2
		Grey plastic		800F-N8
 <p>Cat. No. 800F-ACP</p>	<p>Selector Switch Tabs Changes functionality of selector switch from normal to CenterLeft or CenterRight.</p>		10‡	800F-ACP







‡ Sold only in multiples of 10. Order (quantity of) 10 to receive one package of 10 pieces.

Guards





	Description	Type	Pkg. Quantity	Cat. No.
 Cat. No. 800F-AMRG	Protective Ring for use with non-illuminated 2-position maintained and illuminated/non-illuminated 3-position mushroom operators (40 mm only)	Shiny metal	1	800F-AMRG
		Black		800F-AMRGB
		Yellow Metal		800F-AMRGY
 Cat. No. 800F-A6PR5	Plastic Guard for use with the following operators: <ul style="list-style-type: none"> • 40 mm E-stop (SEMI Standards Compliant) • 40 mm illuminated/non-illuminated alternate action and momentary operators • 60 mm illuminated/non-illuminated momentary operators • Selector switches (standard knob and key operated) • Potentiometers 	Yellow, round	1	800F-A6PR5
 Cat. No. 800F-AMEGY	Narrow Plastic Guard for use with the following operators: <ul style="list-style-type: none"> • Illuminated and non-illuminated momentary mushroom operators (40 mm) only • Bul. 800FD monolithic E-stops (SEMI standards compliant) • Flush/extended/guarded push buttons • Alternate action operators • Selector switches (standard knob and key operated) • Potentiometers 	Yellow		800F-AMEGY
 Cat. No. 800F-AMMG	40 mm Protective Guard used with illuminated and non-illuminated momentary mushroom operators (40 mm) only.	Shiny Metal		800F-AMMG
 Protective Boots	Clear silicone Protective Boot used on illuminated and non-illuminated, flush and extended operators.	Flush push button	10*	800F-AB7
		Extended push button		800F-ABE7
		3-position multi-function		800F-AUB1
		2-position multi-function		800F-AUB2

* Sold in multiples of 10. Order (quantity of) 10 to receive one package of 10 pieces.

Locking Attachments



	Description	Type	Pkg. Quantity	Cat. No.
 <i>Cat. No. 800F-AFL1</i>	Locking Attachments are used to lock push button in the depressed position. -N.C. contacts are open -N.O. contacts may or may not be open -N.C.L.B. contacts may or may not be closed -N.O.E.M contacts are closed	Flush momentary, non-illuminated	1	800F-AFL1
 <i>Cat. No. 800F-AEL1</i>		Extended momentary, non-illuminated		800F-AEL1
 <i>Cat. No. 800F-AML1</i>		Momentary mushroom		800F-AML1
 <i>Cat. No. 800F-AML2</i>		Maintained mushroom		800F-AML2
	Description	Lock Position	Pkg. Quantity	Cat. No.
 <i>Cat. No. 800F-ASL2L</i>	Selector Switch Locking Attachment Locks standard knob selector switch in specified position	2-position selector switches, left lock	1	800F-ASL2L
		3-position selector switches, center lock		800F-ASL3C
 <i>Cat. No. 800F-ASL23A</i>	Selector Switch Locking Attachment Ability to put two locks on standard knob selector switch.	2- or 3-position selector switches, all positions		800F-ASL23A
	Description	Type	Pkg. Quantity	Cat. No.
 <i>Cat. No. 800F-AL01</i>	Locking Cover Used on flush, extended and guarded momentary and alternate action operators, and standard knob selector switch operators.	—	1	800F-AL01

Other Accessories

	Description	PQ	Key No. (Std)	Cat. No.	Key No. (Std)	Cat. No.
 Cat. No. 800F-AKR3825	Replacement Ronis Key Standard replacement key is Cat. No. 800F-AKR3825.	1*	3825	800F-AKR3825	3910*	800F-AKR3910
			455	800F-AKR455	3920*	800F-AKR3920
			3801	800F-AKR3801	4001	800F-AKR4001
			3802	800F-AKR3802	4002	800F-AKR4002
			3803	800F-AKR3803	4003	800F-AKR4003
			3804	800F-AKR3804	4004	800F-AKR4004
			3805	800F-AKR3805	4005	800F-AKR4005
			3806	800F-AKR3806	4006	800F-AKR4006
			3901*	800F-AKR3901	4007	800F-AKR4007
Description				Volts	PQ	Cat. No.
 Cat. No. 800F-XD7	Diode Module For lamp checking circuits. Latch not included.	up to 600V AC	10‡		800F-XD7	
	Null Block For wire terminations only.				800F-NX70	
Description				PQ	Cat. No.	
 Cat. No. 800F-30WN	Potentiometer Legend Plate Scale 1...10	10‡			800F-30WN	
 Cat. No. 800F-30WG	Potentiometer Legend Plate Graphical scale				800F-30WG	
Description				Resistance	PQ	Cat. No.
 Cat. No. 800F-AC1	Replacement Resistive Elements for the 800FP Potentiometer operator.	1	150 Ω		800F-AC1	
			500 Ω		800F-AC2	
			1000 Ω		800F-AC3	
			2500 Ω		800F-AC4	
			5000 Ω		800F-AC5	
			10000 Ω		800F-AC6	

PQ = Pkg. Quantity
 * Master key. See page 10-83 for details.
 † Standard package quantity is one set with two keys.
 ‡ Sold only in multiples of 10. Order (quantity of) 10 to receive one package of 10 pieces.

Replacement Lamps for Incandescent Module

Lamp	Type	Typical Current	Voltage	ANSI No.	Pkg. Quantity	Cat. No.
 Cat. No. 800F-N130	Full Voltage Incandescent	150 mA	6V AC/DC	755	10§	800F-N65
		80 mA	12V AC/DC	756		800F-N141
		70 mA	24V AC/DC	757		800F-N157
		50 mA	48V AC/DC	1835		800F-N48
		22 mA	130V AC/DC	949		800F-N130
 Cat. No. 800F-N240	Neon	2 mA	240V AC	—		800F-N240
	LED	50 mA	6V AC/DC	—		♣ 800T-N318x
		12 mA/17 mA	32V AC/DC	—		♣ 800T-N363x
		9 mA/14 mA	48V AC/DC	—		♣ 800T-N364x
		4.5 mA/6.2 mA	130V AC/DC	—		♣ 800T-N321x

§ Sold in multiples of 10. Order (quantity of) 10 to receive one package of 10 pieces.
 ♣ To complete the cat. no., replace the x with one of the following letters for the desired color: **A** = Amber; **B** = Blue; **G** = Green; **R** = Red; **W** = White. White LEDs only available in 6V and 130V.

22.5 mm Push Buttons

Accessories

Caps, Diffusers, Lenses

Color caps listed below are for completion of devices ordered with color caps omitted.

Accessory Color Caps (without Text)

	Color Caps, Non-Illuminated*				
	Color	Pkg. Quantity	Momentary Extended	Momentary Flush/Guarded	Alternate Action Flush
			Cat. No.	Cat. No.	Cat. No.
	Orange	10	800F-AE0	800F-AF0	800F-AFA0
	White		800F-AE1	800F-AF1	800F-AFA1
	Black		800F-AE2	800F-AF2	800F-AFA2
	Green		800F-AE3	800F-AF3	800F-AFA3
	Red		800F-AE4	800F-AF4	800F-AFA4
	Yellow		800F-AE5	800F-AF5	800F-AFA5
	Blue		800F-AE6	800F-AF6	800F-AFA6
	Grey		—	800F-AF8	—

Accessory Color Caps — Multi-Function Operators (without Text)

	Color Caps, Non-Illuminated*			
	Color	Pkg. Quantity	Flush	Extended
			Cat. No.	Cat. No.
	White	10	800F-AFU1	800F-AEU1
	Black		800F-AFU2	800F-AEU2
	Green		800F-AFU3	800F-AEU3
	Red		800F-AFU4	800F-AEU4
	Yellow		800F-AFU5	800F-AEU5
	Blue		800F-AFU6	800F-AEU6

Accessory Color Lens Caps and Pilot Light Lenses (without Text)

	Color	Pkg. Quantity	Illuminated Color Lens Caps* — Flush, Alternate Action	Illuminated Color Lens Caps* — Extended, Guarded	Pilot Light Lenses** — Standard Lens
			Cat. No.	Cat. No.	Cat. No.
	Amber	10	800F-ALF0	800F-ALE0	800F-AP0
	Green		800F-ALF3	800F-ALE3	800F-AP3
	Red		800F-ALF4	800F-ALE4	800F-AP4
	Yellow		800F-ALF5	800F-ALE5	800F-AP5
	Blue		800F-ALF6	800F-ALE6	800F-AP6
	Clear		800F-ALF7	800F-ALE7	800F-AP7

* Sold only in multiples of 10. Order (quantity of) 10 to receive one package of 10 pieces.

** Includes diffuser.

Operator Diffusers (without Text)

	Diffusers		
	Description	Pkg. Quantity	Cat. No.
 <p>Cat. No. 800F-AD3</p>	Illuminated Push Buttons — Flush	10	800F-AD2
	Pilot Lights		800F-AD3
	Illuminated Push Buttons — Extended, Guarded		800F-AD4

10

Two-Color Molded Legend Caps — Non-Illuminated Push Buttons

800F – AF 3 01
 a b c



Cat. No. 800F-15YSE112

a

Button Cap Type	
Code	Description
AF	Flush
AE	Extended

b

Color Cap	
Code	Description
1	White
2	Black
3	Green
4	Red
5	Yellow
6	Blue

c

Legend Text*†	
English	
Code	Description
01	START
02	STOP
05	O
06	I
08	→
09	FORWARD*
10	REVERSE*
11	R

* Available in flush only.
 * White and yellow caps have black text. All other color caps have white text.
 † Valid color cap text codes include:

Color	Text	
	Flush Caps	Extended Caps
White	FORWARD, REVERSE, START, I, →, R	→, R
Black	FORWARD, REVERSE, →, R	STOP, O, →, R
Green	FORWARD, REVERSE, START, I, →	→
Red	FORWARD, REVERSE, STOP, O, →	STOP, O, →
Yellow	FORWARD, REVERSE, →	→
Blue	FORWARD, REVERSE, →, R	→, R

Emergency Stop Legend Plates§

800F – 15YS
 a b

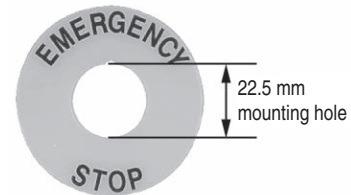

a

Size/Color (Yellow)	
Code	Description
15Y	60 mm round (30.5 mm mounting hole)
15YS	60 mm round (22.5 mm mounting hole)➤
16Y	90 mm round (22.5 mm mounting hole)➤

b

Text	
Code	Description
Blank	No text
E112	EMERGENCY STOP
F112	ARRÊT D'URGENCE‡
S112	PARADA DE EMERGENCIA
G112	NOT HALT
T112	ARRESTO EMERGENZA
N112	NÖDSTOPP, EMERGENCY STOP‡

b (cont'd)

Text	
Code	Description
W112	NÖDSTOPP, EMERGENCY STOP‡
A112	NÖDSTOP
B112	EMERGENCY STOP, ARRÊT D'URGENCE, PARADA DE EMERGENCIA‡
D112	NOODSTOP‡
M112	NOT HALT, ARRESTO EMERGENZA, ARRÊT D'URGENCE➤
	EMERGENCY STOP, ARRÊT D'URGENCE, NOT HALT❖
L112	NEYDARSTOPP, NEYDARSTOPP‡
H112	NÖD-STOP, HÄTÄ-SEIS, NÖD-STOP‡

§ Sold only multiples of 10. Order (quantity of) 10 to receive one package of 10 pieces.
 ➤ Not for use with base mounted contact blocks.
 ‡ Not available on 15YS version.
 ➤ Text printed on the 15Y version only.
 ❖ Text printed on the 15YS & 16Y versions only.



22.5 mm Push Buttons

Accessories

Legend Plates

Ordering Information*§

Standard Text/Symbols

1. Select the cat. no. for the appropriate legend size and color from the Selection Tables on this page.
2. Complete the cat. no. by adding the appropriate suffix no. selected from pages 10-116...10-119. Font size is automatically determined by the number of characters, as shown in the following table. Do not add the font code to the cat. no.

Font Size	No. of Characters		
	One-Piece Legend Plate	Two-Piece Legend Plate	Special Multi-Function Legend Plate
K (small)	>14	>13	>6
S (standard)	≤14	≤13	≤6

Example: **Cat. No. 800F-11WE101** identifies a white, 30 x 40 mm snap-in legend plate and frame with AUTO engraved on it.



Custom Text (text found on pages 10-116...10-119)

1. Select the cat. no. for the appropriate legend size and color from the Selection Tables on this page.
2. Add **E100** followed by the font code (K, S, L) from the following table.

Font Size	Type of Legend Plate							
	One-Piece				Two-Piece			Special Multi-Function
	Max. Char. per Line	Max. No. of Lines		Max. Char. per Line	Max. No. of Lines		Max. Char. per Line	Max. No. of Lines
		30 x 40 mm	30 x 50 mm		30 x 40 mm	30 x 50 mm or 30 x 60 mm		
K (small)	16	2	5	15	2	5	7	3
S (standard)	14	2	3	13	1	3	6	3
L (large)	10	1	3	9	1	3	4	2

3. Complete the cat. no. by adding custom text to the order item's memo text or notes field.

Example: **Cat. No. 800F-12WE100K**, with **STARTER** text entered into memo text on order, identifies a white, 30 x 50 mm snap-in legend plate and frame with custom text STARTER engraved in small font.



Selection Tables*

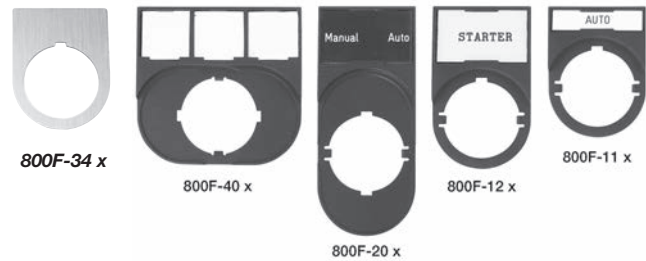

Type	Description	Cat. No. (Blank)	Cat. No. (with Text Symbols)
30 x 40 mm 2-piece snap-in plate and frame	Red with white text	800F-11RE100	800F-11R□□□□
	White with black text	800F-11WE100	800F-11W□□□□
	Black with white text	800F-11BE100	800F-11B□□□□
30 x 50 mm 2-piece snap-in plate and frame	Aluminum with black text	800F-11AE100	800F-11A□□□□
	White with black text	800F-12WE100	800F-12W□□□□
	Black with white text	800F-12BE100	800F-12B□□□□
30 x 60 mm 2-piece snap-in plate and frame	Aluminum with black text	800F-12AE100	800F-12A□□□□
	White with black text	800F-20WE100	800F-20W□□□□
	Black with white text	800F-20BE100	800F-20B□□□□
Special multi-function 4-piece snap-in plates and frame	Aluminum with black text	800F-20AE100	800F-20A□□□□
	White with black text	800F-40WE100	—
	Black with white text	800F-40BE100	—
30 x 40 mm 1-piece	Aluminum with black text	800F-40AE100	—
	Red with white text	800F-34RE100	800F-34R□□□□
	White with black text	800F-34WE100	800F-34W□□□□
30 x 50 mm 1-piece	Black with white text	800F-34BE100	800F-34B□□□□
	Aluminum with black text	800F-34AE100	800F-34A□□□□
	Red with white text	800F-35RE100	800F-35R□□□□
30 x 40 mm snap-in plate only	White with black text	800F-35WE100	800F-35W□□□□
	Black with white text	800F-35BE100	800F-35B□□□□
	Aluminum with black text	800F-35AE100	800F-35A□□□□
30 x 50 mm snap-in plate only	Red with white text	800F-17RE100	800F-17R□□□□
	White with black text	800F-17WE100	800F-17W□□□□
	Black with white text	800F-17BE100	800F-17B□□□□
30 x 60 mm 1-piece	Aluminum with black text	800F-17AE100	800F-17A□□□□
	White with black text	800F-18WE100	800F-18W□□□□
	Black with white text	800F-18BE100	800F-18B□□□□
Special multi-function snap-in plate only‡	Aluminum with black text	800F-18AE100	800F-18A□□□□
	White with black text	800F-42WE100	800F-42W□□□□
	Black with white text	800F-42BE100	800F-42B□□□□
30 x 66 mm 1-piece	Aluminum with black text	800F-42AE100	800F-42A□□□□
	Yellow with black text	800F-37YE100	800F-37Y□□□□

Legend Plate Frame — 2-Piece Snap-In*

Type	Cat. No.	Type	Cat. No.
30 x 40 mm	800F-110	30 x 60 mm	800F-200
30 x 50 mm	800F-120	Special multi-function‡	800F-400

* Blank legend frames sold only in multiples of 10. Order (quantity of) 10 to receive one package of 10 pieces. Legends with standard text/symbols or custom text are packaged in quantities of 1.

§ Font code **K** = 0.08 in; font code **S** = 0.10 in; font code **L** = 0.14 in.

‡ Three snap-in plates are required for each legend frame.

§ For configuration assistance, see RAISE product selection software.

* Plate dimensions found on pages 10-122...10-123.



Custom Laser-Engraved Caps and Diffusers

Ordering Information§**

Standard Text/Symbols

1. Select the cat. no. for the appropriate product and color from the Configurator Tables on this page.
2. Complete the cat. no. by adding the appropriate suffix no. selected from pages 10-116...10-119.

Example: **Cat. No. 800F-AF3CE166** identifies a flush, green cap with custom-engraved text ON.

3. Font size is automatically determined by the number of characters. ‡ Do not add a font code to the cat. no.

Font Size	No. of Characters
12 pt.	7
16 pt.	5...6
20 pt.	1...4

Custom Text (text found on pages 10-116...10-119)

1. Select the cat. no. for the appropriate product and color from the Configurator Tables on this page.
2. Add **E100** followed by the font code (G, H, J), based on the number of custom characters.
3. Complete the cat. no. by adding custom text to the order item's memo text or notes field.

Example: **Cat. No. 800F-AF3CE100J**, with **FILL** text entered into memo text on order, identifies a flush, green push button cap with custom laser-engraved text FILL in large font.

Font Size	No. of Characters	Max. No. of Lines
G (small) (12 pt.)	7	1
H (standard) (16 pt.)	5...6	1
J (large) (20 pt.)	1...4	1

Custom Symbols/Graphics (symbols found on page 10-116)

1. Select the cat. no. for the appropriate product and color from the Configurator Tables on this page.
2. Add U100 to identify the custom symbol or graphic.
3. Please contact your local Allen-Bradley sales office to submit the graphic.

Example: **Cat. No. 800F-AD3CU100**

- * Package quantity of one for all laser-engraved caps and diffusers.
- ‡ Standard font is Arial Narrow.
- ‡ Seven characters maximum allowable.
- § For configuration assistance, see RAISE product selection software.

Configurator Tables

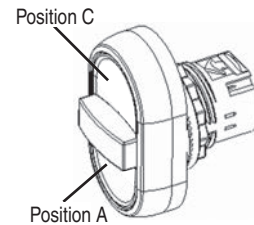

Multi-Function Cap Positions

Push Button, Multi-Function Caps

800F - A $\frac{F}{a}$ $\frac{1}{b}$ C

Type	
Code	Description
E	Push button extended cap
F	Push button flush cap
FA	Alternate action cap
FAU	Multi-function flush cap (for position A)
EAU	Multi-function extended cap (for position A)
FCU	Multi-function flush cap (for position C)
ECU	Multi-function extended cap (for position C)

Color	
Code	Description
0	Amber
1	White
2	Black
3	Green
4	Red
5	Yellow
6	Blue

Pilot Light Diffuser

800F - AD3C

Illuminated Push Button Diffusers

800F - AD2C (Flush or Alternate Action)

800F - AD4C (Extended and Guarded)

Legend Texts

Standard Symbols*

Marking	Description	Std.	Suffix No.
(Blank)	Blank	—	U100
	—	—	U112
	START*†§♣	ISO 71	U219
	—*†§♣	ISO 72	U220
	START*†§♣	ISO 5232	U221
	CONTINUOUS MOTION LEFT, RIGHT ➤	—	U226
	CONTINUOUS MOTION UP, DOWN ➤	—	U227
O	STOP	—	U228
I	STEP 1	—	U229
II	STEP 2	—	U230
O-I	STOP-START ➤	—	U231
I-O	START-STOP ➤	—	U232
I-II	— ➤	—	U233
I-O-II	— ➤	—	U234
	— ➤	—	U236
	— ➤	—	U237
I-II-III	— ➤	—	U240
	CONTINUOUS MOTION	—	U241
	CONTINUOUS MOTION	—	U242
	CONTINUOUS MOTION	—	U243
III	STEP 3	—	U249
O- ➤	— ➤	—	U256
I-O-I	START-STOP-START ➤	—	U282
O-1-2	— ➤	—	U285
IV	STEP 4	—	U604
V	STEP 5	—	U605
	CONTINUOUS MOTION	ISO 1	U700
	LINEAR MOTION TWO DIRECTIONS	ISO 2	U701
	VERTICAL MOTION	—	U702
	INTERRUPTED MOTION*§	—	U703
	LIMITED MOTION*§	ISO 4	U704
	LIMITED MOTION AND RETURN*§	ISO 5	U705
	OSCILLATING MOTION, CONTINUOUS CYCLE*§	—	U706
	CONTINUOUS ROTATION TO RIGHT*§	DIN 100, ISO 7A	U707

Marking	Description	Std.	Suffix No.*§
	CONTINUOUS ROTATION TO LEFT	ISO 7B	U708
	INTERRUPTED ROTATION TO LEFT	—	U710
	INTERRUPTED ROTATION TO RIGHT	—	U711
	DIRECTION OF SPINDLE SPEED	—	U717
	FEED	ISO 16	U720
	REDUCED SPEED	—	U723
	RAPID FEED	—	U724
	NORMAL FEED	—	U725
	LONGITUDINAL FEED	—	U726
	TRANSVERSE FEED	—	U727
	RAPID TRANSVERSE	ISO 26	U728
	THREADING	—	U729
	INCREASE	ISO 28	U730
	DECREASE	ISO 29	U731
	CONVENTIONAL MILLING	—	U736
	CLIMB MILLING	—	U737
	ELECTRIC MOTOR	ISO 41	U800
	TURNING SPINDLE	—	U803
	DRILLING SPINDLE	—	U804
	MILLING SPINDLE	—	U805
	GRINDING SPINDLE	—	U806
	PUMP	ISO 48	U807
	COOLANT PUMP	—	U808
	LUBRICATION PUMP	—	U809
	HYDRAULIC SYSTEMS PUMP	—	U810
	HYDRAULIC MOTOR	—	U811
	TRACER	—	U812
	SHEAR PIN CONSTRUCTION	ISO 91	U850
	ATTENTION/DANGER	DIN 131, ISO 92	U851
	CAUTION	ISO 93	U852
	MAIN SWITCH	ISO 94	U853
	ACOUSTIC WARNING EQUIPMENT	DIN 155	U854
—	—	—	—

* Items in grey shaded table cells only available on legend plates. Not available as laser-engraved text on button caps, illuminated push button diffusers, or pilot light diffusers.

* Not available on -11 or -17 legend plates.

† Not available on -12, -18, or -20 legend plates.

§ Not available on -34 legend plates.

♣ Not available on -35 legend plates.

➤ Not available on -42 legend plates.

Standard Symbols, Continued

Marking	Description	Std.	Suffix No. *§
	SETUP	DIN 986	U855
	COOLANT FLUID	ISO 101	U875
	LIGHT	ISO 139, 102	U876
	WEIGHT	—	U877
	REFILLING	DIN 256, ISO 104	U878
	FULL LEVEL	—	U879
	DRAIN	DIN 257, ISO 106	U880
	OVERFLOW	DIN 258, ISO 105	U881
	OIL LUBRICATION	DIN 175, ISO 107	U882
	BLOWING UNIT	DIN 263, ISO 108	U883
	SUCTION UNIT	DIN 264, ISO 109	U884
	STEPLESS OPERATION	ISO 61	U900
	CLAMP OR TIGHTEN	ISO 63A	U901
	CLAMP OR TIGHTEN	—	U902
	LOOSEN	ISO 64A	U903
	LOOSEN	—	U904
	BRAKE ON	ISO 65	U905
	BRAKE RELEASE	ISO 66	U906
	AUTO CYCLE	—	U907
	MANUAL	DIN 35	U908
	START	ISO 69	U909
	STOP	ISO 70	U910
	TAKE ACTION WHEN CONTROL IS OPERATING	—	U912
	ENGAGE	DIN 46, ISO 74	U913
	DISENGAGE	DIN 45, ISO 75	U914
	ENGAGE TRACE	—	U917
	DISENGAGE TRACE	—	U918
	CHANGE SPEED ONLY IN STOPPED POSITION	—	U919
	CHANGE SPEED ONLY WHEN IN MOTION	—	U920
	CONTINUOUS ADJUSTMENT	ISO 62	U921
	AUTOMATIC OR SEMIAUTOMATIC CYCLE	DIN 267	U922
R	RESET	—	U924

* Not available on -11 or -17 legend plates.

§ Not available on -34 legend plates.

Legend Texts, Continued

Standard Text*

English

Marking	Suffix No.	Marking	Suffix No.	Marking	Suffix No.	Marking	Suffix No.	Marking	Suffix No.
(Blank)	E100	FOR-OFF-REV ▶	E261	LAST STOP	E278	PULL TO RESET	E176	START	E208
I-O-AUTO§♣▶	E235	FOR-REV ▶	E253	LEFT	E145	PUMP STOP	E290	START CYCLE	E209
ACCU-STOP ▶	E284	FOR-STOP-REV ▶	E254	LEFT-RIGHT ▶	E146	PURGE	E271	START-JOG ▶	E210
AT SPEED	E285	FORWARD	E120	LOCAL-REMOTE ▶	E147	PUSH TO STOP	E179	START-STOP ▶	E211
AUTO	E101	FORWARD-AUTO-REVERSE ▶	E121	LOW	E148	PUSH TO STOP-TWIST OR PULL, RELEASE※§▶	E262	STOP	E212
AUTO-O-HAND§♣▶	E250			LOW-HIGH ▶	E149			STOP-CYCLE ▶	E213
AUTO-HAND ▶	E102	FORWARD-OFF-REVERSE ▶	E122	LOW-OFF-HIGH ▶	E150	PUSH-TO-TEST	E181	STOP-RESET ▶	E214
AUTO-MAN-OFF ▶	E103			LOW SPEED	E151	RAISE	E182	STOP-START ▶	E215
AUTO-MANUAL ▶	E286	FORWARD-STOP-REVERSE ▶	E123	LOWER	E152	RAISE-LOWER ▶	E183	SUMMER-OFF-WINTER ▶	E216
AUTO-OFF-HAND ▶	E104			LOW-OFF-RAISE ▶	E153	RAISE-OFF-LOWER ▶	E184		
BLOWER	E268	FORWARD-REVERSE ▶	E124	LOWER-RAISE ▶	E154	READY	E185	SUMMER-WINTER ▶	E217
BRAKE	E105			MANUAL	E155	RESET	E186	SUPPLY ON	E218
BYPASS-OFF-DRIVE§♣▶	E297	FULL SPEED	E125	MAN-O-AUTO§♣▶	E238	RETURN	E187	TEST	E219
BYPASS ON§♣▶	E295	HAND	E126	MAN-AUTO ▶	E258	REV-FOR ▶	E260	TRANSFER ▶	E220
BYPASS START§♣▶	E299	HAND-I-AUTO§♣▶	E239	MANUAL-AUTO ▶	E156	REVERSE	E188	TRIP	E221
BYPASS STOP§♣▶	E298	HAND-O-AUTO ▶	E283	MAN-OFF-AUTO ▶	E259	REVERSE-FORWARD ▶	E189	UNCLAMP	E222
CLAMP	E106	HAND-AUTO ▶	E127	MANUAL-OFF-AUTO ▶	E157			UP	E223
CLOSE	E107	HAND-OFF-AUTO ▶	E128	MOTOR RUN	E158	REVERSE-OFF-FORWARD ▶	E190	UP-DOWN ▶	E224
CYCLE START	E108	HAND OFF	E264	MOTOR RUNNING	E159			UP-OFF-DOWN ▶	E225
DECREASE ▶	E109	HAND ON	E263	MOTOR START	E160	RIGHT	E191		
DRIVE-START ▶	E287	HAND START	E265	MOTOR STOP	E161	RIGHT-LEFT ▶	E192		
DRIVE-STOP ▶	E288	HAND STOP	E266	MOTOR STOPPED	E162	ROTATE CW	E246		
DOWN	E110	HEAT	E270	NO FLIP	E275	ROTATE CCW	E247		
DOWN-OFF-UP ▶	E111	HIGH	E129	OFF	E163	RUN	E193		
DRIVE ON§♣▶	E296	HIGH-LOW ▶	E130	OFF CIRCUIT	E244	RUN-JOG ▶	E194		
EMERG STOP	E251	HIGH-OFF-LOW ▶	E131	OFF-COOLANT-ON ▶	E164	RUN-SAFE-JOG ▶	E195		
EMERGENCY ▶	E248	IN	E132	OFF-LIGHT-ON ▶	E272	RUNNING	E243		
EMERGENCY OFF ▶	E294	IN-OUT ▶	E133	OFF-ON ▶	E165	SAFE	E196		
EMERGENCY STOP ▶	E112	INCH	E134	ON	E166	SAFE-RUN ▶	E197		
ENABLE	E279	INCH-REV ▶	E257	ON CIRCUIT	E245	SETUP	E198		
ENTER	E277	INCH-REVERSE ▶	E135	ON-OFF ▶	E167	SETUP-RUN ▶	E302		
ERROR	E273	INCH-RUN ▶	E136	ON-OFF-AUTO ▶	E168	SETUP-SERVICE ▶	E199		
EXHAUSTER ▶	E269	INCREASE ▶	E137	ON-STOP-SAFE ▶	E169	SEQUENCE-TEST ▶	E200		
FAULT	E113	INSPECT	E274	OPEN	E170	SLOW	E201		
FAST	E114	JOG	E138	OPEN-CLOSE ▶	E171	SLOWER	E202		
FAST-OFF-SLOW ▶	E289	JOG-FOR ▶	E255	OPEN-OFF-CLOSE ▶	E172	SLOWEST	E203		
FASTER	E115	JOG-FORWARD ▶	E139	OUT	E173	SLOW-FAST ▶	E204		
FEED START	E116	JOG-OFF-RUN ▶	E140	OVERLOAD ▶	E267	SLOW-OFF-FAST ▶	E205		
FEED STOP	E117	JOG-REV ▶	E256	OVERLOAD TRIP ▶	E174	SLOW-STOP-FAST ▶	E206		
FEEDER OFF	E118	JOG-REVERSE ▶	E141	OVERLOAD RESET ▶	E175	SLOW-OFF-START ▶	E207		
FEEDER ON	E119	JOG-RUN ▶	E142	POWER OFF	E177	SLOW SPEED	E291		
FIFO	E276	JOG-SAFE-RUN ▶	E143	POWER ON	E178	SOFT STOP	E292		
FOR-AUTO-REV ▶	E252	JOG-STOP-RUN ▶	E144	PULL TO START	E180	SPEED	E293		

* Items in grey shaded table cells only available on legend plates. Not available as laser-engraved text on button caps, illuminated push button diffusers, or pilot light diffusers.

※ Not available on -11 or -17 legend plates.

§ Not available on -34 legend plates.

♣ Not available on -35 legend plates.

▶ Not available on -42 legend plates.



Legend Texts, Continued
Standard Text, Continued*
French

Marking	Suffix No.	Marking	Suffix No.	Marking	Suffix No.	Marking	Suffix No.	Marking	Suffix No.
A-COUPS	F138	AVANT-ARRÊT-ARRIÈRE	F122	DESCENDRE	F110	HORS MANUEL	F249	MARCHE-ARRÊT	F211
ACCU-STOP	F280			DROIT	F191	LENT	F201	MONTER	F182
ARRIÈRE	F188	AVANT-ARRIÈRE	F124	EN	F247	LENT-ARRÊT-VITE	F205	OUVRIR	F170
ARRÊT	F163	AV-ARR	F290	EN CIRCUIT	F245	M FORCEE	F284	PANNE	F113
ARRÊT D'ENTR	F289	AV-HORS-ARR	F253	EN MANUEL	F250	MANUEL	F126	RAP-HORS-LENT	F285
ARRÊT DOUX	F288	BAS	F148	FERMER	F107	MANUEL-ARRÊT-AUTO	F128	RAPIDE	F114
ARRÊT D'URGENCE	F112	BAS-ARRÊT-HAUT	F150	FREINAGE	F105			RÉGLER	F198
ARRÊT-MANUEL	F251	DEMAR. D-ENTR	F283	GAUCHE	F145	MANUEL-AUTO	F127	SURCHARGE	F254
ARRÊT-MARCHE	F165	DEMAR.-MAN.	F252	HAUT	F129	MANUEL-HORS-AUTO	F157	VARIATEUR ALIMENTÉS	F293
ARRÊT POMPE	F286	DÉRIV-ARRÊT-EFN	F294	HAUT-HORS-BAS	F131			VIT. ATTEINT	F281
AUTO	F101	DÉRIV ARRÊT	F295	HORS	F246	MARCHE	F166	VIT. LENTE	F287
AUTO-MANUEL	F282	DÉRIV MARCHE	F296	HORS CIRCUIT	F244	—	—	VITESSE	F291
AVANT	F120	DÉRIVATION ALIMENTÉS	F292	HORS-EN	F248	—	—	—	—

Spanish

Marking	Suffix No.	Marking	Suffix No.	Marking	Suffix No.	Marking	Suffix No.	Marking	Suffix No.
ABRIR	S170	ARRANQUE	S166	DERECHA	S191	MARCHA	S208	PARADA-MARCHA	S165
ADELANTE	S120	ATRÁS	S188	EN SERVICIO	S243	MARCHA-PARO	S211	PARO	S163
ADELANTE-ATRÁS	S124	BAJADA	S152	IZQUIERDA	S145	PARADA	S212	SUBIDA	S182
ADELANTE-PARADA-ATRÁS	S123	BAJAR	S110	MANUAL	S126	PARADA DE EMERGENCIA	S112	SUBIR	S223
		CERRAR	S107	MANUAL-AUTO	S127			—	—

German

Marking	Suffix No.	Marking	Suffix No.	Marking	Suffix No.	Marking	Suffix No.	Marking	Suffix No.
AB	G110	EINRICHTEN	G198	LANGSAM	G201	ÖFFNEN	G170	VOR	G120
AUF	G223	HAND	G126	LINKS	G145	RECHTS	G191	VOR-AUS-ZURÜCK	G122
AUS	G163	HAND-AUS-AUTO	G128	LINKS-RECHTS	G146	SCHNELL	G114	VOR-ZURÜCK	G124
AUS-EIN	G165	HAND-AUTO	G127	NIEDRIG	G148	SENKEN	G152	ZU	G107
BETRIEB	G243	HEBEN	G182	NIEDRIG-AUS-HOCH	G150	STÖRUNG	G113	ZURÜCK	G188
EIN	G166	HOCH	G129	NOT AUS	G112	—	—	—	—

Italian

Marking	Suffix No.	Marking	Suffix No.	Marking	Suffix No.	Marking	Suffix No.	Marking	Suffix No.
ABBASSARE	T152	AVANTI-DISINS-INDIETRO	T122	DISCESA	T110	IN SERVIZIO	T243	MARCIA-ARRESTO	T211
ALTO	T129			DISINS-INS	T165	LENTO	T201	PREPARARE	T198
APRIRE	T223	AVANTI-INDIETRO	T124	DISINSERITO	T163	MANUALE	T126	RAPIDO	T114
ARRESTO	T212	BASSO	T148	DISTURBO	T113	MANUALE-AUTO	T127	ROTAZIONE CW	T246
ARRESTO EMERGENZA	T112	BASSO-DISINS-ALTO	T150	EMERGENZA	T248	MANUALE-DISINS-AUTO	T128	ROTAZIONE CCW	T247
		DESTRA	T191	INDIETRO	T188			SALITA	T182
AUTOMATICO	T101	CHIUDERE	T107	INSERITO	T166	MARCIA	T208	SINISTRA	T145
AVANTI	T120	—	—	—	—	—	—	—	—

Swedish

Marking	Suffix No.	Marking	Suffix No.	Marking	Suffix No.	Marking	Suffix No.	Marking	Suffix No.
BACK	N188	HÖGER	N191	NERN	110	UPP	N223	VÄNSTER	N145
FRAM	N120	—	—	—	—	—	—	—	—

* Items in grey shaded table cells only available on legend plates. Not available as laser-engraved text on button caps, illuminated push button diffusers, or pilot light diffusers.

§ Not available on -34 legend plates.

‡ Not available on -35 legend plates.

➤ Not available on -42 legend plates.

‡ Only available on legend plates and AD2 or AD4 diffusers.

22.5 mm Push Buttons

Approximate Dimensions

Approximate Dimensions

Dimensions in millimeters. Dimensions are not intended to be used for manufacturing purposes. Refer to RAISE software for additional dimensional information.

Non-Illuminated and Illuminated Momentary Flush Push Button Operators

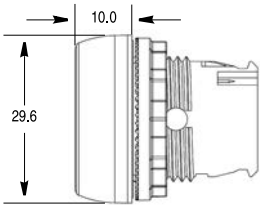

Illuminated Momentary Guarded Push Button Operators

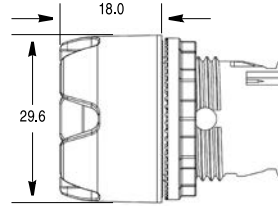

Illuminated and Non-Illuminated Momentary Extended Push Button Operators

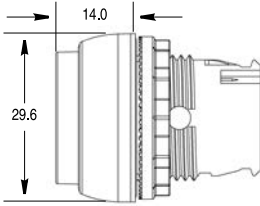

Reset Operators with Reset Rod

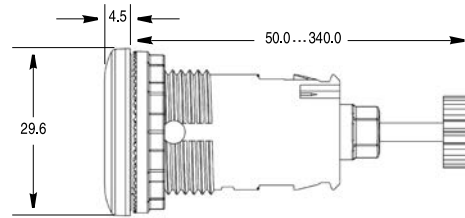

Non-Illuminated Guarded, Illuminated and Non-Illuminated Alternate Action Push Button Operators

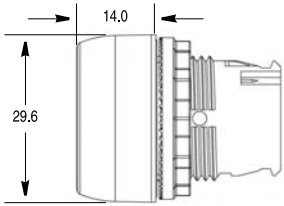

Pilot Light Operators

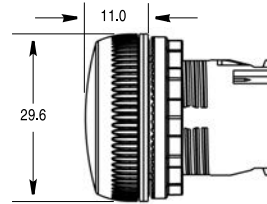

90 mm Half Dome

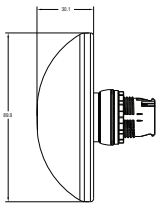

90 mm Mushroom

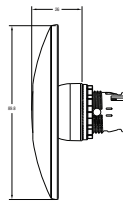

Illuminated and Non-Illuminated Momentary Mushroom Operators 40 mm and 60 mm

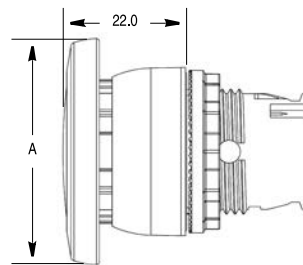

Operator	A
40 mm	39.8
60 mm	59.8

Toggle Switch Operators

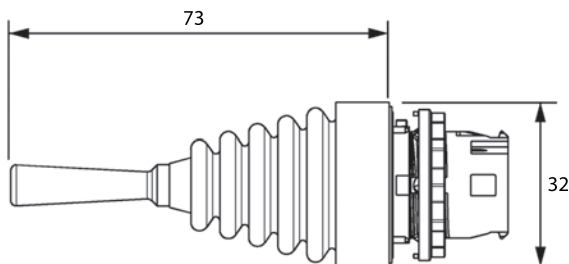

Selector Jog Operators

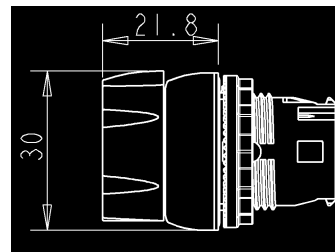

Dimensions in millimeters. Dimensions are not intended to be used for manufacturing purposes.

Illuminated and Non-Illuminated 2-Position Multi-Function Operators

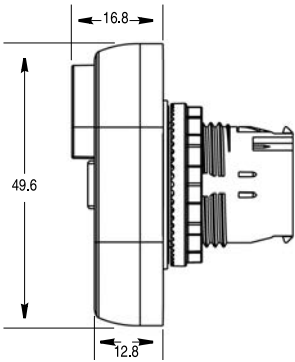

Non-Illuminated 3-Position Multi-Function Operators

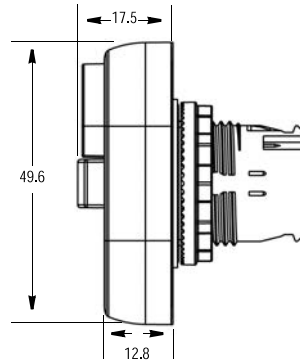

Potentiometer Operator

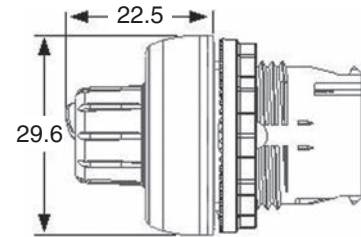

Illuminated and Non-Illuminated Knob Selector Switch Operators

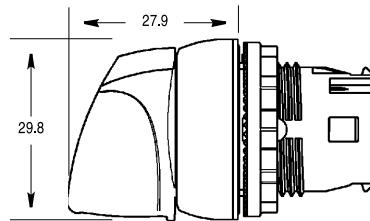

Non-Illuminated Knob Lever Selector Switch Operators

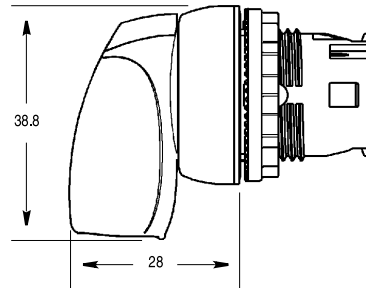

Illuminated and Non-Illuminated Twist-to-Release Operators 30 mm, 40 mm, and 60 mm

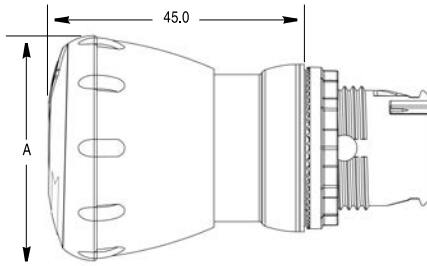

Illuminated and Non-Illuminated Push-Pull Mushroom Operators 30 mm, 40 mm, and 60 mm

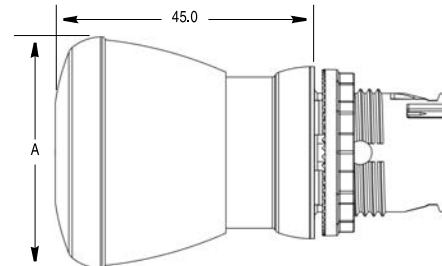

Operator	A
30 mm	30.0
40 mm	40.0
60 mm	60.0

Key Selector Switch and Key Ejected SensEject Operators

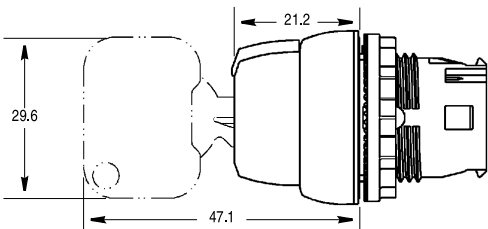

Mushroom Key Release Operator 40 mm

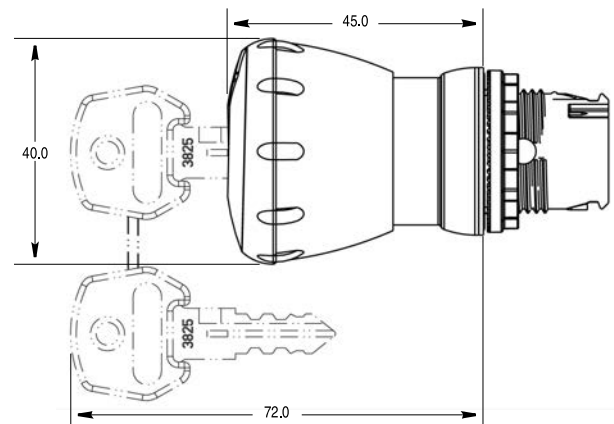

22.5 mm Push Buttons

Approximate Dimensions

Dimensions in millimeters. Dimensions are not intended to be used for manufacturing purposes.

**Back-of-Panel Components —
Incandescent Module with Latch**

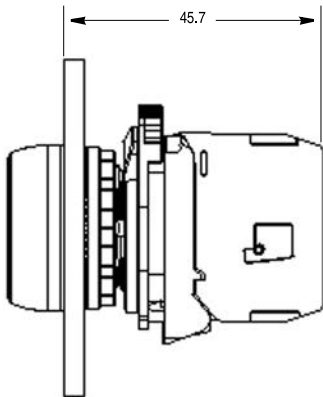

**Back-of-Panel Components —
LED Module with Latch**

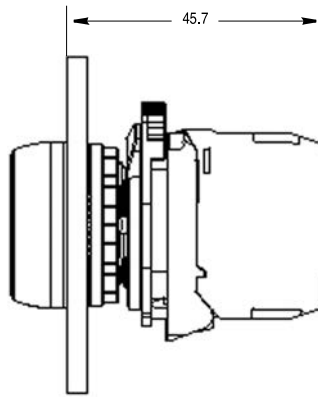

**Back-of-Panel Components —
Contact Cartridges with Latch**

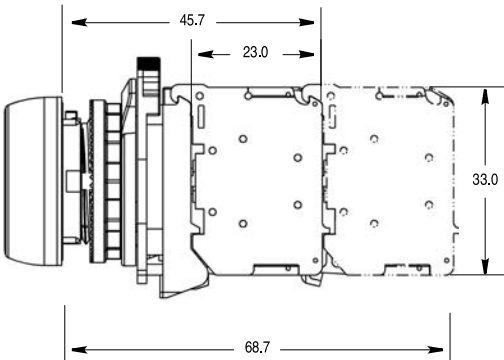

**Back-of-Panel Components —
Dual Circuit Contact Block or
Self Monitoring Contact Block
(Max. of 1 Deep)**

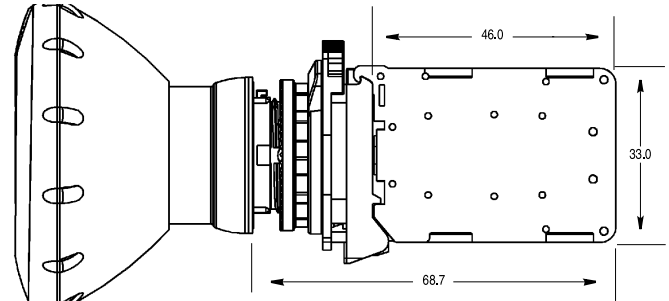

Potentiometer with Resistive Element

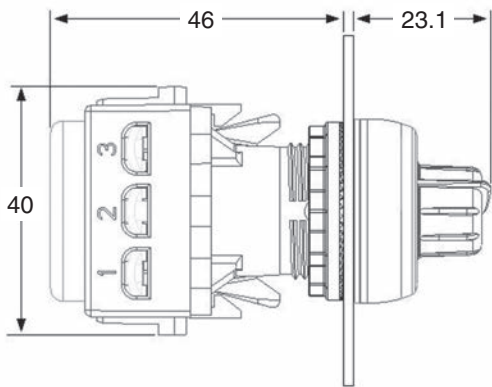

Customer Supplied Resistive Element

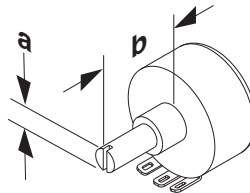

	Max.		Min.
a (Ø Dia.)	6.4 (0.252)	5.9 (0.232)	5.7 (0.224)
b (Length)	24 (0.945)	32 (1.26)	14 (0.551)

Dimensions in millimeters (inches).

10

30 x 40 mm Snap-In Legend Plate

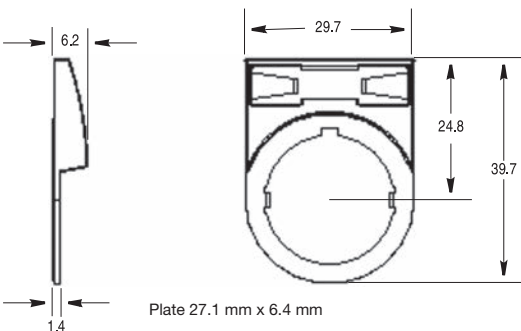

30 x 50 mm Snap-In Legend Plate

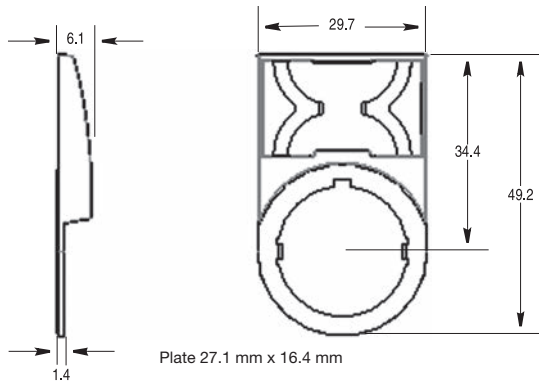

Dimensions in millimeters. Dimensions are not intended to be used for manufacturing purposes.

60 mm Round Legend — 15Y

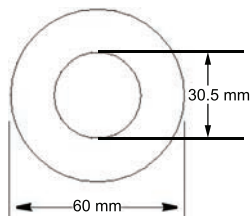

90 mm Round Legend

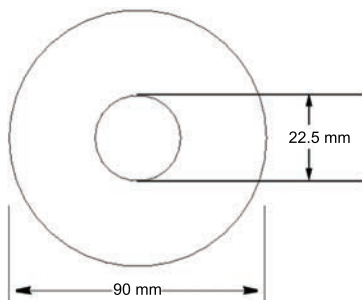

Trim Washer

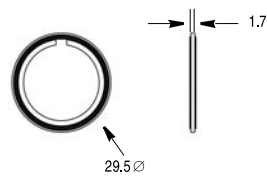

60 mm Round Legend — 15YS

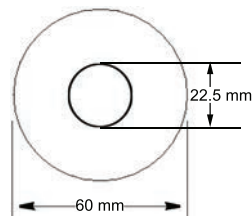

Potentiometer Legend Plate (Series A)

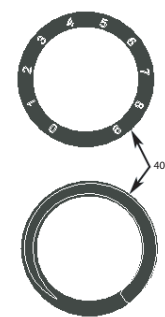

Anti-Rotation Washer

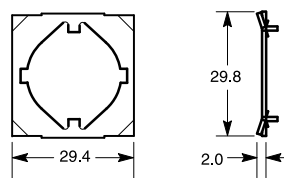

30 x 60 mm Snap-In Legend Plate

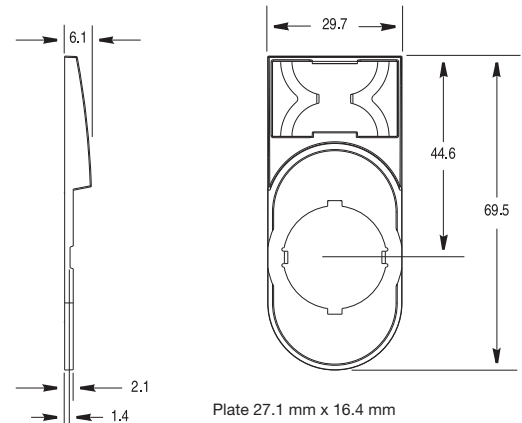

Special Multi-Function Snap-In Legend Plate

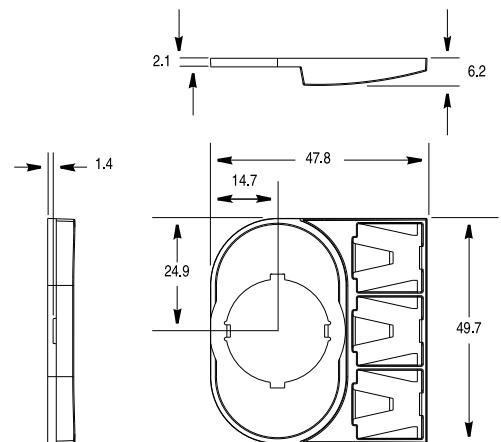

30 x 40 mm One-Piece Legend Plate

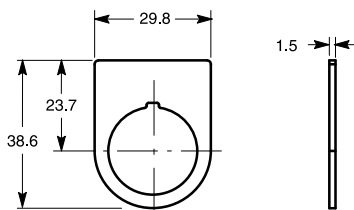

30 x 66 mm One-Piece Legend Plate

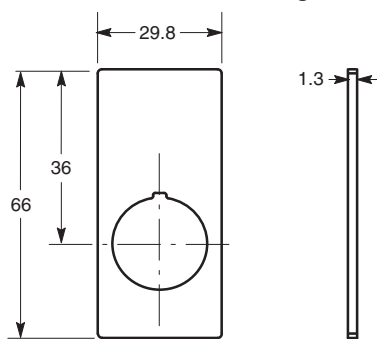

30 x 50 mm One-Piece Legend Plate

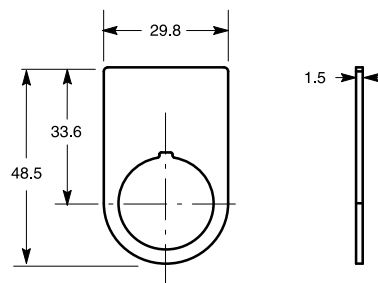

Hole Plug

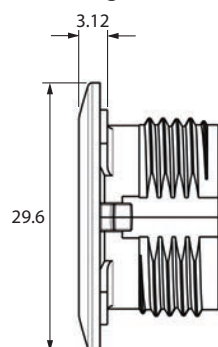

30 mm to 22.5 mm Hole Adapter

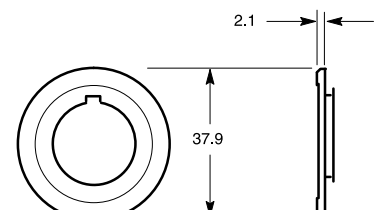

Base Mount Adapter

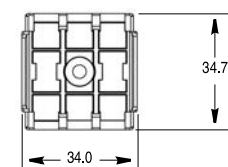
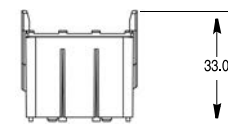

Note: Panel thickness range is 1.0...6.0 mm maximum.

Panel thickness reduced to 4 mm (standard anti-rotation washer) or 5 mm (thin anti-rotation washer) when optional legend plates are used.

22.5 mm Push Buttons

Approximate Dimensions

Dimensions in millimeters. Dimensions are not intended to be used for manufacturing purposes.

Locking Cover

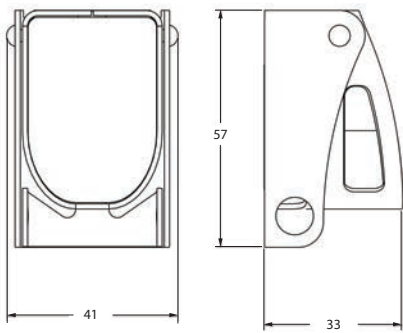

Maintained Mushroom Locking Attachment

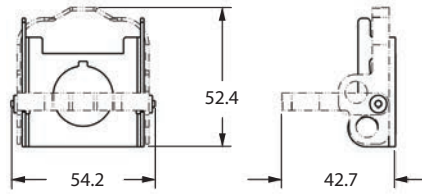

Momentary Mushroom Locking Attachment

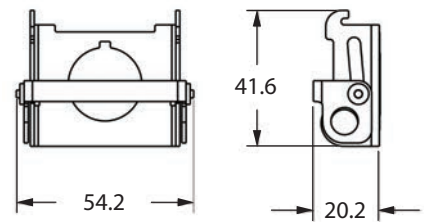

Extended Non-Illuminated Locking Attachment

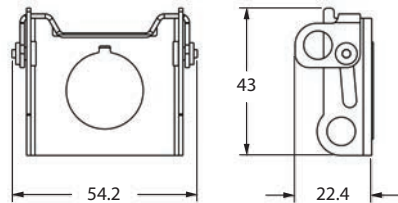

Flush Non-Illuminated Locking Attachment

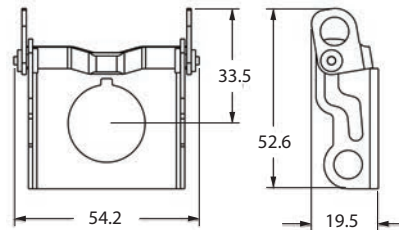

**Selector Switch Locking Cover
(Same for all Lock Positions)**

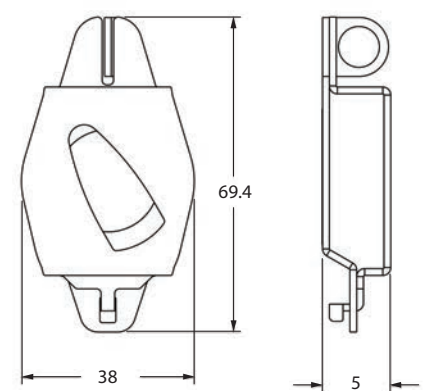

Narrow Guard

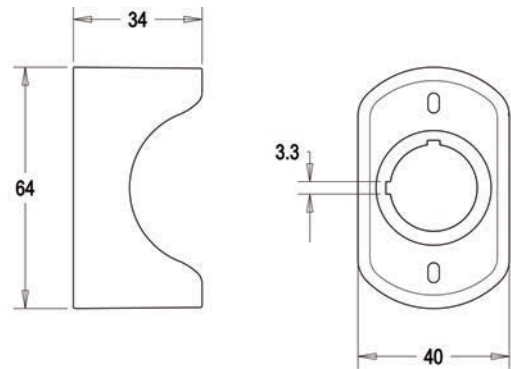

Protective Ring

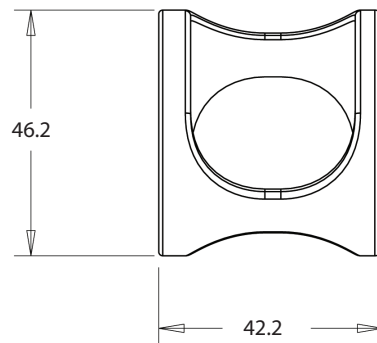

Plastic Guard

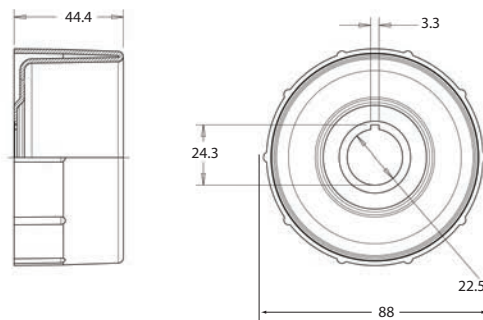

Dimensions in millimeters. Dimensions are not intended to be used for manufacturing purposes.

Plastic Enclosures*

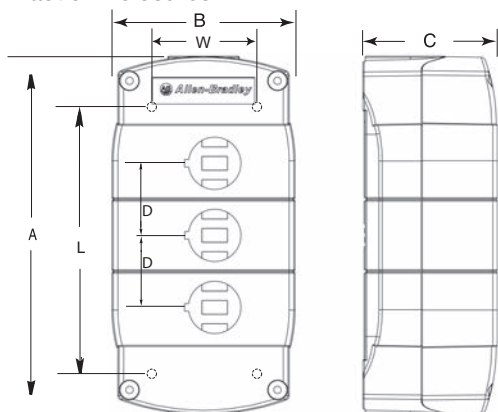

Cat. No.	No. of Holes	A	B	C	D	Mounting Holes	
						W	L
800F-1P*	1	85	89	58	—	58	59
800F-1Y*D		85	89	74	—	58	65
800F-2P*	2	124	79	58	31	48	102.5
800F-3P*	3	155	79	58	31	48	133
800F-4P*	4	186	79	58	31	48	164.5
800F-6P*	6	248	87	64	31	55	224

* Mounting screw — pan head with diameter ≤ 7 mm.

Metal Enclosures

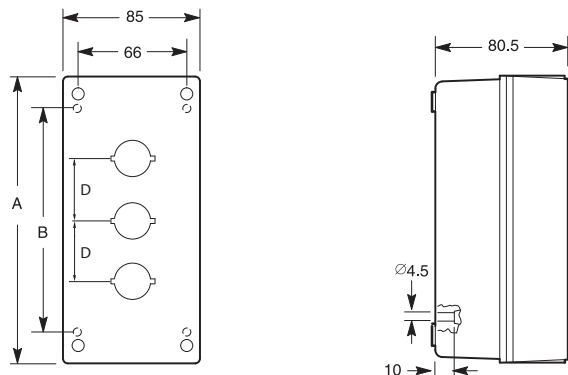

Cat. No.	No. of Units (Holes)	A	B	D
800F-1M*	1	99	62	—
800F-2M*	2	137	100	37.5
800F-3M*	3	174	137	37.5
800F-5M*	5	249	212	37.5

* P = PG conduit holes or M = Metric conduit holes

Pendant Stations

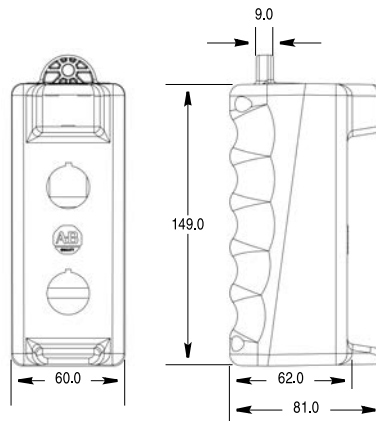

Note: Cable opening = 21.2 mm diameter

Instruction Sheet

OPTIONAL EN OPTION
 OPTIONAL PLASTIC
 OPZIONALE

PLASTIC
 PLASTIK
 PLÁSTICO
 PLÁSTICA
 1.7 Nm
 15 lb-in

METAL
 METALL
 METAL
 METALLO
 4.4 Nm
 40 lb-in

7 mm
 0.75 - 1.5 mm*
 (#18 - #12 AWG)

0.6 mm 1.35 mm
 1.8 mm
 1.4 mm
 1- 4.8 mm
 1- 2.8 mm
 1- 6 mm
 1- 4 mm
 0.75 - 2.5 mm*
 (#18 - #12 AWG)
 0.7 - 0.9 Nm
 6 - 8 lb-in

1.2 Nm
 10 lb-in

Ø4.5
 10

40 50 40 50 40/60 50/60 60/90 70 50
 30 48 40/60 30 50

EMERGENCY STOP
 Ø60, Ø90

22.5 mm Push Buttons

Approximate Dimensions

Assembled Station Pin Out Chart

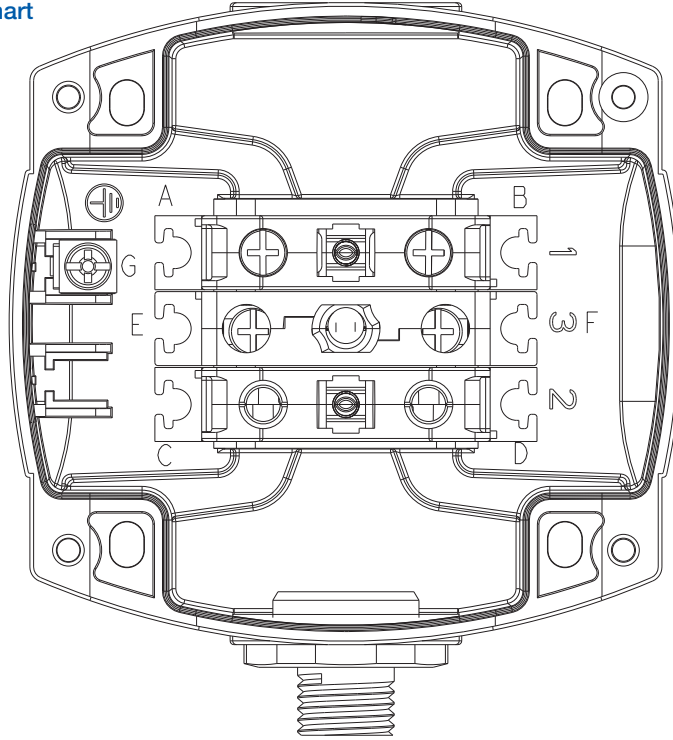

Cat. No.	Connector Style / No. of Pins	Location 1	A to Pin #	B to Pin #	Location 2	C to Pin #	D to Pin #	Location 3	E to Pin #	F to Pin #	G to Pin #
800F-1YMQ53V	AC Micro / 5-pin	BX01V	1	2	BX01V	4	5	—	—	—	3
800F-1YMQA	AC Micro / 6-pin	BX01	1	5	BX01	2	6	BX10	3	4	—
800F-NX1	DC Micro / 4-pin	BX01	1/4	2/3	—	—	—	—	—	—	—
800F-1YMQ1		BX01	1/4	2/3	—	—	—	—	—	—	—
800F-1YMQ2		BX10V	2	4	BX01V	1	3	—	—	—	—
800F-1YMQ3		BX01V	1	3	BX01V	2	4	—	—	—	—
800F-1YMQ3VEG		BX01V	1	3	BX01V	2	4	—	—	—	—
800F-1YMQ3V		DC Micro / 5-pin	BX01V	1	2	BX01V	4	5	—	—	—
800F-1YMQ41	Mini Receptacle / 4-pin	BX01	2	4	—	—	—	—	—	—	—
800F-1YMQ44		BX10	1	J	BX01	2	4	BN3R	3	J	J
800F-1YMQ4	Mini Receptacle / 6-pin	BX10	1	J	BX01	6	5	BN3R	2	J	J
800F-1YMQ5		BX10	1	J	BX01	6	5	BN5R	2	J	J
800F-1YMQ6		BX10	1	J	BX01	6	5	BN7R	2	J	J
800F-1MYMQ4		BX10	1	J	BX01	6	5	BN3R	2	J	J
800F-1MYMQ5		BX10	1	J	BX01	6	5	BN5R	2	J	J
800F-1MYMQ6		BX10	1	J	BX01	6	5	BN7R	2	J	J

J = Jumper



Bulletin 800FC — Configured Pendant Stations

- 3-, 5-, 7-, and 9-button configurations
- 1-, 2-, and 3-speed push buttons
- IP66, NEMA Type 4/4X/13
- Finger-safe contact blocks
- Buttons are flush-mounted with the enclosure to reduce accidental operation
- Use of standard Bul. 800F extended push buttons
- Electrical and mechanical interlocks

Bulletin 800FP — 1-, 2-, and 3-Speed Operators

- IP65/IP66, NEMA Type 4/4X/13
- Engineering grade thermoplastics
- Chemical-resistant for harsh environments
- Booted operator

Mechanical Interlock

- 1-, 2-, and 3-speed operators
- Screw-down mounting
- 3-across x 1 deep contact blocks
- Snap-down contact blocks
- Bifurcated and Quad Connect contact blocks
- Color-coded contact blocks

Table of Contents

Product Selection 10-128
 Catalog Number
 Explanation 10-132
 Accessories..... 10-134
 Specifications..... 10-136
 Approximate
 Dimensions * 10-138

Product Certifications

Certifications	UR/UL, CSA, CCC, CE
Standards Compliance	NEMA ICS-5, UL 508, CSA C22.2 No. 14, EN ISO 13850, EN 60947-1, EN 60947-5-1, EN 60947-5-5
Terminal Identification	EN/IEC 60947-1
RoHS	✓

Operator Mounting - Vertical vs. Horizontal Definition

Due to the design of the enclosures, operators are mounted in both a vertical and horizontal orientation. The easiest way to visualize the operator orientation is by observing the contact block direction attached to the operators. If the contact blocks are mounted vertically the operator is mounted vertically in the enclosure. Vertical mounted operators are only found in position 2 & 3 of the 3-hole enclosure. If the contact blocks are mounted horizontally the operator is mounted horizontally in the enclosure. Horizontal mounted operators are found in position 1 of the 3-hole enclosure and all positions of the 5-...9-hole enclosures. It is necessary to know this when ordering individual operators for populating at the customer location.

Operator Sequence when using a Mechanical Interlock

The 1-, 2-, and 3-speed operators can be mounted with either our standard **Cat. No. 800F-ALP** latch or a mechanical interlocking latch (**Cat. No. 800FC-ALP**). For the 3-hole enclosure, the mechanical interlock can only be located in positions 2 & 3, with the black operator being located in position 2 and the white operator being located in position 3. For the 5-...9-hole enclosures, the mechanical interlock can be located in any two adjacent positions. For the 5-...9-hole enclosures, the white operator will be located in position X of the mechanical interlock and the black operator will be located in position X+1 of the mechanical interlock.

Operator Assembly Sequence and Mounting Orientation

Vertical Mount Operators

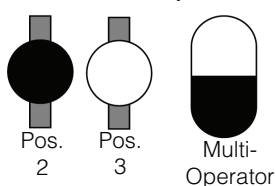

Horizontal Mount Operators

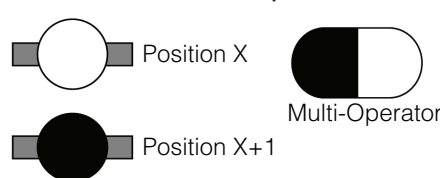

3-Hole Enclosure*



5-Hole Enclosure*

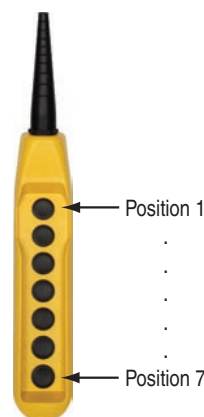

7-Hole Enclosure*

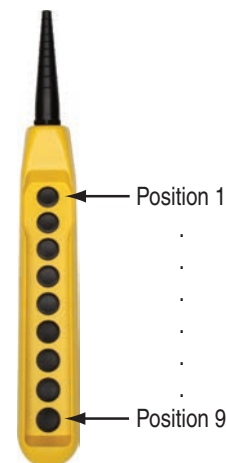

9-Hole Enclosure*

* Operator in Position 1 is mounted horizontal, contact blocks are horizontal. Operators in Positions 2 & 3 are mounted vertical, contact blocks are vertical.
 * Operators in all positions are mounted horizontal, contact blocks are horizontal.

Bulletin 800FC
22.5 mm Configured Pendant Stations
 Product Selection

Product Selection
 Enclosures

Enclosure Type	Pkg. Quantity	Pendants — Yellow Plastic IP66 Cat. No.*
3-hole	1	800FC-3Z
5-hole		800FC-5Z
7-hole		800FC-7Z
9-hole		800FC-9Z

* Housings supplied with cable sleeve, hanger ring, cable clamp, wire guides, and gasket.



Cat. No. 800FC-3Z



Cat. No. 800FC-7Z

1-, 2-, and 3-Speed Operators §*

800FP - C A 1 U243
 a b c



a

Operator Type	
Code	Description
A	1-speed single arrow
D	1-speed double arrow
B	2-speed
C	3-speed*

* Proper contact block assembly of these devices is required. Please see contact block information on page 104.

b

Cap Color	
Code	Description
1	White
2	Black

Arrow Direction Chart

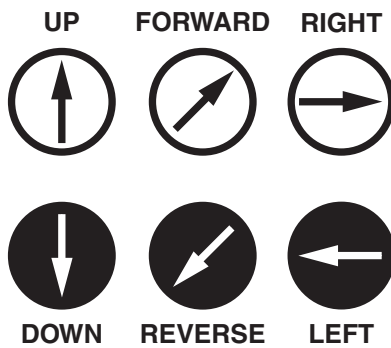

c

Code	Valid with Table a Selections:	Symbol Description‡				
		Vertical Mounting		Horizontal Mounting		
		Black with White Arrow	White with Black Arrow	White with Black Arrow	Black with White Arrow	
U100	A, B, C	Blank	Blank	Blank	Blank	
One-Speed Operators						
	A	U241	DOWN	UP	—	—
		U243	—	—	RIGHT	LEFT
		U244	REVERSE	FORWARD	—	—
		U246	—	—	FORWARD	REVERSE
		U700	LEFT	RIGHT	UP	DOWN
	D	U261	DOWN FAST	UP FAST	—	—
		U263	—	—	RIGHT FAST	LEFT FAST
		U264	REVERSE FAST	FORWARD FAST	—	—
		U266	—	—	FORWARD FAST	REVERSE FAST
		U260	LEFT FAST	RIGHT FAST	UP FAST	DOWN FAST
Two-Speed Operators						
	B	U271	2-speed DOWN	2-speed UP	—	—
		U273	—	—	2-speed RIGHT	2-speed LEFT
		U274	2-speed REVERSE	2-speed FORWARD	—	—
		U276	—	—	2-speed FORWARD	2-speed REVERSE
		U270	2-speed LEFT	2-speed RIGHT	2-speed UP	2-speed DOWN
Three-Speed Operators						
	C	U291	3-speed DOWN	3-speed UP	—	—
		U293	—	—	3-speed RIGHT	3-speed LEFT
		U294	3-speed REVERSE	3-speed FORWARD	—	—
		U296	—	—	3-speed FORWARD	3-speed REVERSE
		U290	3-speed LEFT	3-speed RIGHT	3-speed UP	3-speed DOWN

Note: Please see page 104 for proper latch and contact block configurations.

‡ Text (DOWN, UP, LEFT, etc.) indicates arrow direction. Text is **not** printed on operators.

§ Cat. No. 800F-ALP (standard latch) and Cat. No. 800FC-ALP (mechanical interlock latch) can be used with these operators.

* Booted style of operators for pendant stations.

Bul. 800F Two-Position Twist-to-Release and Twist-to-Release/Push-Pull Operators



Description	Operator Cat. No.	Guard Cat. No.
Twist-to-release — Red	800FP-MT44PX01	—
Twist-to-release — Red, illuminated	800FP-LMT44PN§RX01	—
Keyed twist-to-release — Red	800FP-MK44PX01	—
Twist-to-release or push-pull — Red, monolithic	800FD-MT44X01	—
Twist-to-release or push-pull — Red, monolithic with guard, monolithic	800FD-MT44X01	800F-AMEGY

§ Select **3** for 24V AC/DC or **5** for 120V AC.

Bul. 800F Push Button Operators and Caps — Extended & Non-Illuminated *



Cap Color	Description	Symbol Definition	Operator Cat. No.	Cap Cat. No.	Complete Operator Cat. No.	Composite Cat. No./ No Electrical Interlock*	Composite Cat. No./ Electrical Interlock*
Black	Blank	—	800FP-E2	—	—	800FP-E2PX10	800FP-E2PX11
	LEFT or DOWN	Single arrow 0°	800FP-E9	800F-AE208	800FP-E208	800FP-E208PX10	800FP-E208PX11
	REVERSE	Single arrow 45°		800F-AE2CU244	800FP-E2U244	800FP-E2U244PX10	800FP-E2U244PX11
	LEFT FAST or DOWN FAST	Double arrow 0°		800F-AE2CU261	800FP-E2U261	800FP-E2U261PX10	800FP-E2U261PX11
REVERSE FAST	Double arrow 45°	800F-AE2CU264		800FP-E2U264	800FP-E2U264PX10	800FP-E2U264PX11	
White	Blank	—	800FP-E1	—	—	800FP-E1PX10	800FP-E1PX11
	UP or RIGHT	Single arrow 0°	800FP-E9	800F-AE108	800FP-E108	800FP-E108PX10	800FP-E108PX11
	FORWARD	Single arrow 45°		800F-AE1CU244	800FP-E1U244	800FP-E1U244PX10	800FP-E1U244PX11
	UP FAST or RIGHT FAST	Double arrow 0°		800F-AE1CU261	800FP-E1U261	800FP-E1U261PX10	800FP-E1U261PX11
FORWARD FAST	Double arrow 45°	800F-AE1CU264		800FP-E1U264	800FP-E1U264PX10	800FP-E1U264PX11	
Green	Blank	—	800FP-E3	—	—	800FP-E3PX10	—
	START/ALARM	Start/Alarm	800FP-E9	800F-AE3CU222	800FP-E3U222	800FP-E3U222PX10	
START	Start symbol	800F-AE3CU909		800FP-E3U909	800FP-E3U909PX10		
Red	Blank	—	800FP-E4	—	—	800FP-E4PX10	
	STOP	Stop symbol	800FP-E9	800F-AE405	800FP-E405	800FP-E405PX10	
Yellow	Blank	—	800FP-E5	—	—	800FP-E5PX10	
	ALARM	Alarm	800FP-E9	800F-AE5CU223	800FP-E5U223	800FP-E5U223PX10	
Blue	Blank	—	800FP-E6	—	—	800FP-E6PX10	
	R	Reset symbol	800FP-E9	800F-AE611	800FP-E611	800FP-E611PX10	

* For 24V AC/DC units, add **V** for low voltage contact blocks. Example: **Cat. No. 800FP-E5PX10** becomes **Cat. No. 800FP-E5PX10V**.

* Mechanical interlock is not allowed.

Bul. 800F Push Button Operators — Extended & Illuminated *



Lens Color	Operator Cat. No.	Composite Cat. No.
Green	800FP-LE3	800FP-LE3PN§GX10
Red	800FP-LE4	800FP-LE4PN§RX10
Yellow	800FP-LE5	800FP-LE5PN§WX10
Blue	800FP-LE6	800FP-LE6PN§BX10
Clear	800FP-LE7	800FP-LE7PN§WX10

§ Select **3** for 24V AC/DC or **5** for 120V AC.

* Mechanical interlock is not allowed.

Bul. 800F Selector Switch Operators — Maintained & Non-Illuminated



Number of Positions	Keyed	Operator Cat. No.	Composite Cat. No.*
	2	No	800FP-SM22
Yes		800FP-KM21	800FP-KM21PX11
3	No	800FP-SM32	800FP-SM32PX20
	Yes	800FP-KM34	800FP-KM34PX20

* For 24V AC/DC units, add **V** for low voltage contact blocks. Example: **Cat. No. 800FP-E5PX10** becomes **Cat. No. 800FP-E5PX10V**.

Bulletin 800FC
22.5 mm Configured Pendant Stations
 Product Selection

Bul. 800F Multi Operators and Caps— Extended ‡*

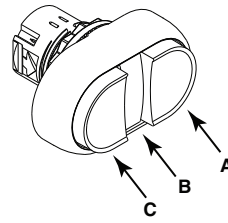
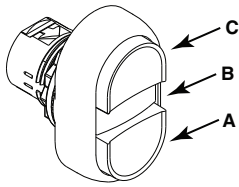

Vertical Mounting

Horizontal Mounting

Description	Symbol Definition	Illumination	Operator Cat. No.	Position A Cap Cat. No.	Position C Cap Cat. No.	Back of Panel Cat. No.*
Blank (black and white cap)	—	Non-Illuminated	800FP-U2X	800F-AEU2	800F-AEU1	800F-PX20
		Illuminated	800FP-LU2X			800F-PN§WX20

Vertical Mounting

UP (white)/DOWN (black)	Single arrow 0°	Non-Illuminated	800FP-U2X	800F-AECU2CU241	800F-AECU1CU241	800F-PX20
		Illuminated	800FP-LU2X			800F-PN§WX20
RIGHT (white)/LEFT (black)	Single arrow 90°	Non-Illuminated	800FP-U2X	800F-AECU2CU700	800F-AECU1CU700	800F-PX20
		Illuminated	800FP-LU2X			800F-PN§WX20
FORWARD (white)/REVERSE (black)	Single arrow 45°	Non-Illuminated	800FP-U2X	800F-AECU2CU244	800F-AECU1CU244	800F-PX20
		Illuminated	800FP-LU2X			800F-PN§WX20
UP FAST (white)/DOWN FAST (black)	Double arrow 0°	Non-Illuminated	800FP-U2X	800F-AECU2CU261	800F-AECU1CU261	800F-PX20
		Illuminated	800FP-LU2X			800F-PN§WX20
RIGHT FAST (white)/LEFT FAST (black)	Double arrow 90°	Non-Illuminated	800FP-U2X	800F-AECU2CU260	800F-AECU1CU260	800F-PX20
		Illuminated	800FP-LU2X			800F-PN§WX20
FORWARD FAST (white)/REVERSE FAST (black)	Double arrow 45°	Non-Illuminated	800FP-U2X	800F-AECU2CU264	800F-AECU1CU264	800F-PX20
		Illuminated	800FP-LU2X			800F-PN§WX20

Horizontal Mounting

LEFT (black)/RIGHT (white)	Single arrow 90°	Non-Illuminated	800FP-U2X	800F-AECU1CU241	800F-AECU2CU241	800F-PX20
		Illuminated	800FP-LU2X			800F-PN§WX20
DOWN (black)/UP (white)	Single arrow 0°	Non-Illuminated	800FP-U2X	800F-AECU1CU242	800F-AECU2CU242	800F-PX20
		Illuminated	800FP-LU2X			800F-PN§WX20
REVERSE (black)/FORWARD (white)	Single arrow 45°	Non-Illuminated	800FP-U2X	800F-AECU1CU245	800F-AECU2CU245	800F-PX20
		Illuminated	800FP-LU2X			800F-PN§WX20
LEFT FAST (black)/UP FAST (white)	Double arrow 90°	Non-Illuminated	800FP-U2X	800F-AECU1CU261	800F-AECU2CU261	800F-PX20
		Illuminated	800FP-LU2X			800F-PN§WX20
DOWN FAST (black)/UP FAST (white)	Double arrow 0°	Non-Illuminated	800FP-U2X	800F-AECU1CU262	800F-AECU2CU262	800F-PX20
		Illuminated	800FP-LU2X			800F-PN§WX20
REVERSE FAST (black)/FORWARD FAST (white)	Double arrow 45°	Non-Illuminated	800FP-U2X	800F-AECU1CU265	800F-AECU2CU265	800F-PX20
		Illuminated	800FP-LU2X			800F-PN§WX20

§ Select **3** for 24V AC/DC or **5** for 120V AC.

* For 24V AC/DC units, add **V** for low voltage contact blocks. Example: **Cat. No. 800F-PX20** becomes **Cat. No. 800F-PX20V**

‡ Electrical interlock cannot be performed within the pendant enclosure.

* Mechanical interlock is not allowed.

22.5 mm Configured Pendant Stations

Product Selection

Bul. 800F Pilot Lights — Monolithic



Lens Color	Lamp Voltage	Cat. No.
Green	24V AC/DC	800FD-P3N3
	120V AC	800FD-P3N5
Red	24V AC/DC	800FD-P4N3
	120V AC	800FD-P4N5
Yellow	24V AC/DC	800FD-P5N3
	120V AC	800FD-P5N5
Blue	24V AC/DC	800FD-P6N3
	120V AC	800FD-P6N5
Clear	24V AC/DC	800FD-P7N3
	120V AC	800FD-P7N5

Bul. 800F Potentiometer Operators*



Resistive Element (Ω)	Cat. No.
150	800FP-POT1
500	800FP-POT2
1000	800FP-POT3
2500	800FP-POT4
5000	800FP-POT5
10 000	800FP-POT6

* Only available in Position 1 for a 3-hole enclosure, Positions 1 and/or 5 for a 5-hole enclosure, Positions 1 and/or 7 for a 7-hole enclosure, and positions 1 and/or 9 for a 9-hole enclosure. No latches are required.

Bul. 800F Hole Plug



Color	Cat. No.
Black plastic	800F-N2

1-, 2-, and 3-Speed Contact Block Assemblies

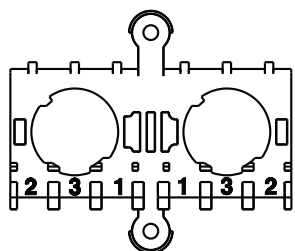

Cat. No. **800FC-ALP**

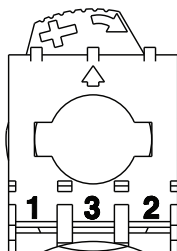

Cat. No. **800F-ALP**

Operator Type	Interlock Type	Composite Cat. No.	Separate Catalog Numbers			
			Latch Cat. No.	Contact Block Location 1 Cat. No.	Contact Block Location 2 Cat. No.	Contact Block Location 3 Cat. No.
1-speed	No interlock	800F-PX10E	800F-ALP	—	—	800F-X10E
	Electrical interlock	800F-PX11C	800F-ALP	800F-X01B		
	Mechanical interlock§	800F-LX20C	800FC-ALP	—		
2-speed	Electrical & mechanical interlock§	800F-LX22C	800FC-ALP	800F-X01B	800F-X10N (Speed 2)	800F-X10E (Speed 1)
	No interlock	800F-PX20C	800F-ALP	—		
	Electrical interlock	800F-PX21C	800F-ALP	800F-X01B		
	Mechanical interlock§	800F-LX40C	800FC-ALP	—		
3-speed	Electrical & mechanical interlock§	800F-LX42C	800FC-ALP	800F-X01B	800F-X10E (Speed 2)	800F-X10M (Speed 1)‡
	No interlock	800F-PX30C	800F-ALP	800F-X10N		
	Mechanical interlock§	800F-LX60C	800FC-ALP	800F-X10N (Speed 3)		

⊛ Contact blocks come preassembled onto latch.

‡ For proper operation, **Cat. No. 800F-X10M** must be mounted in position 3 of either the mechanical or standard latch.

§ When ordering separate components, two pieces of each contact block must be ordered, one for each operator.

Bulletin 800FC
22.5 mm Configured Pendant Stations
 Catalog Number Explanation

Catalog Number Explanation
 Configured Pendant Stations

800FC –

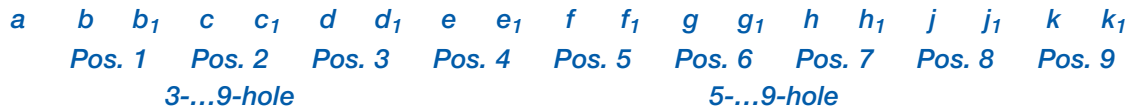

Note: A code from Tables *b...k* and *b₁...k₁* must be specified for each operator to create a valid cat. no.

a

Enclosure Code					
Voltage	Legend Plate	3-Hole	5-Hole	7-Hole	9-Hole
		Code	Code	Code	Code
24V AC/DC	No	2	4	6	8
120V AC		3	5	7	9
24V AC/DC	Yes	A	C	E	G
120V AC		B	D	F	H

b...k

Operator Type		
Single Speed Operators for use with Mechanical Interlock†+‡11		
Code	Description	Legend Plate Text (When Selected)
A2	Black operator (no text or symbol)	Blank
AB	Black operator with arrow (reverse — down/left)	O/H CRANE, REVERSE
AD	Black operator with arrow (down)	LIFT, DOWN
AL	Black operator with arrow (left)	HOIST, LEFT
A1	White operator (no text or symbol)	Blank
AF	White operator with arrow (forward — up/right)	O/H CRANE, FORWARD
AR	White operator with arrow (right)	HOIST, RIGHT
AU	White operator with arrow (up)	LIFT, UP
Fast Single Speed Operators for use with Mechanical Interlock†+‡11		
Code	Description	Legend Plate Text (When Selected)
DB	Black operator with double arrow (reverse fast — down/left)	O/H CRANE, REVERSE, FAST
DD	Black operator with double arrow (down fast)	LIFT, DOWN FAST
DL	Black operator with double arrow (left fast)	O/H CRANE, LEFT FAST
DF	White operator with double arrow (forward fast — up/right)	O/H CRANE, FORWARD, FAST
DR	White operator with double arrow (right fast)	O/H CRANE, RIGHT FAST
DU	White operator with double arrow (up fast)	LIFT, UP FAST
Two-Speed Operators for use with Mechanical Interlock†+‡11		
Code	Description	Legend Plate Text (When Selected)
B2	Black operator (no text or symbol)	Blank
BB	Black operator with arrow (reverse — down/left)	1-2 SPEED, O/H CRANE, REVERSE
BD	Black operator with arrow (down)	1-2 SPEED, LIFT, DOWN
BL	Black operator with arrow (left)	1-2 SPEED, HOIST, LEFT
B1	White operator (no text or symbol)	Blank
BF	White operator with arrow (forward — up/right)	1-2 SPEED, O/H CRANE, FORWARD
BR	White operator with arrow (right)	1-2 SPEED, HOIST, RIGHT
BU	White operator with arrow (up)	1-2 SPEED, LIFT, UP
Three-Speed Operators for use with Mechanical Interlock†‡\$+‡11		
Code	Description	Legend Plate Text (When Selected)
C2	Black operator (no text or symbol)	Blank
CB	Black operator with arrow (reverse — down/left)	1-2-3 SPEED, O/H CRANE, REVERSE
CD	Black operator with arrow (down)	1-2-3 SPEED, LIFT, DOWN
CL	Black operator with arrow (left)	1-2-3 SPEED, HOIST, LEFT
C1	White operator (no text or symbol)	Blank
CF	White operator with arrow (forward — up/right)	1-2-3 SPEED, O/H CRANE, FORWARD
CR	White operator with arrow (right)	1-2-3 SPEED, HOIST, RIGHT
CU	White operator with arrow (up)	1-2-3 SPEED, LIFT, UP

* Only available in position 1 of a 3-hole enclosure and in positions 1 & 2 of a 5-...9-hole enclosure.

‡ Monolithic style device provided.

† For a 3-hole enclosure, when a mechanical interlock (c1 & d1 = M or B) is selected with a 1-...3-speed operator, the black operator will be located in position 2 of the enclosure and the opposite white operator will be placed in position 3 of the enclosure (Example: ABMAFM or BDMBUM). For a 5-...9-hole enclosure, when a mechanical interlock (b1...k1 = M or B) is selected with a 1-...3-speed operator, the white operator will be located in position X of the mechanical interlock and the opposite black operator will be placed in position X+1 of the mechanical interlock (Example: AFMABM or BUMBDM).

§ Interlock and/or rubber boot selection = N (no interlock, no additional boots) is **not** allowed.

‡ Interlock and/or rubber boot selection = E (electrical interlock, no additional boots) is **not** allowed.

➤ Interlock and/or rubber boot selection = M (mechanical interlock) is **not** allowed.

‡ Interlock and/or rubber boot selection = B (electrical and mechanical interlock) is **not** allowed.

† Interlock and/or rubber boot selection = R (no interlock, additional rubber boot) is **not** allowed.

‡ Interlock and/or rubber boot selection = S (electrical interlock, additional rubber boot) is **not** allowed.

▲ Only available in position 1 for a 3-hole enclosure, positions 1 and/or 5 for a 5-hole enclosure, positions 1 and/or 7 for a 7-hole enclosure, and positions 1 and/or 9 for a 9-hole enclosure.

11 For proper installation, a trim washer or Cat. No. 800F-36_ legend plate must be installed with this operator.

b₁...k₁

Interlock and/or Rubber Boot	
Code	Description
N	No interlock, no additional boots
E	Electrical interlock, no additional boots
M	Mechanical interlock, boots standard†
B	Electrical and mechanical interlock, boots standard†
R	No interlock, additional rubber boot
S	Electrical interlock, additional rubber boot

22.5 mm Configured Pendant Stations

Catalog Number Explanation

b...k, continued

Operator Type		
Emergency Stop Operators*->⊗+⊕		
Code	Description	Legend Plate Text (When Selected)
MT	Red operator — twist-to-release	Not provided
ME	Illuminated red operator — twist-to-release	
MK	Red operator — keyed twist-to-release	
MM	Red operator — twist-to-release/push-pull⊗	
MG	Red operator with guard — twist-to-release/push-pull⊗	
Standard Extended Push Buttons — Non-Illuminated>⊗		
Code	Description	Legend Plate Text (When Selected)
E2	Black operator (no text or symbol)	Blank
ED	Black operator with arrow (down)	LIFT, DOWN
EL	Black operator with arrow (left)	HOIST, LEFT
EB	Black operator with arrow (reverse — down/left)	O/H CRANE, REVERSE
FD	Black operator with double arrow (down fast)	LIFT, DOWN FAST
FL	Black operator with double arrow (left fast)	O/H CRANE, LEFT FAST
FB	Black operator with double arrow (reverse fast — down/left)	O/H CRANE, REVERSE, FAST
E1	White operator (no text or symbol)	Blank
EU	White operator with arrow (up)	LIFT, UP
ER	White operator with arrow (right)	HOIST, RIGHT
EF	White operator with arrow (forward — up/right)	O/H CRANE, FORWARD
FU	White operator with double arrow (up fast)	LIFT, UP FAST
FR	White operator with double arrow (right fast)	O/H CRANE, RIGHT FAST
FF	White operator with double arrow (forward fast — up/right)	O/H CRANE, FORWARD, FAST
E3	Green operator (no text or symbol)*⊕	Blank
EQ	Green operator with Start/Alarm symbol*⊕	START, ALARM
EN	Green operator with Start symbol*⊕	START
E4	Red operator (no text or symbol)*⊕	Blank
ES	Red operator with Stop symbol*⊕	STOP
E5	Yellow operator (no text or symbol)*⊕	Blank
EA	Yellow operator with Alarm symbol*⊕	ALARM
E6	Blue operator (no text or symbol)*⊕	Blank
R6	Blue operator with R*⊕	RESET
Standard Extended Push Buttons — Illuminated*->⊗+⊕		
Code	Description	Legend Plate Text (When Selected)
L3	Green operator (no text or symbol)	Blank
L4	Red operator (no text or symbol)	Blank
L5	Yellow operator (no text or symbol)	Blank
L6	Blue operator (no text or symbol)	Blank
L7	Clear operator (no text or symbol)	Blank
Selector Switches*->⊗+⊕		
Code	Description	Legend Plate Text (When Selected)
SH	2-position	Standard-maintained
KH		Keyed-maintained
SJ	3-position	Standard-maintained
KJ		Keyed-maintained

Note: Footnote explanations on previous page.

b...k, continued

Operator Type			
2- Function Multi-Operator Push Buttons*->⊗+⊕			
Code	Description	Legend Plate Text (When Selected)	
VV	Black/white operator with arrow (down & up)	Not provided	
VW	Black/white operator with arrow (left & right)		
VX	Black/white operator with arrow (reverse & forward)		
WV	Black/white operator, illuminated, with arrow (down & up)		
WW	Black/white operator, illuminated, with arrow (left & right)		
WX	Black/white operator, illuminated, with arrow (reverse & forward)		
XV	Black/white operator with double arrows (down fast & up fast)		
XW	Black/white operator with double arrows (left fast & right fast)		
XX	Black/white operator with double arrows (reverse fast & forward fast)		
YV	Black/white operator, illuminated, with double arrows (down fast & up fast)		
YW	Black/white operator, illuminated, with double arrows (left fast & right fast)		
YX	Black/white operator, illuminated, with double arrows (reverse fast & forward fast)		
Pilot Lights*->⊗+⊕			
Code	Description		Legend Plate Text (When Selected)
P0	Amber LED	Blank	
P3	Green LED	Blank	
P4	Red LED	Blank	
P5	Yellow LED	Blank	
P6	Blue LED	Blank	
P7	Clear LED	Blank	
Potentiometers*->⊗+⊕			
Code	Description	Legend Plate Text (When Selected)	
1P	Black operator — 150 Ω	Blank	
2P	Black operator — 500 Ω	Blank	
3P	Black operator — 1000 Ω	Blank	
4P	Black operator — 2500 Ω	Blank	
5P	Black operator — 5000 Ω	Blank	
6P	Black operator — 10 000 Ω	Blank	
Hole Plug*->⊗+⊕			
Code	Description	Legend Plate Text (When Selected)	
N2	Black hole plug	Blank	

b_{1...k}1

Interlock and/or Rubber Boot	
Code	Description
N	No interlock, no additional boots
E	Electrical interlock, no additional boots
M	Mechanical interlock, boots standard‡
B	Electrical and mechanical interlock, boots standard‡
R	No interlock, additional rubber boot
S	Electrical interlock, additional rubber boot

Accessories
 Engraved Legend Plates

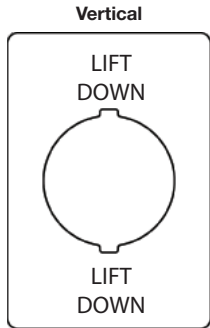

Cat. No. 800F-36VE416

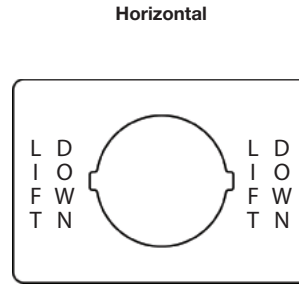

Cat. No. 800F-36HE416

Description	Cat. No.	Description	Cat. No.
Blank	800F-36BE100	1-2-3 SPEED, O/H CRANE, FORWARD	800F-36SE411
O-I	800F-36SU231	1-2-3 SPEED, O/H CRANE, REVERSE	800F-36SE412
I-O-II	800F-36SU234	ALARM	800F-36SE413
RESET	800F-36SE186	HOIST, LEFT	800F-36SE414
START	800F-36SE208	HOIST, RIGHT	800F-36SE415
STOP	800F-36SE212	LIFT, DOWN	800F-36SE416
1-2 SPEED, HOIST, LEFT	800F-36SE401	LIFT, DOWN FAST	800F-36SE417
1-2 SPEED, HOIST, RIGHT	800F-36SE402	LIFT, UP	800F-36SE418
1-2 SPEED, LIFT, DOWN	800F-36SE403	LIFT, UP FAST	800F-36SE419
1-2 SPEED, LIFT, UP	800F-36SE404	O/H CRANE, FORWARD	800F-36SE420
1-2 SPEED, O/H CRANE, FORWARD	800F-36SE405	O/H CRANE, FORWARD, FAST	800F-36SE421
1-2 SPEED, O/H CRANE, REVERSE	800F-36SE406	O/H CRANE, LEFT FAST	800F-36SE422
1-2-3 SPEED, HOIST, LEFT	800F-36SE407	O/H CRANE, REVERSE	800F-36SE423
1-2-3 SPEED, HOIST, RIGHT	800F-36SE408	O/H CRANE, REVERSE, FAST	800F-36SE424
1-2-3 SPEED, LIFT, DOWN	800F-36SE409	O/H CRANE, RIGHT FAST	800F-36SE425
1-2-3 SPEED, LIFT, UP	800F-36SE410	START, ALARM	800F-36SE426
		Custom text	800F-36SE100*

§ For vertically mounted operators, add a **V** to the cat. no. Example: **Cat. No. 800F-36SE186** becomes **Cat. No. 800F-36VE186**.
 For horizontally mounted operators, add an **H** to the cat. no. Example: **Cat. No. 800F-36SE186** becomes **Cat. No. 800F-36HE186**.

* Font code (**K**, **S**, **L**) must be selected from the following table.

* Please fill in the custom text fax sheet found on page 112 to ensure accuracy of legend plate engraving.

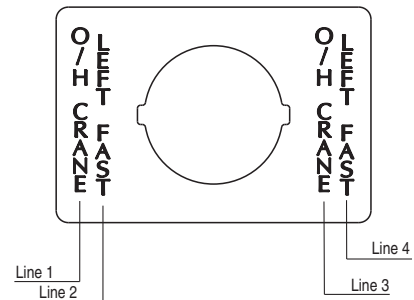
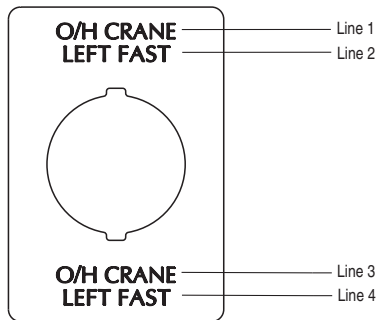

Font Size	Vertical Mounting (V)		Horizontal Mounting (H)	
	Max. Characters Per Line	Max. No. of Lines	Max. Characters Per Line	Max. No. of Lines
K (small)	16	4	9	4
S (standard)	14	4	8	4
L (large)	10	2	7	2

	Description	Pkg. Quantity	Cat. No.
	Plastic mounting latch	10	800F-ALP
	Mechanical interlock latch	1	* 800FC-ALP
	Replacement wire guide †	10	800FC-AWG
	Replacement trim washer	10	800F-ATW1
	Insulated side jumper	50	1492-SJ5A-24
			1492-SJ5A-10
	Hole plug	1	800F-N2
	Contact block	10	Description
			Type
			N.O.
			N.C.
			N.O. low voltage — QuadCONNECT™
			N.C. low voltage — QuadCONNECT™
			N.C.E.B.
			NOEM* ‡
NOEM ‡			
NOEEM †			
	Cable sleeve	1	3-hole (M20 x 1.5)
			5-...9-hole (M32 x 1.5)
	Protective boot	10	Extended push button
			2-position multi-operator
	Narrow plastic guard	1	Yellow
			800F-AMEGY
	Integrated LED module	10	24V AC/DC
			120V AC
			§ 800F-N3x
			§ 800F-N5x

- * Only for use with 1-, 2-, and 3-speed operators.
- * First contact closure of 1- and 2-speed operators.
- ‡ Second contact closure of 2-speed operators and third contact closure of 3-speed operators.
- † First contact closure of 3-speed operators.
- ‡ For proper operation, **Cat. No. 800F-X10M** must be mounted in position 3 of the mechanical or standard latch.
- § Not for use with 1-, 2-, and 3-speed operators.
- § To complete the cat. no., replace the x with one of the following letters for the desired color: **Y** = Amber, **R** = Red, **G** = Green, **B** = Blue, **W** = White.
- † Wire guides are provided with enclosures.

Bulletin 800FC

22.5 mm Configured Pendant Stations

Specifications

Specifications*

Front-of-Panel (Operators)

Mechanical Ratings		
Description	Plastic (Bulletin 800FP)	
Vibration (assembled to panel)	Tested at 10...2000 Hz, 1.52 mm displacement (peak-to-peak) max./10 G max. for 3 hr duration, no damage	
Shock	Tested at 1/2 cycle sine wave for 11 ms; no damage at 100 G	
Degree of protection*	IP66 (Type 4/4X/13)	
Mechanical durability per EN 60947-5-1 (Annex C)	10 000 000 Cycles	Momentary push buttons
	1 000 000 Cycles	Multi-function, selector switch, key selector switch
	300 000 Cycles	Twist-to-release E-stop, illuminated push-pull E-stop, alternate action push buttons
	100 000 Cycles	Potentiometer, toggle switch
Operating forces (typical with one contact block)	Flush/extended = 5 N, E-stop = 36 N	
Operating torque (typical application with one contact block)	Selector switch = 0.25 N•m (2.2 lb•in)	
Mounting torque	1.7 N•m (15 lb•in)	
Environmental		
Temperature range (operating)	-25...+70 °C (-13...+158 °F)‡	
Temperature range (short term storage)	-40...+85 °C (-40...+185 °F)	
Humidity	50...95% RH from 25...60 °C (77...140 °F)	

* Performance Data — see page Important-3 of the Industrial Controls catalog.

‡ Plastic keyed operators are IP66, Type 4/13; not Type 4X.

‡ Operating temperatures below 0 °C (32 °F) are based on the absence of freezing moisture and liquids, UL Recognized to 55 °C (131 °F) - Incandescent module max. 40 °C (104 °F) - fully populated 9-hole pendant enclosure 45 °C (113 °F) with 75 °C wire.

Note: Use UL Listed type S or SJ cords, with a smooth outer jacket rated for wet locations use (marked W) and oil resistant outer covering (marked O) such as SOW or SJOW with copper wire, rated 75 °C min., 18...12 AWG, with an overall OD of 7.5...15 mm for the small cable sleeve (**Cat. No. 800FC-AS3**) and 9...22.5 mm for the large cable sleeve (**Cat. No. 800FC-AS5**).

Material Listing

Component	For Use with	Material Used
Panel gasket	All operators	Nitrile, TPE
Diaphragm seal	Illuminated push button, non-illuminated push button	Automotive industry acceptable silicone
K-seal	Selector switch, key selector switch, push/twist-to-release E-stop, key E-stop	Nitrile
Diaphragm retainer, return spring I	Illuminated push button, non-illuminated push button	Stainless steel
Return spring II	Selector switch, key selector switch, alternate action, push/twist-to-release E-stop, key E-stop	Zinc-coated music wire
Button cap	Non-illuminated push button, push/twist-to-release, E-stop, key E-stop, multi-function	PBT/polycarbonate blend
2-color molded button cap	Non-illuminated push button	PBT/polycarbonate blend
Lens	Multi-function	Acetal
Lens, knob	Illuminated push button	Polyamide
Knob	Non-illuminated selector switch	Glass-filled polyamide
Plastic bezel/bushing I	Non-illuminated push button, illuminated push button, selector switch, key selector switch, push/twist-to-release E-stop, key E-stop, multi-function	Glass-filled polyamide
Plastic bezel/bushing II	Pilot light	Glass-filled PBT
Diffuser	Illuminated push button, pilot light	Polycarbonate
Plastic mounting ring	All plastic operators	Glass-filled polyamide
Plastic latch	—	Glass-filled polyamide
Mechanical interlock latch	—	Glass-filled polyamide
Plastic enclosure	—	PBT/polycarbonate blend
Terminal screws	LED module, contact blocks	Zinc-plated steel with chromate
Terminals	LED module, contact blocks	Brass with silver-nickel contacts
Housing	LED module	Glass-filled polyamide
Low-voltage terminals	Contact blocks	Gold-plated silver-nickel contacts
Low-voltage spanner	Contact blocks	Gold-plated silver-nickel contacts
Spanner	Contact blocks	Brass with silver-nickel contacts
Boot	Illuminated push button, non-illuminated push button, multi-function illuminated and non-illuminated	Automotive industry acceptable silicone

22.5 mm Configured Pendant Stations

Specifications

Back-of-Panel Components*

Electrical Ratings			
Standard contact block ratings		A600, Q600 600V AC AC 15, DC 13 to IEC/EN 60947-5-1 and UL 508, 17V, 5 mA min.	
Low voltage contact block ratings*		5V, 1 mA DC min. C300, R150, AC 15, DC 13 to EN 60947-5-1 and UL 508	
	Nominal Voltage	Range	Current Draw
LED Module Ratings	24V AC 24V DC 120V AC 240V AC	10...29V AC 10...30V DC 70...132V AC 180...264V AC	31 mA 24 mA 25 mA 22 mA
Thermal current		10 A max. enclosed (40 °C ambient) to UL508, EN 60947-5-1	
Insulation voltage (U _i)		Screw terminal = 690V, spring-clamp = 300V	
Wire capacity (screw terminal)‡		#18...12 AWG (0.75...2.5 mm ²) Max. (2) #14 AWG or (1) #12 AWG	
Wire capacity (spring-clamp terminal)		#18...14 AWG (0.75...1.5 mm ²) One per spring clamp, two spring clamps per terminal	
Recommended tightening torque on screw terminals		0.7...0.9 N•m (6...8 lb•in)	
Dielectric strength (minimum)		2500V for one minute	
External short circuit protection	Standard blocks	10 A type gL/gG cartridge fuse to EN 60269-2-1 or gN (Class J to UL 248-8 or Class C to UL 248-4)	
	Low voltage contact blocks	6 A type gL/gG cartridge fuse to EN 60269-2-1 or gN (Class J to UL 248-8 or Class C to UL 248-4)	
Electrical shock protection		Finger-safe conforming to IP2X	
Mechanical Ratings			
Vibration (assembled to panel)		Tested at 10...2000 Hz, 1.52 mm displacement (peak-to-peak) max./10 G max. 6 hr	
Shock		Tested at 1/2 cycle sine wave for 11 ms and no damage at 100 G max.	
Contact durability per EN 60947-5-1 (Annex C)		10 000 000 cycles	
Contact operation	N.O.	Slow double make and break	
	N.C.	Slow double make and break — positive opening ⊖	
	N.O.E.M.	Double break / double make, early make	
	N.C.L.B.	Double break / double make, late break — positive opening ⊖	
	N.C.E.B.	Double break / double make, early break — positive opening ⊖	
	N.O.E.E.M.	Double break / double make, early early make	
	N.O.L.M.	Double break / double make, late make	
Standard push button travel to change electrical state	N.C. and N.O.E.M.	1.5 mm (0.060 in.)	
	N.O. and N.C.L.B.	2.5 mm (0.1 in.)	
Multi-speed push button travel to change electrical state	N.O.E.E.M.	3 mm (0.12 in.)	
	N.C.E.B.	4 mm (0.16 in.)	
Operating forces (typical)	Single-circuit contact block	3.4 N	
	Dual-circuit contact block	5...6.5 N	
Illumination			
LED Dominant Wavelength	Green	525 nm	
	Red	629 nm	
	Yellow	590 nm	
	Blue	470 nm	
	White	—	
LED Luminous Intensity	Green	780 mcd	
	Red	780 mcd	
	Yellow	600 mcd	
	Blue	168 mcd	
	White	360 mcd	
Materials			
Springs		Stainless steel and zinc coated music wire	
Electrical contacts	Standard	Silver-nickel	
	Low voltage	Gold-plated over silver	
Terminals	Screw	Brass	
	Spring-clamp	Silver-plated brass	

* Performance Data — see page Important-3 of the Industrial Controls catalog.

* Low voltage contacts are recommended for applications below 17V, 5 mA.

‡ Wires less than #18 AWG (0.75 mm²) may not hold in terminal securely.



Allen-Bradley

www.ab.com/catalogs Preferred availability cat. nos. are **bold**.

Publication A117-CA001B-EN-P

10-137

22.5 mm Configured Pendant Stations

Approximate Dimensions

Approximate Dimensions *

Bul. 800FC 1-, 2-, and 3-Speed Operator

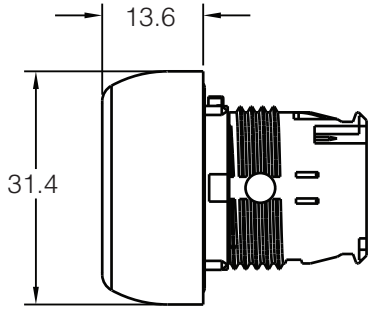

Bul. 800FC Legend Plate

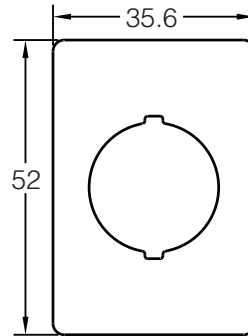

Bul. 800FC Pendant Station (3-Hole)

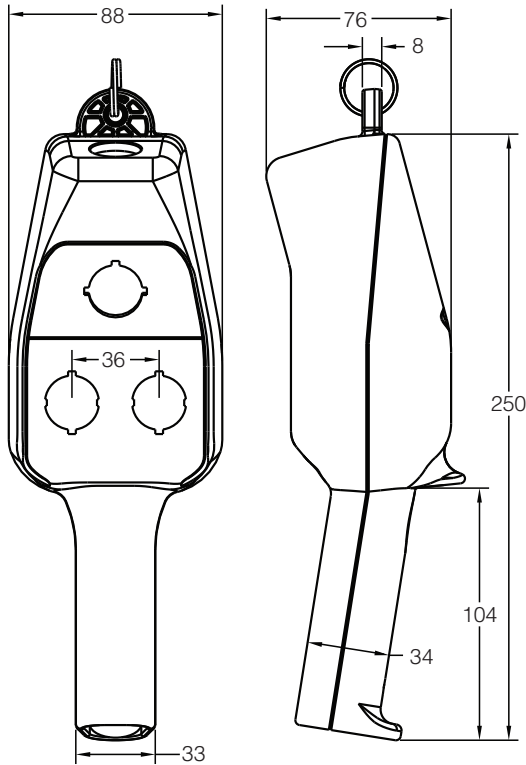

Bul. 800FC Pendant Station (5-, 7-, and 9-Hole)

Cat. No.	No. of Holes	A	B
800FC-4/5/C/D	5	309	36
800FC-6/7/E/F	7	381	36
800FC-8/9/G/H	9	453	36

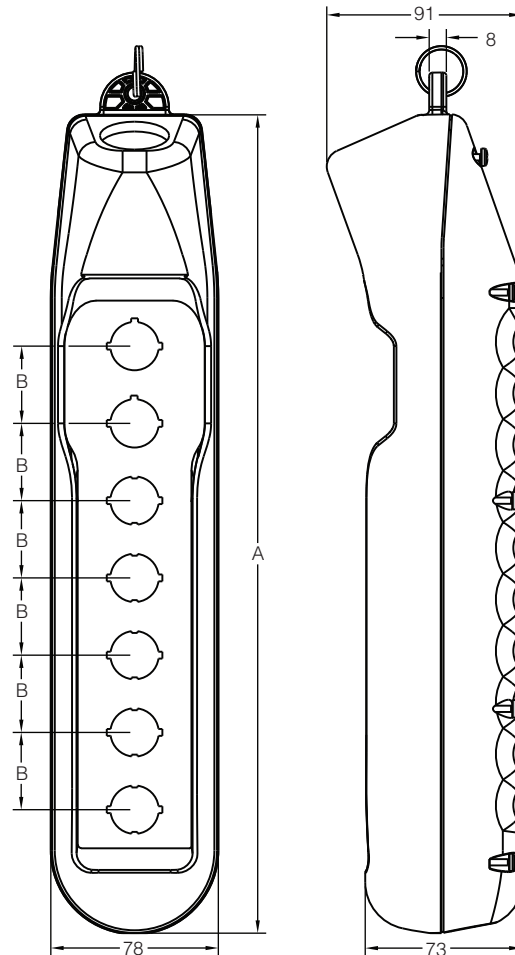

* For Bul. 800F operator dimensions, see page 10-120.

Custom Text Fax/Scan Sheet

Order/Item _____

Vertical Mounting

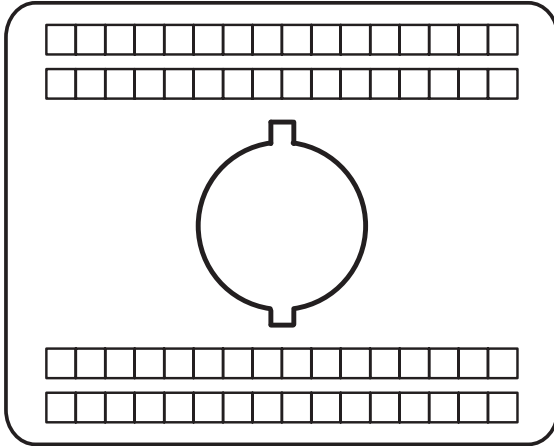

Cat. No. 800F-36VE100K

Horizontal Mounting

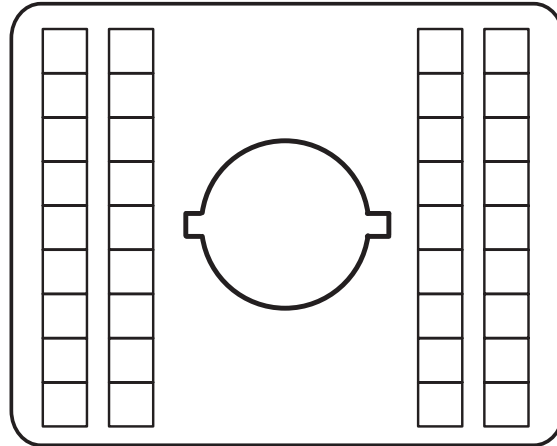

Cat. No. 800F-36HE100K

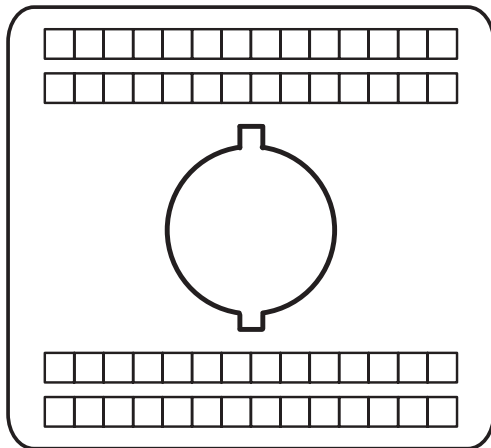

Cat. No. 800F-36VE100S

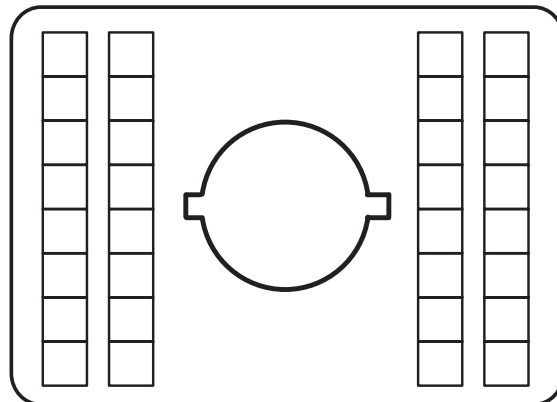

Cat. No. 800F-36HE100S

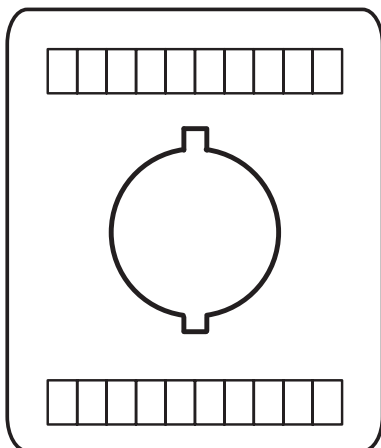

Cat. No. 800F-36VE100L

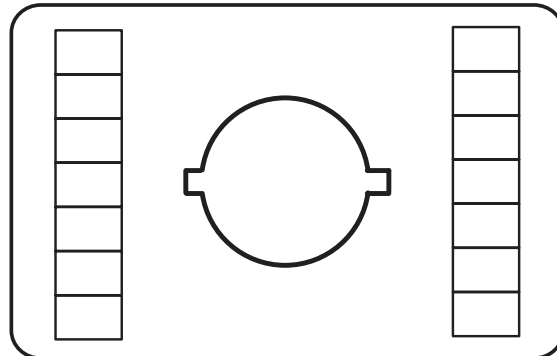

Cat. No. 800F-36HE100L

22.5 mm Monolithic Push Buttons

Product Overview/Selection



Bulletin 800FD Monolithic Push Buttons

With a single catalog number, you can now order a fully assembled product for easy stocking and installation. Designed to meet worldwide standards, the Bul. 800FD monolithic line includes E-stops and pilot lights with either LED or incandescent options.

- Ease of installation
- Low back-of-panel profile (45.7 mm)
- Aesthetic design complements the Bul. 800F modular line
- Anti-rotation tab provides accurate alignment and can be easily removed for use in panels without notches
- Lowest cost of installation
- Made of industrial-grade thermoplastic for superior chemical resistance
- Designed to meet worldwide standards
- Compatible with Bul. 800F accessories and enclosures
- Ring lug capability

Table of Contents

Push Buttons..... this page
 Pilot Lights 10-141
 Selector Switches..... 10-142
 Mushroom/E-Stops... 10-142
 Accessories..... 10-143
 Specifications..... 10-144
 Approximate Dimensions..... 10-145

Product Selection

Momentary Push Button Operators, Non-Illuminated



Operator Type	Cap Color	Pkg. Quantity	Contact Configuration		
			1 N.O. Cat. No.	1 N.C. Cat. No.	1 N.O. & 1 N.C. Cat. No.
Flush	Black	1	800FD-F2X10	800FD-F2X01	800FD-F2X11
	Green		800FD-F3X10	800FD-F3X01	800FD-F3X11
	Red		800FD-F4X10	800FD-F4X01	800FD-F4X11

800FD – **F** **3** **01** **X** **11**
a *b* *c* *d* *e*

a

Operator Type	
Code	Description
F	Flush
E	Extended

b

Color Cap	
Code	Color
1	White
2	Black
3	Green
4	Red
5	Yellow
6	Blue

c

Legend Text**	
Code	Text
—	No text (blank)
01	START
02	STOP
05	O
06	I
08	→
09	FORWARD
10	REVERSE
11	R

* White and yellow caps have black text. All other color caps have white text.
 ** Valid color cap/legend text combinations are as follows:

d

Termination Style	
Code	Description
X	Standard screw
R	Ring lug

e

Contact Module		
Code	Number of N.O.	Number of N.C.
01	0	1
10	1	0
11	1	1
02	0	2
20	2	0

Color	Text	
	Flush Caps	Extended Caps
White	START, I, →, FORWARD, REVERSE, R	→, R
Black	→, FORWARD, REVERSE, R	STOP, O, →, R ‡
Green	START, I, →, FORWARD, REVERSE	→
Red	→, FORWARD, REVERSE	STOP, O, → ‡
Yellow	→, FORWARD, REVERSE	→
Blue	→, FORWARD, REVERSE, R	→, R

‡ "STOP" or "O" color cap/legend text are not available for "10" or "20" contact modules.



Pilot Light Devices — LED



Lens & LED Color	Pkg. Quantity	Voltage		
		24V AC/DC Cat. No.	120V AC Cat. No.	240V AC Cat. No.
Green	1	800FD-P3N3	800FD-P3N5	800FD-P3N7
Red		800FD-P4N3	800FD-P4N5	800FD-P4N7
Yellow		800FD-P5N3	800FD-P5N5	800FD-P5N7

800FD - P 3 N 7
 a b c

a

Lens Cap	
Code	Color
0	Amber
3	Green
4	Red
5	Yellow
6	Blue
7	Clear

b

Voltage	
Code	Type
3	24V AC/DC
5	120V AC
7	240V AC

c

Termination Style	
Code	Description
Blank	Standard screw
R	Ring lug

Pilot Light Devices — Incandescent

Lens & LED Color	Pkg. Quantity	Voltage	
		24V AC/DC Cat. No.	120V AC Cat. No.
Green	1	800FD-P3D3	800FD-P3D5
Red		800FD-P4D3	800FD-P4D5
Yellow		800FD-P5D3	800FD-P5D5

800FD - P 3 D 5
 a b c

a

Lens Cap	
Code	Color
0	Amber
3	Green
4	Red
5	Yellow
6	Blue
7	Clear
9	No lens*

b

Voltage	
Code	Type
0	No Bulb*
1	6V AC/DC
2	12V AC/DC
3	24V AC/DC
4	48V AC/DC
5	120V AC/DC

c

Termination Style	
Code	Description
Blank	Standard screw
R	Ring lug

* Only valid with "no bulb" option.
 * Only valid with "no lens" option.

22.5 mm Monolithic Push Buttons

Product Selection/Accessories

Plastic Enclosures — 1-Hole Only

- Feed-through design
- Knockout sizes: PG 11/16
- Not UL Listed or CSA Certified
- Monolithic or latch-mounted contact blocks
- Double insulated



Type	Pkg. Quantity	Plastic Enclosures (IP66, NEMA 4/4X/13)*	
		Grey	Yellow
		Cat. No.	Cat. No.
1-hole	1	800FD-1P	800FD-1PY

* Can only use single deep contact block.

Assembled Stations

Enclosure Color	Quick Connect	Operator Type	Contact Configuration	Cat. No.
Grey	N/A	2-position selector switch	1 N.O.	800FD-1SP5
			1 N.O./1 N.C.	800FD-1SP6
	DC Micro 4-pin		800FD-1SP6Q	
Yellow	N/A	Red 40 mm push-pull/twist-to-release	1 N.O./1 N.C.	800FD-1SYP2
	DC Micro 4-pin			800FD-1SYP2Q

Accessories

Replacement Lamps

Lamp	Type	Typical Current	Voltage	ANSI No.	Pkg. Quantity	Cat. No.
 Cat. No. 800F-N130	Full Voltage Incandescent	150 mA	6V AC/DC	755	10‡	800F-N65
		80 mA	12V AC/DC	756		800F-N141
		70 mA	24V AC/DC	757		800F-N157
		50 mA	48V AC/DC	1835		800F-N48
		22 mA	130V AC/DC	949		800F-N130
 Cat. No. 800F-N240	Neon	2 mA	240V AC	—		800F-N240

Replacement Lenses

Lens Color	Pkg. Quantity	Cat. No.
Amber	10‡	800FD-AP0
Green		800FD-AP3
Red		800FD-AP4
Yellow		800FD-AP5
Blue		800FD-AP6
Clear		800FD-AP7

‡ Sold in multiples of 10. Order (quantity of) 10 to receive one package of 10 pieces.

Bulletin 800FD
22.5 mm Monolithic Push Buttons
 Specifications

Specifications*

Mechanical Ratings				
Vibration (assembled to panel)	Tested at 10...2000 Hz, 1.52 mm displacement (peak-to-peak) max./10 G max. for 3 hr duration, no damage			
Shock	Tested at 1/2 cycle sine wave for 11 ms; no damage at 100 G			
Degree of protection	IP66 (Type 3/3R/4/4X/12/13)			
Mechanical durability per EN 60947-5-1 (Annex C)	300 000 cycles	Selector switch		
	2 000 000 cycles	Push-pull/twist-to-release E-stop		
Operating forces	Momentary push buttons			
Operating torque (typical application with one contact block)	E-stop = 36 N			
	N.O.	Selector switch = 0.25 N•m		
Contact operation	Slow double make and break			
	N.C.	Slow double make and break - positive opening		
Push button travel to change electrical state	N.O.	2.5 mm (0.1 in.)		
	N.C.	1.5 mm (0.060 in.)		
Environmental				
Temperature range (operating)	-25...+60 °C (-13...+140 °F)*			
Temperature range (short term storage)	-40...+85 °C (-40...+185 °F)			
Humidity	50...95% RH from 25...60 °C (77...140 °F)			
Electrical Ratings				
Standard contact block ratings	B300, R300 AC 15, DC 13 300 VAC EN/IEC 60947-5-1 and UL 508, 17V, 5 mA min.			
	Nominal Voltage	Range	Current Draw	Frequency
LED module ratings	24V AC	20...26V AC	32 mA	50/60 Hz
	24V DC	18...30V DC	24 mA	DC
	120V AC	102...132V AC	22 mA	50/60 Hz
	240V AC	204...264V AC	22 mA	50/60 Hz
Thermal current	5 A max. enclosed (40 °C ambient) to UL 508, EN/IEC 60947-5-1			
Insulation voltage (U _i)	300V			
Wire capacity (screw terminal)	#18...14 AWG (0.75...2.5 mm ²) Max. (2) #14 AWG, uses same size wire only			
Recommendations for ring lug termination option‡	6.35 mm (0.250 in.) Max. outer diameter with 3.8 mm (0.148 in.) hole diameter			
Recommended tightening torque on screw terminals	0.7...0.9 N•m (6...8 lb•in)			
Dielectric strength (minimum)	2500V for one minute			
External short circuit protection	5 A Type gL/gG cartridge fuse to EN 60269-2-1 or gN (Class J to UL 248-8 or Class CC to UL 248-4)			
Electrical shock protection	Finger-safe conforming to IP2X			
Illumination				
LED dominant wavelength	Green	525 nm		
	Red	629 nm		
	Yellow	590 nm		
	Blue	470 nm		
	White	—		
LED luminous intensity	Green	780 mcd		
	Red	780 mcd		
	Yellow	600 mcd		
	Blue	168 mcd		
	White	360 mcd		
Incandescent maximum wattage	2.6 W			

* Performance Data — see page Important-3 of the Industrial Controls catalog.

* Operating temperatures below 0 °C (32 °F) are based on the absence of freezing moisture and liquids.

‡ 3M MV018-R/S (#22...18 AWG) or 3M MVU14-6R/S (#16...14 AWG)

22.5 mm Monolithic Push Buttons

Specifications, Approximate Dimensions, and Instruction Sheet Information

Specifications, Continued*

Materials			
Springs	Stainless steel and zinc coated music wire	Lens (pilot light)	Acrylic
Electrical contacts	Brass with silver-nickel contacts	Bezel/bushing, housing	Glass-filled polyester
Terminals	Brass and phosphor bronze	Legend frames	Glass-filled polyamide
Panel gasket	Nitrile and polyester-based TPE	Mounting ring	Glass-filled polyamide
Seal	Nitrile	Terminal screws	Zinc-plated steel with chromate
Button cap/mushroom head	Polyester/polycarbonate blend	Lamp socket	Brass and Phosphor bronze

* Performance Data — see page Important-3 of the Industrial Controls catalog.

Product Certifications

Certifications	UL, CSA, CCC, CE
Conformity to standards — CE Marked	UL 508, EN/ISO 13850, EN 60947-1, EN 60947-5-1, EN 60947-5-5
Terminal identification	EN/IEC 60947-1

Approximate Dimensions

Dimensions in millimeters. Dimensions are not intended to be used for manufacturing purposes. Refer to RAISE software for additional dimensional information.

Momentary Push Button Operators — Flush

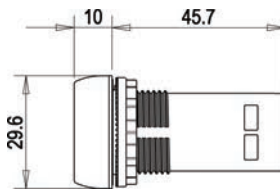

Momentary Push Button Operators — Extended

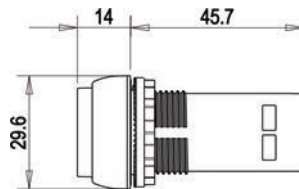

Pilot Light Devices

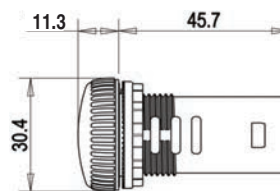

2-Position Push-Pull/Twist-to-Release Mushroom Operators

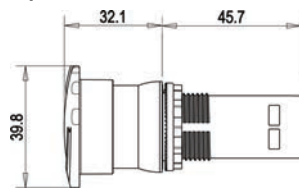

Selector Switch Operators

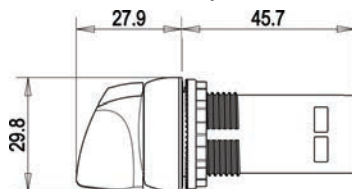

Plastic Enclosures

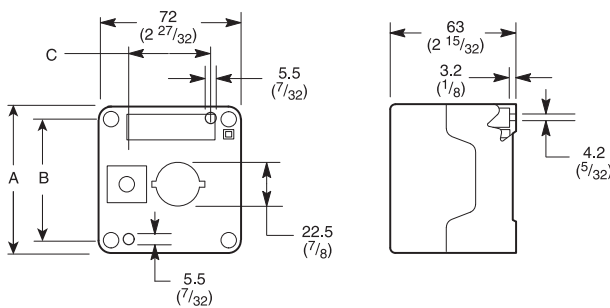

Instruction Sheet

Option	Terminal 1	Terminal 2	Terminal 3	Terminal 4	Terminal 5	Terminal 6
A	○	○				
B	○ +					
	○	○	○	○	○	EMERGENCY STOP
	30	40	50	40	50	ø60, ø90
	30		40			60/90

Plastic Enclosures					
Cat. No.	No. of Units (Holes)	A	B	C	Weight
800FD-1P	1	72	59	41	95 g
800FD-1PY		(2-27/32)	(2-5/16)	(1-5/8)	(3.5 oz)

16 mm Push Buttons

Product Overview/Specifications



Bulletin 800B — 16 mm Push Buttons

- Designed to worldwide standards (UL, CSA, CE, and CCC)
- Durable materials
 - Operators are made of corrosion-proof plastic to ensure long push button life
 - Consistent coloring and illumination make these easy to identify for the life of the operator
- Ease of installation
- Ergonomic design
 - Contoured button surface
- Dependable sealing
 - IP66 and Type 4/13
 - Diaphragm seals: linear travel devices, pilot lights
 - V-seals: selector switches, high pressure sealing
 - K-seals: emergency stops, dual wiping action
- Reliable low voltage switching
 - Gold-plated snap action contacts
 - Reliable operation in applications below 24V DC, 5 mA down to 5V DC, 1 mA
- Enhanced E-stop functionality
 - Anti-tease feature standard (trigger-action)
 - EN13850 and EN 60947-5-5 compliant
 - Direct Drive mechanism (positive actuation)

Table of Contents

Product Selection this page
 Accessories..... 10-149
 Specifications..... 10-150
 Approximate Dimensions..... 10-151

Standards Compliance and Certifications

Certifications	UR, CSA, CCC, CE
Standards Compliance	UL 508, EN ISO 13850, EN 60947-1, EN 60947-5-1, EN 60947-5-5
Terminal Identification	EN/IEC 60947-1
RoHS Compliant	✓

Push Button & Pilot Light Operators*

Operator Type	Cat. No.			
	○	□	▭	▣
	Round	Square	Rectangle	Large Square
Momentary, push button/pilot light	800B-EPA	800B-EPB	800B-EPC	800B-EPD
Maintained, push button	800B-EAA	800B-EAB	800B-EAC	800B-EAD

Note: Package Quantity = 1

* All operators are sold without a lens cap and diffuser.

Lens Cap with Diffuser§



Cat. No. 800B-ALA3



Cat. No. 800B-ALB4



Cat. No. 800B-ALC5



Cat. No. 800B-ALD6









Lens Color	Cat. No.			
	Round	Square	Rectangle	Large Square
Green	800B-ALA3	800B-ALB3	800B-ALC3	800B-ALD3
Red	800B-ALA4	800B-ALB4	800B-ALC4	800B-ALD4
Yellow	800B-ALA5	800B-ALB5	800B-ALC5	800B-ALD5
Blue	800B-ALA6	800B-ALB6	800B-ALC6	800B-ALD6
White	800B-ALA7	800B-ALB7	800B-ALC7	800B-ALD7

Note: Package Quantity = 1

§ For illuminated devices, LED bulbs are color specific. (Green LED bulb with green lens caps, red LED bulbs with red lens cap, white LED bulbs used with yellow, blue, and white lens cap.) Incandescent bulbs can be used with any lens cap color.







Selector Switch Operators*

Operator Type	2-Position Selector Switches		3-Position Selector Switches	
				
	Maintained	Return from Right	Maintained	Return from Both
Cat. No.	800B-SM2A	800B-SR2A	800B-SM3A	800B-SB3A
Operator Type				
	Keyed, Maintained	Keyed, Return from Right	Keyed, Maintained	Keyed, Return from Both
Cat. No.	800B-KM2A	800B-KR2A	800B-KM3A	800B-KB3A

Note: Package Quantity = 1

Target Table and Operator Position

Contact Block Cat. No.	Contact Block Location	Contact Type	2-Position Target Table		3-Position Target Table		
							
800B-PS11	Top	NA	—	—	—	—	—
	Bottom	N.C.	X	O	O	X	X
		N.O.	O	X	X	O	O
800B-PS22	Top	N.C.	X	O	X	X	O
		N.O.	O	X	O	O	X
	Bottom	N.C.	X	O	O	X	X
		N.O.	O	X	X	O	O
800B-PT01	Top	NA	—	—	—	—	—
	Bottom	N.C.	X	O	O	X	X
800B-PT02	Top	N.C.	X	O	X	X	O
	Bottom		X	O	O	X	X
800B-PT11	Top	N.O.	O	X	O	O	X
	Bottom	N.C.	X	O	O	X	X

Note: X = Closed/O = Open

* To illuminate a selector switch, add either an LED or incandescent bulb. All selector switches have a clear lens. Green and red LED bulbs can be used to change the selector switch color.

Emergency Stop Operators — Non-Illuminated, Twist-to-Release (Trigger Action)‡

	Description	Pkg. Quantity	Cat. No.
 Cat. No. 800B-MT	Emergency stop operator	1	800B-MT

‡ Operator is EN ISO 13850 compliant with standard N.C. contact blocks.

Bulletin 800B
16 mm Push Buttons
 Product Selection

Contact Block/Latch Module

	Description	Pkg. Quantity	Cat. No.
Push Button/Selector Switch			
 <i>Cat. No. 800B-PS11</i>	1 N.O./1 N.C. snap action	1	800B-PS11
 <i>Cat. No. 800B-PS22</i>	2 N.O./2 N.C. snap action	1	800B-PS22
Pilot Light			
 <i>Cat. No. 800B-PL</i>	Dummy block	1	800B-PL
Emergency Stop/Push Button/Selector Switch			
 <i>Cat. No. 800B-PT01</i>	1 N.C. slow make/break	1	800B-PT01
 <i>Cat. No. 800B-PT02</i>	2 N.C. slow make/break	1	800B-PT02
 <i>Cat. No. 800B-PT11</i>	1 N.O./1 N.C. slow make/break	1	800B-PT11

Replacement Bulbs

10

	Description	Lamp Color	Lamp Voltage	Pkg. Quantity	Cat. No.
	LED bulb*	Green	12...24V AC/DC	1	800B-N3G
			120V AC		800B-N5G
		Red	12...24V AC/DC		800B-N3R
			120V AC		800B-N5R
		White	12...24V AC/DC		800B-N3W
			120V AC		800B-N5W
	Incandescent bulb*	Clear	6V AC/DC	800B-N1C	
			12V AC/DC	800B-N2C	
			24V AC/DC	800B-N3C	

* Not available in 6V AC/DC.

⊛ Not available in 120V AC.

Accessories

	Description	Pkg. Quantity	Cat. No.
 Cat. No. 800B-ARP	Replacement mounting ring	10	800B-ARP
 Cat. No. 800B-AW2	Mounting ring wrench	1	800B-AW2
 Cat. No. 800B-ALR1	Bulb removal tool	1	800B-ALR1
 Cat. No. 800B-ALR2	Lens removal tool	1	800B-ALR2
 Cat. No. 800B-ALW1	Locking washer (anti-rotation)	10	800B-ALW1
 Cat. No. 800B-ATK	Stab connector (insulated)	10	800B-ATK
 Cat. No. 800B-N2	Hole plug	10	800B-N2
 Cat. No. 800B-AK1	Replacement key	1	800B-AK1
 Cat. No. 800B-APCB	Printed circuit board pin socket	10	800B-APCB
 Cat. No. 800B-15YE112	Emergency stop legend plate	1	800B-15YE112
 Cat. No. 800B-ABZB	Square bezel	10	800B-ABZB
 Cat. No. 800B-ABZC	Rectangle bezel	10	800B-ABZC
 Cat. No. 800B-ABZD	Large square bezel	10	800B-ABZD

10

Bulletin 800B
16 mm Push Buttons
Specifications

Specifications

Mechanical Ratings		
Vibration (assembled to panel)	Tested at 10...2000 Hz, 1.52 mm displacement (peak-to-peak) max./10 G max. for 6 hr duration, no damage	
Shock	Tested at 1/2 cycle sine wave for 11 ms; no damage at 100 G	
Degree of protection*	IP66, Type 4/4X/13	
Mechanical durability per EN 60947-5-1 (Annex C)	2 000 000 Cycles	Push buttons – momentary
	1 000 000 Cycles	Push buttons – maintained
	250 000 Cycles	Selector switch
	200 000 Cycles	Key selector switch
	200 000 Cycles	Twist-to-release E-stop
Operating forces (typical with one contact block)	Extended = 5...8 N E-stop = 14...16 N	
Operating torque (typical application with one contact block)	Selector switch = 0.06 N•m (0.5 lb•in)	
Mounting torque	1.1 N•m (10 lb•in)	
Environmental		
Temperature range (operating)	-25...+55 °C (-13...+131 °F)	
Temperature range (short term storage)	-40...+70 °C (-40...+158 °F)	
Humidity	50...95% RH from 25...60 °C (77...140 °F)	

Mechanical Ratings — Contact Blocks		
Vibration (assembled to panel)	Tested at 10...2000 Hz, 1.52 mm displacement (peak-to-peak) max./10 G max. 6 hr	
Shock	Tested at 1/2 cycle sine wave for 11 ms and no damage at 100 G max.	
Contact durability	200 000 cycles (Cat. No. 800B-PS_)	
Contact operation	N.O. / N.C.	Snap action
	N.C.	Slow make/break positive opening
	N.O.	Slow make/break
Push button travel to change electrical state	1.4 mm (0.06 in.)	
Operating forces (typical)	1 contact block = 3 N 2 contact blocks = 6 N	

Electrical Ratings			
Standard contact block ratings	AC 15, B300, 1.5 A/240V AC, 3 A/120V AC DC 13, R300, 0.1 A/250V DC, 0.22 A/125V DC		
LED Module ratings	Nominal Voltage	Current	Frequency
	12...24V AC	12 mA	50/60 Hz
	12...24V DC	12 mA	DC
	120V AC	9 mA	50/60 Hz
Thermal current	$I_{th} = 5 \text{ A (AC)}, I_{th} = 1 \text{ A (DC)}$		
Insulation voltage (U_i)	300V		
Stab termination	2.8 X 0.5 mm		
Dielectric strength (minimum)	1500V 1 min.		
External short circuit protection – standard blocks	6 A type gL/gG cartridge fuse to EN 60269-2-1 or gN (Class J to UL 248-8 or Class C to UL 248-4)		
Electrical shock protection	Finger-safe conforming to IP2X		

Illumination		
LED Dominant wavelength	Green	525 nm
	Red	624 nm
	White	—
LED Luminous intensity	Green	500 mcd
	Red	400 mcd
	White	1000 mcd
Incandescent maximum wattage	1.2 W	

Materials	
Springs	Stainless steel and gold-plated, high-carbon steel
Electrical contacts	Gold-plated silver
Stab terminals	Phosphor bronze with gold or nickel plating
Lenses	Polycarbonate



Approximate Dimensions

Round

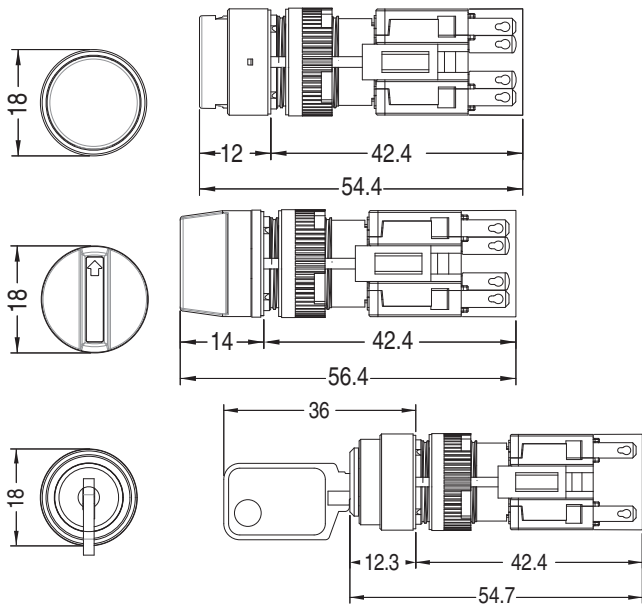

Hole Patterns

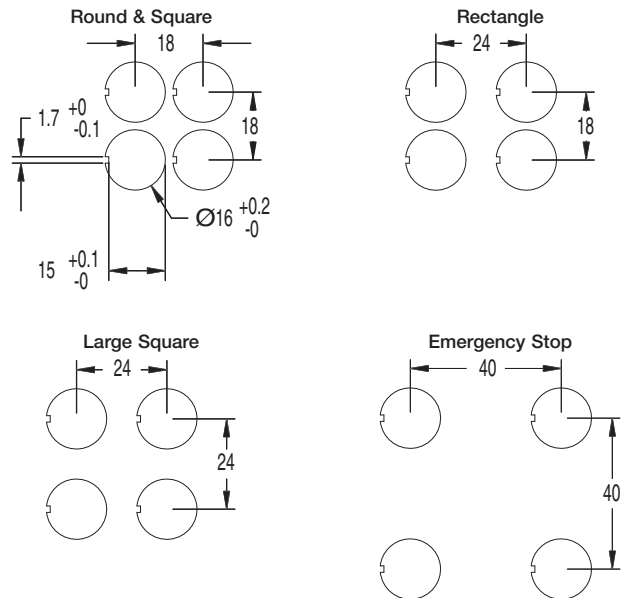

Square

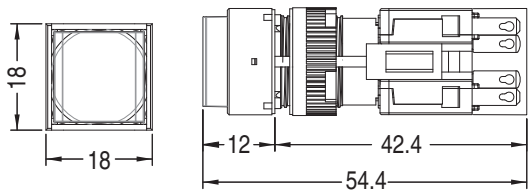

Printed Circuit Board Pin Socket

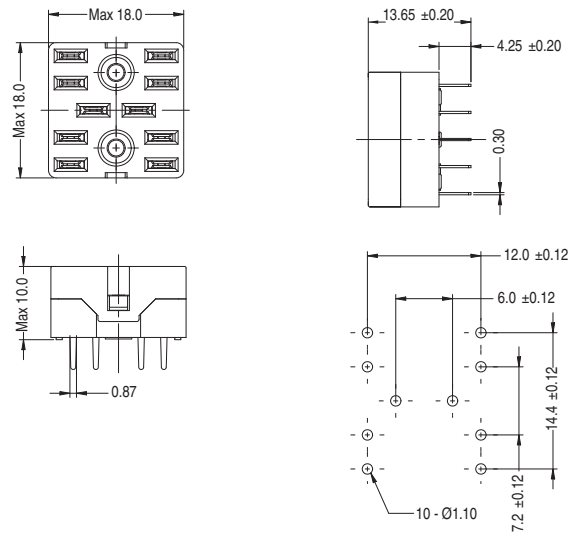

Rectangle

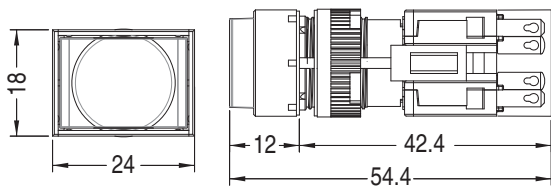

Large Square

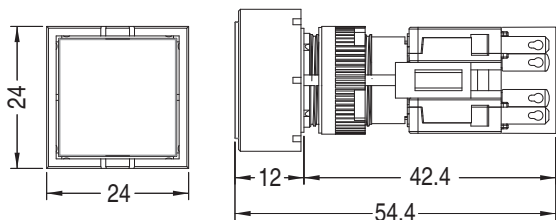

Emergency Stop

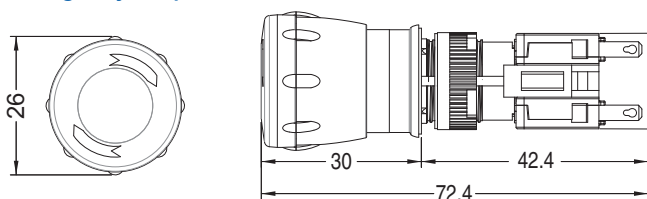

Hazardous Location Push Buttons

Product Overview/Specifications



Bulletin 800H/Hazardous Location Push Buttons

- Hazardous locations push buttons and stations
- Classes I, II & III Divisions 1 & 2
- 3/4 in. - 14 NPSM barrel
- Type 7 & 9
- Explosion-proof operators

Table of Contents

See below.

Standards Compliance
 UL698, UL1604
 CSA 22.2, No. 14

Certifications

Enclosures:
 UL Listed (File No. E71673
 Guide No. NNNY)

Devices:
 UL Listed (File No. E10314
 Guide No. NOIV)

Stations:
 CSA (File No. LR11924)

TABLE OF CONTENTS

Description	Page
Specifications	10-153
Complete Assembled Stations	10-154
Push Buttons, Momentary	
Non-Illuminated — Flush, Extended, Mushroom, Dual.....	10-155
Illuminated — Extended	10-157
Potentiometer	10-157
Push Buttons, Push-Pull	
Non-Illuminated — 2- and 3-Postition	10-159
Illuminated — 2- and 3-Postition	10-161
Selector Switches	
Non-Illuminated, 2-Position.....	10-163
Non-Illuminated, 3-Position.....	10-165
Non-Illuminated, 4-Position.....	10-167

Description	Page
Pilot Light Units	10-169
Ordering Information for Stations	10-171
Covers	10-172
Bases	10-173
Modifications and Accessories	
Contact Blocks.....	10-175
Knobs & Caps.....	10-176
Boots & Guards.....	10-177
Plugs & Locking Attachments.....	10-178
Miscellaneous.....	10-179
Replacement Lamps.....	10-180
Legend Plates.....	10-181
Approximate Dimensions	10-183

Description

Application

When properly mounted in a Type 7 & 9 enclosure, Bulletin 800H Type 7 & 9 operators are designed to meet the requirements of the National Electrical Code for Class I, Divisions 1 & 2, Groups B, C & D Hazardous Gas; Class II, Divisions 1 & 2, Groups E, F and G Hazardous Dust; and, Class III Hazardous Fiber Locations. In addition, the single gang shallow base, Cat. No. 800H-IHZX7, meets Class I, Group B requirements. This Type 7 & 9 equipment is listed by Underwriters Laboratories, Inc.

Per National Electrical Code:

Zone 1. In Class I, Zone 1 locations, all wiring methods permitted for Class I, Division 1 locations and Class I, Zone 0 or Zone 1 locations, including requirements for sealing, shall be permitted.

Zone 2. In Class I, Zone 2 locations, all wiring methods permitted for Class I, Division 2, Class I, Division 1 or Division 2, and Class I, Zone 0 or Zone 1 locations, including requirements for sealing, shall be permitted.

Operator Construction

The Allen-Bradley line of hazardous location devices features copper-free (less than 0.4 of 1% copper content) die cast aluminum bushings and mounting rings, Type #316 stainless steel operating shafts and an O-ring seal for added corrosion resistance. These components mount into a threaded hole (3/4 in.-14 NPSM) in a suitable enclosure.

Bulletin 800H Type 7 & 9 components are available in two basic formats: standard barrel (Bulletin 800H) and long barrel (Bulletin 800HL). Standard barrel devices are suitable for mounting in panel thickness up to 1 in.; Long barrel devices are suitable for mounting in panel thickness greater than 1 in. and no thicker than 2-1/2 in. Both style operators offer a unique locking bracket which provides an anti-turn feature to guard against loosening. The mounting rings in front of the panel are knurled to provide a second means of tightening each unit into the panel.

Outdoor Use

Bulletin 800H Type 7 & 9 stations and enclosures are not configured for outdoor use as standard. A Type 3 rating is available, while maintaining Type 7 & 9 integrity of the enclosure, by the addition of a Type 3 sealing flange and an approved drain. The sealing flange shown below may be purchased as an option or as an accessory. A Type 4 rating can be achieved by using sealing nuts to seal the push button operators in addition to using the sealing flange. Sealing nuts are available as accessories (see page 10-179.)

Elimination of Conduit Seal Off Requirement

Bulletin 800H Type 7 & 9 units may be installed with a variety of sealing options. By utilizing either a sealing well or flanged sealing well, these stations may be installed without a conduit seal off in most applications (subject to applicable codes and laws). The sealing wells shown below may be purchased as an option or as an accessory. Sealing wells are also available with an integral Type 3 flange seal for outdoor applications.

Sealed switch contact blocks are another way to eliminate the need for conduit seal fittings in most applications (subject to applicable codes and laws). Sealed switch contact blocks may be purchased as an option on assembled stations by changing the Bulletin No. from 800H to 800R. Sealed switch contact blocks can be ordered as an accessory (see page 10-175). A push button station with a sealed switch contact block is shown below.



Type 3 Flange Seal



Sealing Wells

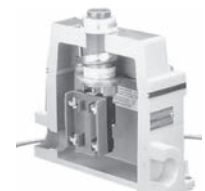

Sealed Switch Contact Blocks



Specifications*

Electrical Ratings	
Contact Ratings	Refer to the contact ratings tables below.
Dielectric Strength	2200V for one minute, 1300V for one minute (Logic Reed)
Electrical Design Life Cycles	1 000 000 at max. rated load, 200 000 at max. rated load (Logic Reed)
Mechanical Ratings	
Vibration	10...2000 Hz 1.52 mm displacement (peak-to-peak) Max./10 G Max. (except Logic Reed)
Shock	1/2 cycle sine wave for 11 ms ≥ 25 G (contact fragility) and no damage at 100 G
Degree of Protection	Type 7 & 9 Explosion Proof (Type 3 and Type 4 ratings available with accessories)
Mechanical Design Life Cycles	
Push Buttons	250 000 minimum
Potentiometers	100 000 minimum
All other devices	200 000 minimum
Contact Operation	Shallow and mini contact blocks: slow double make and break Logic Reed & sealed switch contact blocks: snap-action
Wire Gauge/Terminal Screw Torque	# 18...12 AWG/6...8 lb•in
Typical Operating Forces	
Operators without contact blocks:	Flush, extended, standard mushroom, jumbo mushroom: 2.9 lb max. Jumbo and extended aluminum mushroom head: 3.95 lb maximum Maintained selector switch: 4.0 in•lb maximum
Spring Return Selector Switches:	5 in•lb to stop, 0.2 in•lb to return
Illuminated Push Buttons and Push-to-Test Pilot Lights	5.6 lb maximum
2-Position Push-Pull	9 lb maximum push or pull
3-Position Push-Pull	12 lb maximum push to in position or pull to center position (15 lb maximum pull to out position)
Contact Blocks:	
800T-XA	1 lb
Logic Reed	1 lb maximum
Sealed Switch	3 lb maximum at 0.205 in. plunger travel
Stackable Sealed Switch	1 lb maximum
Environment	
Temperature Range	Operating: -4...+13 °F (-20...+55 °C) Storage: -40...+185 °F (-40...+85 °C)
Note: Operating temperatures below freezing are based on the absence of freezing moisture and liquids.	
Humidity	50% at +104 °F (+40 °C)

* Performance Data — See page Important-3.

* External thread major diameter: 1.034 in. max., 1.024 in. min. Internal thread minor diameter: 0.958 in. min., 0.970 in. max.

Standard Contact Ratings

Maximum thermal continuous current I_{th} 10 A AC/2.5 A DC.
 Bulletin 800H Type 7 & 9 units with 800T-XA contacts have ratings as follows:

Max. Oprtnl. Volts U_e	Utilization Category		Rated Operational Currents		
	IEC	NEMA	Volts U_e	Make	Break
AC 600	AC-15	A600	120...600	7200VA	720VA
			72...120	60 A	720VA
			24...28*	60 A	10 A
DC 600	DC-13	Q600	28...600	69VA	
			24...28*	2.5 A	

* For applications below 24V and 24 mA, PenTUFF™, Logic Reed or stackable sealed switch contacts are recommended.

Sealed Switch Contact Ratings

Maximum continuous current I_{th} 5 A.

Max. Oprtnl. Volts U_e	Utilization Category		Rated Operational Currents		
	IEC	NEMA	Volts U_e	Make	Break
AC 600	AC-15	B600	120...600	3600VA	360VA
			0...120	30 A	3 A
DC 300	DC-13	P300	24...300	138VA	
			0...24	5.0 A	

Stackable Sealed Switch Contact Ratings

Maximum continuous current I_{th} 3 A. Bulletin 800T units have control circuit ratings with sealed switch contact blocks as follows:

Max. Oprtnl. Volts U_e	Utilization Category		Rated Operational Currents		
	IEC	NEMA	Volts U_e	Make	Break
AC 300	AC-15	C300	120...300	1800VA	180VA
			0...120	15 A	1.5 A
DC 150	DC-13	Q150	24...150	69VA	
			0...24	2.5 A	

Logic Reed Contact Ratings

Maximum: 150V AC, 0.15 A, 8 VA and 30V DC, 0.06 A, 1.8 VA.

Should only be used with resistive loads.

PenTUFF™ (Low Voltage) Contact Ratings

Minimum DC: 5V, 1 mA

Maximum thermal continuous current I_{th} 2.5 A AC/1.0 A DC.











Bulletin 800H units with 800T-XAV contacts have ratings as follows:

Max. Oprtnl. Volts U_e	Utilization Category		Rated Operational Currents		
	IEC	NEMA	Volts U_e	Make	Break
AC 300	AC-15	C300	120...300	1800VA	180VA
			0...120	15 A	1.5 A
DC 150	DC-13	R150	24...150	28VA	
			0...24	1.0 A	

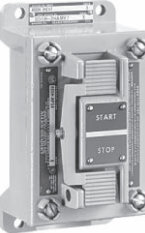
Hazardous Location Push Buttons

Product Selection

Complete Assembled Stations (Supplied with 3/4 in. Dead End Conduit Entry — Cat. No. 800H-1HZX7)

	Operator	Contact Symbol	Contact Action	Legend Marking	Lever Type Actuator*‡	Component Type Buttons*‡
					Cat. No.	Cat. No.
 Cat. No. 800H-1HA7	One Push Button	 1 N.O. 1 N.C.	Momentary	STOP	800H-1HA7	800H-1HA7P
				START	800H-1HB7	800H-1HB7P
				JOG	800H-1HJ7	800H-1HJ7P
				No Legends	800H-1HX7	800H-1HX7P
 Cat. No. 800H-2HA7P	Two Push Buttons	 1 N.O. 1 N.C. Each Button	Momentary	START STOP	800H-2HA7	800H-2HA7P
				FOR REV	800H-2HB7	800H-2HB7P
				RAISE LOWER	800H-2HD7	800H-2HD7P
				OPEN CLOSE	800H-2HF7	800H-2HF7P
				No Legends	800H-2HX7	800H-2HX7P
 Cat. No. 800H-2HAM7	2-Position Selector Switch	 1 N.O. 1 N.C.	Maintained	START STOP	800H-2HAM7	—
				ON OFF	800H-2HCM7	800H-R2HC7
				OPEN CLOSE	800H-2HGM7	800H-R2HG7
				RUN STOP	800H-2HJM7	—
				HAND AUTO	800H-2HLM7	800H-R2HA7
				No Legends	800H-2HXM7	800H-R2HX7
 Cat. No. 800H-R3HA7	3-Position Selector Switch	 1 N.O. 1 N.C.	—	HAND OFF AUTO	—	800H-R3HA7
				No Legends	—	800H-R3HX7
 Cat. No. 800H-2HAD10R7	One Pilot Light, Dual Push Buttons	 120V AC/DC Full Volt./Red	—	No Legend START STOP	—	800H-2HAD10R7
				 1 N.O. 1 N.C.	Marking other than listed - consult your local Allen-Bradley distributor	—

* Operators have integral padlocking attachment.

* STOP is extended red, START is flush green, all others are flush black.

‡ Supplied with standard shallow contact blocks. For stations with sealed switch contacts, change Bulletin number from 800H to 800R. A deep enclosure is required.

Momentary Contact Push Button Units, Non-Illuminated



*Flush Head Unit
 Cat. No. 800H-AP1A*



*Extended Head Unit
 Cat. No. 800H-BP6B*



*Mushroom Head Unit
 Cat. No. 800H-DP6A*

Contact Type	Button Color	Flush Head	Extended Head	Mushroom Head
		Cat. No.*	Cat. No.*	Cat. No.*
No Contact	Green	800H-AP1	800H-BP1	800H-DP1
	Black	800H-AP2	800H-BP2	800H-DP2
	Red	800H-AP6	800H-BP6	800H-DP6
1 N.O.	Green	800H-AP1D1	800H-BP1D1	800H-DP1D1
	Black	800H-AP2D1	800H-BP2D1	800H-DP2D1
	Red	800H-AP6D1	800H-BP6D1	800H-DP6D1
1 N.C.	Green	800H-AP1D2	800H-BP1D2	800H-DP1D2
	Black	800H-AP2D2	800H-BP2D2	800H-DP2D2
	Red	800H-AP6D2	800H-BP6D2	800H-DP6D2
1 N.O. - 1 N.C.	Green	800H-AP1A	800H-BP1A	800H-DP1A
	Black	800H-AP2A	800H-BP2A	800H-DP2A
	Red	800H-AP6A	800H-BP6A	800H-DP6A
2 N.O. - 2 N.C.	Green	800H-AP1B	800H-BP1B	800H-DP1B
	Black	800H-AP2B	800H-BP2B	800H-DP2B
	Red	800H-AP6B	800H-BP6B	800H-DP6B

* For long barrel versions, add an **L** to the cat. no. **Example:** Cat. No. 800HL-AP1.

Dual Momentary Contact Push Button Units

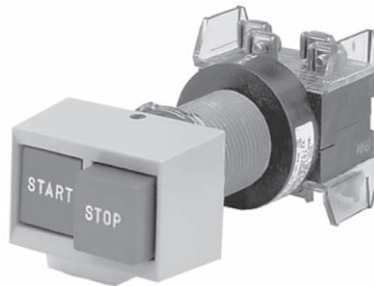

*Dual Push Button Unit
 Cat. No. 800H-DPH16AAX64*

Contact Arrangement		Legend Marking		Cat. No.*
Type	Contacts	Left	Right	
2 N.O. - 2 N.C.		START (Flush/Green)	STOP (Extended/Red)	800H-DPH16AAX64
		ON (Flush/Black)	OFF (Flush/Black)	800H-DPH22AAX50
	OPEN (Flush/Black)	CLOSE (Flush/Black)	800H-DPH22AAX57	
	UP (Flush/Black)	DOWN (Flush/Black)	800H-DPH22AAX66	
	Blank (Flush/Black)	Blank (Flush/Black)	800H-DPH22AAXX	

* For long barrel versions, add an **L** to the cat. no. **Example:** Cat. No. 800HL-DPH16AAX64.

Hazardous Location Push Buttons

Product Selection

Momentary Contact Push Button Units, Non-Illuminated

800 H - AP 1 A
 a b c d e

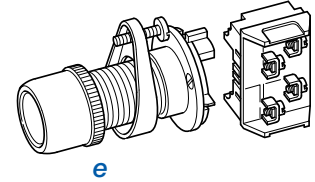

a

Barrel Type	
Code	Description
H	Standard barrel length
HL	Long barrel

b

Operator Type	
Code	Description
AP	Flush head
BP	Extended head
DP	Mushroom head
DPX	Mushroom head less color cap

c

Color Cap	
Code	Description
Blank	Used only when ordering operator type DPX (Table b)
1	Green
2	Black
3	Orange
4	Grey
6	Red
7	Blue
9	Yellow

d

Special Mushroom Head	
Code	Description
Blank	No special head
J	Jumbo mushroom head — plastic
L	Jumbo mushroom head — metal

Note: Special mushroom head options only apply to mushroom head operator type DP (Table b).

e

Contact Block(s)*	
Standard	
Code	Description
Blank	No contacts
D1	1 N.O.
D2	1 N.C.
D5	1 N.O. (Mini)
D6	1 N.C. (Mini)
A2	2 N.O.
A4	2 N.C.
A	1 N.O. - 1 N.C.
B	2 N.O. - 2 N.C.
H	3 N.O. - 3 N.C.
C	4 N.O. - 4 N.C.
PenTUFF (Low Voltage)	
Code	Description
D1V	1 N.O.
D2V	1 N.C.
AV	1 N.O. - 1 N.C.
BV	2 N.O. - 2 N.C.
HV	3 N.O. - 3 N.C.
CV	4 N.O. - 4 N.C.

Dual Push Button Units

800 H - DP H 16 AAXX 64
 a b c d e f

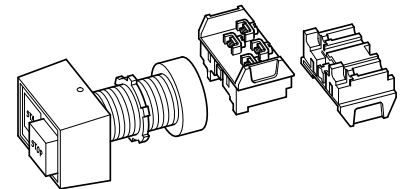

a

Barrel Type	
Code	Description
H	Standard barrel
HL	Long barrel

b

Operator Type	
Code	Description
DP	Dual push button

c

Mounting	
Code	Description
H	Horizontal
B	Vertical

d

Color of Button	
Code	Description
16	Left green flush/right red extended
22	Left black flush/right black flush

e

Contact Block(s)*		
Code	Contact Arrangement	
	Left button for horizontal Top button for vertical	Right button for horizontal Bottom button for vertical
AAXX	1 N.O. - 1 N.C.	1 N.O. - 1 N.C.
AAAA	2 N.O. - 2 N.C.	2 N.O. - 2 N.C.

f

Marking		
Code	Description	
	Left button for horizontal Top button for vertical	Right button for horizontal Bottom button for vertical
Blank	No mark specified	No mark specified
64	START	STOP
50	ON	OFF
51	FORWARD	REVERSE
57	OPEN	CLOSE
66	UP	DOWN
99*	Marking specified	Marking specified

* For sealed switch and Logic Reed contact blocks, see page 10-175.

* To order with special marking, specify marking; seven characters maximum per button, single line only.

Momentary Contact Push Button Units, Illuminated

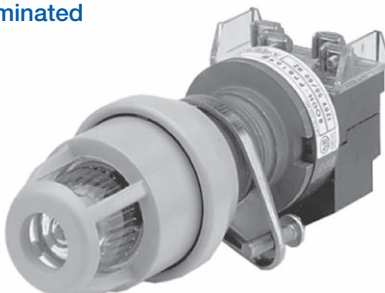

Extended Head with Guard
Cat. No. 800H-PPB16M

Type	Lamp	Supply Voltage	Lens Color*	Extended Head with Guard
				Cat. No.†‡
Operator only ➤				800H-QPB00XX
Full Voltage	Incandescent	24V AC/DC	Multi-color kit	800H-QPB24M
		120V AC/DC		800H-QPB10M
	No lamp	0...250V AC/DC	No lens	800H-QPBN25
Universal	LED	12...130V AC/DC	Multi-color kit	800H-QPBH2M
Transformer	Incandescent	120V AC 50/60 Hz	Multi-color kit	800H-PPB16M
	LED			800H-PPBH16M
	No lamp		No lens	800H-PPBN16

- * Units ship with multi-color insert packet including amber, blue, green, red, and white.
- † For long barrel versions, add an **L** to the cat. no. **Example:** Cat. No. 800HL-QPB2M.
- ‡ Includes as standard one Cat. No. 800T-XA (1 N.O./1 N.C.) contact block.
- Operator only supplied without power module, lamp, lens cap, or contact blocks.

Potentiometer Units‡



Potentiometer Unit
Cat. No. 800H-UP24

Resistance	Potentiometer*	Resistance	Potentiometer*
	Cat. No.‡		Cat. No.‡
Operator Only (without Resistive Element)	800H-NP37*	2.5 kΩ	800H-UP19
		5 kΩ	800H-UP24
1 kΩ	800H-UP13	10 kΩ	800H-UP29

- * Rated for 300V AC/DC, 2W maximum.
- † For use with Type J potentiometers having a shaft length of 7/8 in. (22.2 mm) and a shaft diameter of 1/4 in. (6.3 mm).
- ‡ Single-turn operation with 312° rotation.
- ‡ For long barrel versions, add an **L** to the cat. no. **Example:** Cat. No. 800HL-UP13.

Hazardous Location Push Buttons

Product Selection

Momentary Contact Push Button Units, Illuminated

800 H - PPB H 16 M
 a *b* *c* *d* *e* *f*

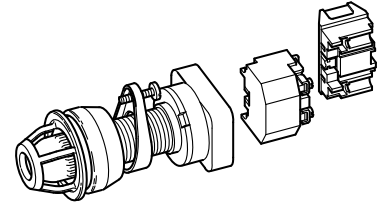

a

Operator Type	
Code	Description
H	Standard barrel length
HL	Long barrel

b

Power Module Type	
Code	Description
PPB	Transformer (or dual input)
QPB	Full voltage/Universal

c

Illumination Options	
Code	Description
Blank	Incandescent
H	LED
Dual Input	
D	Diode type, incandescent§
T	Transformer — relay type, incandescent
TH	Transformer — relay type, LED

d

Voltage	
Transformer	
Code	Description
16	120V AC 50/60 Hz
26	240V AC 50/60 Hz
46	480V AC 50/60 Hz
56	600V AC 50/60 Hz
Full Voltage — Incandescent	
24	24V AC/DC
10	120V AC/DC
20	240V AC/DC
Universal — LED	
2	12...130V AC/DC
Dual Input	
16	120V AC
24	24V AC/DC‡

e

Lens Color	
Code	Color
Blank	No lens, with standard contacts 1 N.O. - 1 N.C.
X	No lens if ordering any contacts other than standard 1 N.O. - 1 N.C.
M	Multi-color*

f

Contact Block(s) †	
Standard	
Code	Description
Blank	1 N.O. - 1 N.C.
X	No contacts
D1	1 N.O.
D2	1 N.C.
A2	2 N.O.
A4	2 N.C.
PenTUFF (Low Voltage)	
Code	Description
D1V	1 N.O.
D2V	1 N.C.
AV	1 N.O. - 1 N.C.

§ Diode type dual input provides circuit isolation via opposing diodes. Not recommended for use with solid-state outputs and neon indicators.

‡ Dual input diode only.

* Multi-color insert packet includes amber, blue, green, red, and white.





† For sealed switch and Logic Reed contact blocks, see page 10-175.



2-Position Push-Pull Units, Non-Illuminated



2-Position Push-Pull
 Cat. No. 800H-FPX6A5

Contact Type	Operator Position			Button Color	Push-Pull Cat. No.*
	 Maintained	 Maintained			
	Out	In			
 N.C.L.B.	X	O		Red	800H-FPX6D4
 N.O. - N.C.L.B.	O X	X O		Red	800H-FPX6A1
 N.C.L.B. - N.C.L.B.	X X	O O		Red	800H-FPX6A5





Note: X = Closed/O = Open





* For long barrel versions, add an **L** to the cat. no. **Example:** Cat. No. 800HL-FPX6D4.

3-Position Push-Pull Units, Non-Illuminated



3-Position Push-Pull
 Cat. No. 800H-FPXM6A7

Contact Type	Operator Position			Button Color	Push-Pull Cat. No.*
	 Momentary	 Maintained	 Maintained		
	Out	Center	In		
 N.C. - N.C.L.B.	X X	O X	O O	Red	800H-FPXM6A7

Contact Type	Operator Position			Button Color	Push-Pull Cat. No.*
	 Momentary	 Maintained	 Momentary		
	Out	Center	In		
 N.C. - N.C.L.B.	X X	O X	O O	Red	800H-FPXM6A7

Note: X = Closed/O = Open

* For long barrel versions, add an **L** to the cat. no. **Example:** Cat. No. 800HL-FPXM6A7.

Hazardous Location Push Buttons

Product Selection

2-Position Push-Pull Units, Non-Illuminated

800 H - FPX 1 A1
 a b c d e

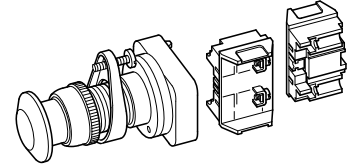

a

Barrel Type	
Code	Description
H	Standard barrel length
HL	Long barrel

d

Color Cap	
Code	Color
Blank	No cap
1	Green
2	Black
4	Grey (silver)
6	Red
7	Blue
9	Yellow (gold)

b

Operator Type	
Code	Description
FPX	Push-pull unit

e

Contact Block(s)			
Standard			
Code	Operator Position		Description
	Out	In	
Blank	—	—	No contacts
A1	O X	X O	1 N.O. - 1 N.C.L.B.*
A5	X X	O O	2 N.C.L.B.*
D1	O	X	1 N.O.
D4	X	O	1 N.C.L.B.*
PenTUFF (Low Voltage)			
D1V	O	X	1 N.O.
AV	O X	X O	1 N.O. - 1 N.C.

Note: X = Closed/O = Open.

c

Head Type	
Code	Description
Blank	Mushroom head
J	Jumbo mushroom head*

* Normally closed late break contact. When button is pushed from the OUT to the IN position, the mechanical detent action of the operator occurs before electrical contacts change state. When the button is pulled from the IN to the OUT position, the electrical contacts change state before the mechanical detent occurs.

3-Position Push-Pull Units, Non-Illuminated

800 H - FPX M 1 A7
 a b c d e f

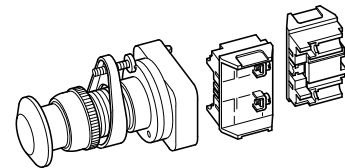

a

Barrel Type	
Code	Description
H	Standard barrel length
HL	Long barrel

d

Operator Function			
Code	Operator Position		
	Out	Center	In
M	Momentary	Maintained	Maintained
N	Momentary	Maintained	Momentary

b

Operator Type	
Code	Description
FPX	Push-pull unit

f

Contact Block(s)				
Standard				
Code	Operator Position			Description
	Out	Ctr.	In	
Blank	—	—	—	No contacts
A	O X	O O	X O	1 N.O. - 1 N.C.
A1	O X	O X	X O	1 N.O. - 1 N.C.L.B.
A7	X X	O X	O O	1 N.C. - 1 N.C.L.B.
B6	X X	O X	O O	2 N.C. - 2 N.C.L.B.
PenTUFF (Low Voltage)				
AV	O X	O O	X O	1 N.O. - 1 N.C.

Note: X = Closed/O = Open.

c

Head Type	
Code	Description
Blank	Mushroom head
J	Jumbo mushroom head*

e



Color Cap	
Code	Color
Blank	No cap
1	Green
2	Black
4	Grey (silver)
6	Red
7	Blue
9	Yellow (gold)

* Not valid with color cap option **Blank** (no cap).

2-Position Push-Pull Units, Illuminated



Illuminated 2-Position Push-Pull
Cat. No. 800H-FPXP16RA1





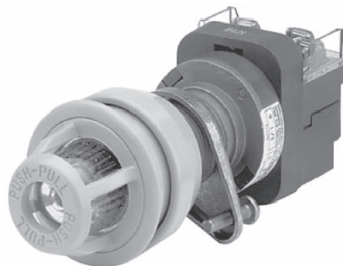

Type	Lamp Type	Supply Voltage	Lens Color*	Contacts	Operator Position		Cat. No.*
							
					Out	In	
Operator only ‡					No contacts		800H-FPXQ00
Full voltage	Incandescent	24V AC/DC	Multi-color kit	N.O. - N.C.L.B.	O	X	800H-FPXQ24MA1
		120V AC/DC			X	O	800H-FPXQ10MA1
	No lamp	0...250V AC/DC	No lens	No contacts		800H-FPXQN25	
Universal	LED	12...130V AC/DC	Multi-color kit	N.O. - N.C.L.B.	O X	X O	800H-FPXQH2MA1
Transformer	Incandescent	120V AC, 50/60 Hz	Multi-color kit	N.O. - N.C.L.B.	O	X	800H-FPXP16MA1
	LED				X	O	800H-FPXP16MA1
	No lamp		No lens	No contacts			

Note: X = Closed/O = Open.

3-Position Push-Pull Units, Illuminated



Illuminated 3-Position Push-Pull
Cat. No. 800H-FPXM16RA7

Operator Position (800H-FPXM)				Operator Position (800H-FPXN)			
 Momentary				 Momentary			
 Maintained				 Maintained			
 Maintained				 Momentary			
Contacts	Out	Center	In	Contacts	Out	Center	In
N.C. - N.C.L.B.	X	O	O	N.C. - N.C.L.B.	X	O	O
	X	X	O		X	X	O

Type	Lamp Type	Supply Voltage	Lens Color*	Cat. No.*	
Operator only ‡				800H-FPXM00	800H-FPXN00
Full voltage	Incandescent	24V AC/DC	Multi-color kit	800H-FPXM24MA7	800H-FPXN24MA7
		120V AC/DC		800H-FPXM10MA7	800H-FPXN10MA7
	No lamp	0...250V AC/DC	No lens	800H-FPXM25	800H-FPXN25
Universal	LED	12...130V AC/DC	Multi-color kit	800H-FPXM2MA7	800H-FPXN2MA7
Transformer	Incandescent	120V AC, 50/60 Hz	Multi-color kit	800H-FPXM16MA7	800H-FPXN16MA7
	LED			800H-FPXM16MA7	800H-FPXN16MA7
	No lamp		No lens	800H-FPXM16	800H-FPXN16

Note: X = Closed/O = Open

* Units ship with multi-color insert packet including amber, blue, green, red, and white.

‡ For long barrel versions, add an **L** to the cat. no. **Example:** Cat. No. 800HL-FPXQH2MA1.

‡ Operator only supplied without power module, lamp, lens cap, or contact blocks.

Hazardous Location Push Buttons

Product Selection

2- and 3-Position Push-Pull Units, Illuminated

800 H - FPX PH 16 M A1
 a b c d e f g

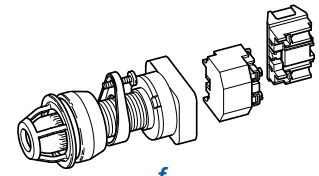

a

Barrel Type	
Code	Description
H	Standard barrel length
HL	Long barrel

b

Operator Type	
Code	Description
FPX	Push-pull unit

c

Operator Function			
2-Position			
Code	Description		
Blank	Push-pull		
3-Position			
Code	Operator Position		
M	Mom.	Main.	Main.
N	Mom.	Main.	Mom.

Note: Mom. - Momentary
Main. - Maintained

d

Illumination Options	
Transformer	
Code	Description
P	Incandescent
PH	LED
Full Voltage	
Code	Description
Q	Incandescent
QH	Universal LED
Dual Input	
Code	Description
D	Dual input — diode§
DT	Dual input — transformer relay
DTH	Dual input transformer — relay LED

e

Voltage	
Transformer	
Code	Description
16	120V AC 50/60 Hz
26	240V AC 50/60 Hz
46	480V AC 50/60 Hz
56	600V AC 50/60 Hz
Full Voltage — Incandescent	
Code	Description
24	24V AC/DC
10	120V AC/DC
20	240V AC/DC
Universal — LED	
Code	Description
2	12...130V AC/DC
Dual Input	
Code	Description
16	120V AC
24	24V AC/DC+

f

Color Cap	
Code	Color
Blank	No lens with no contacts
X	No lens with contacts
M	Multi-color*

g

Contact Blocks	
Standard	
Code	Color
Blank	No contacts
D1	1 N.O.
D4	1 N.C.L.B.‡
A	1 N.O. - 1 N.C.
A1	1 N.O. - 1 N.C.L.B.‡
A2	2 N.O.
A5	2 N.C.L.B.
A7	1 N.C. - 1 N.C.L.B.‡
PenTUFF (Low Voltage)	
Code	Description
D1V	1 N.O.
D2V	1 N.C.
AV	1 N.O. - 1 N.C.
Logic Reed	
Code	Color
D1R	1 N.O.
D2R	1 N.C.
AR	1 N.O. - 1 N.C.
A2R	2 N.O.
A4R	2 N.C.

Table 1. Target Selection

g Code	2-Position		Contact Description	3-Position			g Code
A, AV, R	O X	X O	N.O. N.C.	O X	O O	X O	A, AV, AR
A1	O X	X O	N.O. N.C.L.B.	O X	O X	X O	A1
A2	O X	O X	N.O. N.O.	— —	— —	— —	—
A5	X O	X O	N.C.L.B. N.C.L.B.	— —	— —	— —	—
—	— —	— —	N.C. N.C.L.B.	X X	O X	O O	A7
D1, D1V, D1R	O	X	N.O.	—	—	—	—
D4	X	O	N.C.L.B.	—	—	—	—

10

* Multi-color insert packet includes amber, blue, green, red, and white.
 § Diode type dual input provides circuit isolation via opposing diodes. Not recommended for use with solid-state outputs and neon indicators.
 ‡ Normally closed late break contact. When button is pushed from the OUT to the IN position, the mechanical detent action of the operator occurs before electrical contacts change state. When the button is pulled from the IN to the OUT position, the electrical contacts change state before the mechanical detent occurs.
 † Dual input diode only.

2-Position Selector Switch Units, Non-Illuminated



Standard Knob Operator
 Cat. No. 800H-HP2KB6AXXX



Knob Lever Operator
 Cat. No. 800H-HP17KB6AXXX



Metal Wing Lever Operator
 Cat. No. 800H-HP11KB6AXXX

Contact Type	Operator Position		Contact Action M = Maintained S = Spring Return	Standard Knob	Knob Lever	Wing Lever
				Cat. No.‡	Cat. No.‡	Cat. No.‡
No Contacts	—	—	M M	800H-HP2KB6	800H-HP17KB6	800H-HP11KB6
			S→M*	800H-HP4KL8	800H-HP4KL8	800H-HP4KL8
1 N.O.	O	X	M M	800H-HP2KB6DXXX	800H-HP17KB6DXXX	800H-HP11KB6DXXX
			S→M*	800H-HP4KL8DXXX	800H-HP18KL8DXXX	800H-HP15KL8DXXX
			M←S	800H-HP5KL8DXXX	800H-HP19KL8DXXX	800H-HP16KL8DXXX
1 N.O. - 1 N.C.	O X	X O	M M	800H-HP2KB6AXXX	800H-HP17KB6AXXX	800H-HP11KB6AXXX
			S→M*	800H-HP4KL8AXXX	800H-HP18KL8AXXX	800H-HP15KL8AXXX
			M←S	800H-HP5KL8AXXX	800H-HP19KL8AXXX	800H-HP16KL8AXXX
2 N.O. - 2 N.C.	O X O X	X O X O	M M	800H-HP2KB6AAXX	800H-HP17KB6AAXX	800H-HP11KB6AAXX
			S→M*	800H-HP4KL8AAXX	800H-HP18KL8AAXX	800H-HP15KL8AAXX
			M←S	800H-HP5KL8AAXX	800H-HP19KL8AAXX	800H-HP16KL8AAXX

Note: X = Closed/O = Open



2-Position Cylinder Lock Operator
 Cat. No. 800H-HP31KB6AXXX

Contact Type	Operator Position		Contact Action M = Maintained S = Spring Return	Cylinder Lock		
				Key Removal Left*	Key Removal Right*	Key Removal Both*
				Cat. No.‡	Cat. No.‡	Cat. No.‡
No Contacts	—	—	M M	800H-HP31KB6	800H-HP32KB6	800H-HP33KB6
			M←S	800H-HP48KL8	—	—
1 N.O.	O	X	M M	800H-HP31KB6DXXX	800H-HP32KB6DXXX	800H-HP33KB6DXXX
			S→M*	—	800H-HP42KL8DXXX	—
			M←S	800H-HP48KL8DXXX	—	—
1 N.O. - 1 N.C.	O X	X O	M M	800H-HP31KB6AXXX	800H-HP32KB6AXXX	800H-HP33KB6AXXX
			S→M*	—	800H-HP42KL8AXXX	—
			M←S	800H-HP48KL8AXXX	—	—
2 N.O. - 2 N.C.	O X O X	X O X O	M M	800H-HP31KB6AAXX	800H-HP32KB6AAXX	800H-HP33KB6AAXX
			S→M*	—	800H-HP42KL8AAXX	—
			M←S	800H-HP48KL8AAXX	—	—

Note: X = Closed/O = Open

* Target tables are reversed from those shown.

* Key removable from maintained positions only. Devices supplied with 2 keys. Replacement part number for standard D018 key is X-181170.

‡ For long barrel versions, add an L to the cat. no. Example: Cat. No. 800HL-HP48KL8.

Hazardous Location Push Buttons

Product Selection

2-Position Selector Switch Units, Non-Illuminated

800 H - HP A 2 KB6 AXXX (Knob/Wing Lever)

a *b* *c* *d* *e* *f*

800 H - HP 31 KB6 AXXX (Cylinder Lock)

a *b* *c*₁ *d*₁ *e* *f*

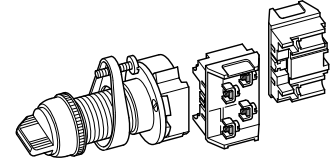

a

Barrel Type	
Code	Description
H	Standard barrel length
HL	Long barrel

b

Number of Positions	
Code	Description
HP	2-position

c

Knob Insert Colors*	
Code	Color
Blank	White
X	Packet of colored inserts*

Metal Wing Lever Colors	
Code	Color
A	Red
Blank	Grey

c₁

Key Removal Position	
Maintained	
Code	Operator Function
31	Key removal — left
32	Key removal — right
33	Key removal — both

Spring Return From Left	
Code	Operator Function
42	Key removal — right ‡

Spring Return From Right	
Code	Operator Function
48	Key removal — left

d

Operator Type and Function	
Standard Knob	
Code	Operator Function
2	Maintained
4	Spring return from left ‡
5	Spring return from right

Knob Lever	
Code	Operator Function
17	Maintained
18	Spring return from left ‡
19	Spring return from right

Metal Wing Lever	
Code	Operator Function
11	Maintained
15	Spring return from left ‡
16	Spring return from right

d₁

Optional Keys			
Code	D Series Key No.	Code	T Series Key No.
Blank	D018 (std. key)	15	T112
03	D020	16	T115
04	D025	17	T324
05	D335	18	T382
06	D429	19	T404
07	D461	20	T171
08	D111	21	T484
09	D587	22	T547
10	D682	23	T569
11	D713	24	T692
12	D900	25	T752
13	D992	26	T178
14	D118	—	—

e

Cam Option	
Code	Description
KB6	Cam for maintained operators
KL8	Cam for spring return operators

f

Contact Block(s)			
Standard			
Code	Contact Configuration	2-Position	
Blank	No contacts	—	—
DXXX	1 N.O.	O	X
EXXX	1 N.C.	X	O
MXXX	2 N.O.	O	X
		O	X
NXXX	2 N.C.	X	O
		X	O
AXXX	1 N.O. - 1 N.C.	O	X
		X	O
AAXX	2 N.O. - 2 N.C.	O	X
		X	O
		O	X
		X	O

PenTUFF (Low Voltage)			
Code	Contact Configuration	2-Position	
HXXX	1 N.O.	O	X
UXXX	1 N.C.	X	O
FXXX	1 N.O. - 1 N.C.	O	X
		X	O
FFXX	2 N.O. - 2 N.C.	O	X
		X	O
		O	X
		X	O

Note: X = Closed/O = Open.

* Each standard and knob lever operator is factory assembled with a white insert. Other colors are available, factory assembled, if ordered in quantities of 10 or more.
 * One insert of each color (blue, green, orange, red, and yellow).
 ‡ Target tables are reversed from those shown.

3-Position Selector Switch Units, Non-Illuminated



Standard Knob Operator
 Cat. No. 800H-JP2KB7AXXX



Knob Lever Operator
 Cat. No. 800H-JP17KB7AXXX



Metal Wing Lever Operator
 Cat. No. 800H-JP11KB7AXXX

Contact Type	Operator Position			M = Maintained S = Spring Return	Standard Knob	Knob Lever	Metal Wing Lever
					Cat. No.‡	Cat. No.‡	Cat. No.‡
No Contacts	—	—	—	M M M	800H-JP2KB7	800H-JP17KB7	800H-JP11KB7
				S→M M	800H-JP4KB7	800H-JP18KB7	800H-JP15KB7
				M M←S	800H-JP5KB7	800H-JP19KB7	800H-JP16KB7
				S→M←S	800H-JP91KB7	800H-JP20KB7	800H-JP141KB7
	O X	O O	X O	M M M	800H-JP2KB7AXXX	800H-JP17KB7AXXX	800H-JP11KB7AXXX
				S→M M	800H-JP4KB7AXXX	800H-JP18KB7AXXX	800H-JP15KB7AXXX
				M M←S	800H-JP5KB7AXXX	800H-JP19KB7AXXX	800H-JP16KB7AXXX
				S→M←S	800H-JP91KB7AXXX	800H-JP20KB7AXXX	800H-JP141KB7AXXX
	O X O X	O O O O	X O X O	M M M	800H-JP2KB7AAXX	800H-JP17KB7AAXX	800H-JP11KB7AAXX
				S→M M	800H-JP4KB7AAXX	800H-JP18KB7AAXX	800H-JP15KB7AAXX
				M M←S	800H-JP5KB7AAXX	800H-JP19KB7AAXX	800H-JP16KB7AAXX
				S→M←S	800H-JP91KB7AAXX	800H-JP20KB7AAXX	800H-JP141KB7AAXX

Note: X = Closed/O = Open



3-Position Cylinder Lock Operator
 Cat. No. 800H-JP42KB7AXXX

Contact Type	Operator Position			M = Maintained S = Spring Return	Cylinder Lock		
					Key Removal Left	Key Removal Center	Key Removal All*
					Cat. No.‡	Cat. No.‡	Cat. No.‡
No Contacts	O	X	X	M M M	800H-JP41KB7	800H-JP42KB7	800H-JP44KB7
				S→M*	—	800H-JP50KB7	800H-JP51KB7
				M←S	800H-HP5KL8DXXX	800H-JP38KB7	800H-JP73KB7
				M M	—	800H-JP631KB7	—
	O X	O O	X O	M M M*	800H-JP41KB7AXXX	800H-JP42KB7AXXX	800H-JP44KB7AXXX
				M←S	—	800H-JP50KB7AXXX	800H-JP51KB7AXXX
				M M←S	800H-JP69KB7AXXX	800H-JP38KB7AXXX	800H-JP73KB7AXXX
				S→M←S	—	800H-JP631KB7AXXX	—

Note: X = Closed/O = Open

* Key removable in maintained positions only.

‡ For long barrel versions, add an **L** to the cat. no. **Example:** Cat. No. 800HL-JP41KB7.

Hazardous Location Push Buttons

Product Selection

3-Position Selector Switch Units, Non-Illuminated

800 **H** - **JP** **2** **KB7** **AAXX** (Knob/Wing Lever)
a *b* *c* *d* *e* *f*

800 **H** - **JP** **41** **KB7** **AAXX** (Cylinder Lock)
a *b* *c*₁ *d*₁ *e* *f*

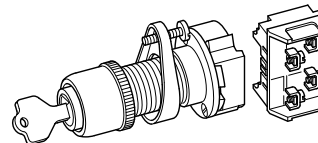

a

Barrel Type	
Code	Description
H	Standard barrel length
HL	Long barrel

b

Number of Positions	
Code	Description
JP	3-position

c

Knob Insert Colors*	
Code	Color
Blank	White knob insert or cylinder lock operator
X	Packet of colored inserts*

Metal Wing Lever Colors	
Code	Color
A	Red
Blank	Grey

c₁

Cylinder Lock Operators	
Maintained Position	
Code	Locking Position
41	Left
42	Center
43	Right
44	All
45	Left and center
46	Right and left
47	Right and center

d

Knob/Lever Type Operators	
Standard Knob	
Code	Operator Function
2	Maintained
4	Spring return from left
5	Spring return from right
91	Spring return from both
Knob Lever	
Code	Operator Function
17	Maintained
18	Spring return from left
19	Spring return from right
20	Spring return from both

d₁

Operator Type/Function‡	
Standard Knob	
Code	Key No.
Blank	D018 (standard key)

d

Knob/Lever Type Operators	
Standard Knob	
Code	Operator Function
2	Maintained
4	Spring return from left
5	Spring return from right
91	Spring return from both

e

Cam Option	
Code	Description
KB7	Standard cam KB7
KA1	Cam KA1
KA7	Cam KA7

Note: For additional Cam descriptions, see Table 5.

f

Contact Block Option	
Code	Description
Blank	No contacts
AXXX	Two contact targets for a given cam as shown in the W (white side) column of Table 5.
AAXX	Two contact targets for a given cam as shown in the W (white side) column of Table 1 and 2 contact targets for the same cam as shown in the B (black side) column of Table 5. (One Cat. No. 800T-XA contact block per side. Two contact blocks total.)
AAAA	Four contact targets for a given cam as shown in the W (white side) column of Table 5 and 4 contact targets for the same cam as shown in the B (black side) column of Table 5. (Two Cat. No. 800T-XA contact blocks per side. Four contact blocks total.)

Table 5. Cam and Contact Block Functionality Table

Contact Block Suffix Code	Contact Block Side	Circuits	Cam Codes																												
			KB7 (Std.)	KA1	KA7	KC1	KC7	KD7	KE7	KQ1	KQ7	KR1	KR7	KT1	KT7	KU7															
A	White	1	X	O	O	X	O	O	O	X	O	O	X	X	O	O	O	X	X	O	O	X	X	O	O	X	O	O	X	O	O
	Black	2	O	O	X	O	X	O	O	X	O	O	X	O	O	X	O	O	X	X	O	X	O	X	O	X	O	O	X	O	O
B	White	3	X	O	O	X	O	O	X	O	O	X	X	O	O	X	X	O	X	X	O	X	O	X	O	X	O	O	X	O	O
	Black	4	O	O	X	O	X	O	X	O	O	X	O	O	X	O	O	X	X	O	X	O	X	O	X	O	O	X	O	O	
C	White	5	X	O	O	X	O	O	X	O	O	X	X	O	O	X	X	O	X	X	O	X	O	X	O	X	O	O	X	O	O
	Black	6	O	O	X	O	X	O	X	O	O	X	O	O	X	O	O	X	X	O	X	O	X	O	X	O	O	X	O	O	

Note: X = Closed/O = Open

- * Each standard and knob lever operator is factory assembled with a white insert. Other colors available, factory assembled, if ordered in quantities of 10 or more.
- ⊛ One insert of each color (blue, green, orange, red, and yellow).
- ‡ For additional keys, see page 10-164.
- § Wing levers are not suitable with KE7 cam code.



4-Position Selector Switch Units, Non-Illuminated



Standard Knob Operator
 Cat. No. 800H-NP2KF4AAXX



Knob Lever Operator
 Cat. No. 800H-NP17KF4AAXX



Metal Wing Lever Operator
 Cat. No. 800H-NP11KF4AAXX

Contact Type	Operator Position				M = Maintained S = Spring Return	Standard Knob	Knob Lever	Metal Wing Lever
						Cat. No.‡	Cat. No.‡	Cat. No.‡
No Contacts	—	—	—	—	M M M M	800H-NP2KF4	800H-NP17KF4	800H-NP11KF4
					S→M M M	800H-NP3KF4	800H-NP29KF4	800H-NP13KF4
					M M M←S	800H-NP9KF4	800H-NP30KF4	800H-NP14KF4
	X	O	O	O	M M M M	800H-NP2KF4AAXX	800H-NP17KF4AAXX	800H-NP11KF4AAXX
	O	X	O	O	S→M M M	800H-NP3KF4AAXX	800H-NP29KF4AAXX	800H-NP13KF4AAXX
	O	O	X	O	M M M←S	800H-NP9KF4AAXX	800H-NP30KF4AAXX	800H-NP14KF4AAXX
	O	O	O	X				

Note: X = Closed/O = Open



Cylinder Lock Operator
 Cat. No. 800H-NP32KF4AAXX

Contact Type	Operator Position				M = Maintained S = Spring Return	Cylinder Lock		
						Key Removal Position 2	Key Removal Position 3	Key Removal All*
						Cat. No.‡	Cat. No.‡	Cat. No.‡
No Contacts	—	—	—	—	M M M M	800H-NP32KF4	800H-NP33KF4	800H-NP61KF4
					S→M M M	800H-NP132KF4	800H-NP133KF4	800H-NP154KF4
					M M M←S	800H-NP232KF4	800H-NP233KF4	800H-NP251KF4
	X	O	O	O	M M M M	800H-NP32KF4AAXX	800H-NP33KF4AAXX	800H-NP61KF4AAXX
	O	X	O	O	S→M M M	800H-NP132KF4AAXX	800H-NP133KF4AAXX	800H-NP154KF4AAXX
	O	O	X	O	M M M←S	800H-NP232KF4AAXX	800H-NP233KF4AAXX	800H-NP251KF4AAXX
	O	O	O	X				

Note: X = Closed/O = Open

* Key removable in maintained positions only.

‡ For long barrel versions, add an **L** to the cat. no. **Example:** Cat. No. 800HL-NP32KF4.

Hazardous Location Push Buttons

Product Selection

4-Position Selector Switch Units, Non-Illuminated

800 H - NP 2 KF4 AAXX (Knob/Wing Lever)

a *b* *c* *d* *e* *f*

800 H - NP 31 KF4 AAXX (Cylinder Lock)

a *b* *c*₁ *d*₁ *e* *f*

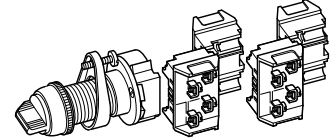

a

Barrel Type	
Code	Description
H	Standard barrel length
HL	Long barrel

b

Number of Positions	
Code	Description
NP	4-position

c

Knob Insert Colors*	
Code	Color
Blank	White
X	Packet of colored inserts*

Metal Wing Lever Colors	
Code	Color
A	Red
Blank	Grey

c₁

Key Removal Position and Operator Function	
Maintained	
Code	Operator Function
31	Key removal position 1
32	Key removal position 2
33	Key removal position 3
34	Key removal position 4
61	Key removal all positions

c₁ (cont'd)

Key Removal Position and Operator Function	
Spring Return From Position 1 to Position 2	
Code	Operator Function
132	Key removal position 2
133	Key removal position 3
134	Key removal position 4
154	Key removal positions 2, 3, and 4

Spring Return From Position 1 to Position 2	
Code	Operator Function
231	Key removal position 1
232	Key removal position 2
233	Key removal position 3
251	Key removal positions 1, 2, and 3

d

Operator Function and Knob Type	
Standard Knob	
Code	Operator Function
2	Maintained
3	Spring return from position 1 to position 2
9	Spring return from position 4 to position 3

Knob Lever	
Code	Operator Function
17	Maintained
29	Spring return from position 1 to position 2
30	Spring return from position 4 to position 3

d (cont'd)

Operator Function and Knob Type	
Metal Wing Lever	
Code	Operator Function
11	Maintained
13	Spring return from position 1 to position 2
14	Spring return from position 4 to position 3

d₁

Optional Keys§	
D Series	
Code	Description
Blank	D018 (standard key)

e

Cam Option	
Code	Description
KF4	F cam (standard)
KG4	G cam
KK4	K cam
KM4	M cam
KP4	P cam
KH4	Overlapping cam

f

Contact Block Option	
Code	Description
Blank	No contacts
AAXX	Two contact targets for a given cam as shown in the W (white side) column of Table 1 and 2 contact targets for the same cam as shown in the B (black side) column of Table 1. (One Cat. No. 800T-XA contact block per side. Two contact blocks total)

f (cont'd)

Contact Block Option	
Code	Description
AAAA	Four contact targets for a given cam as shown in the W (white side) column of Table 1 and 4 contact targets for the same cam as shown in the B (black side) column of Table 1. (Two Cat. No. 800T-XA contact blocks per side. Four contact blocks total.)
PenTUFF (Low Voltage)	
Code	Description
FFXX	Two contact targets for a given cam as shown in the W (white side) column of Table 1 and 2 contact targets for the same cam as shown in the B (black side) column of Table 1. (One Cat. No. 800T-XAV contact block per side. Two contact blocks total)
FFFF	Four contact targets for a given cam as shown in the W (white side) column of Table 1 and 4 contact targets for the same cam as shown in the B (black side) column of Table 1. (Two Cat. No. 800T-XAV contact blocks per side. Four contact blocks total.)

Table 1. Selector Switch Cam Targets

Contact Block Suffix Code	Contact Block Side	Circuits	Cam Description																								
			KF4		KG4		KK4*		KM4*		KP4		KN4‡														
			↻	↻	↻	↻	↻	↻	↻	↻	↻	↻	↻	↻	↻	↻	↻										
↑ AAAA FFFF ↓	↑ AAXX FFXX ↓	White	A	X	O	O	O	X	X	O	O	O	O	X	X	X	O	O	O	O	O	X	O	X	O	O	
			B	O	X	O	O	O	O	X	O	X	X	O	O	O	X	X	O	O	X	O	O	O	O	O	O
	Black	A	O	O	X	X	O	O	O	O	X	O	X	O	O	X	O	O	X	O	X	O	X	O	X	O	O
		B	O	O	X	O	O	O	O	X	O	X	X	O	O	X	O	O	X	O	O	X	O	O	X	O	O
	White	A	X	O	O	O	X	X	O	O	O	O	X	X	X	O	O	O	O	O	O	X	O	X	O	O	O
		B	O	X	O	O	O	O	X	O	X	X	O	O	O	X	X	O	O	X	O	O	O	O	O	O	X
	Black	A	O	O	O	X	X	O	O	O	X	O	O	X	O	O	O	X	O	O	X	X	O	O	X	O	O
		B	O	O	X	O	O	O	O	X	O	X	X	O	O	X	O	O	X	O	O	O	X	O	O	O	O

Note: W = White B = Black. X = Closed/O = Open. For additional targets and overlapping cams, see Publication 800T-2.8.

* Each standard and knob lever operator is factory assembled with a white insert. Other colors available, factory assembled, if ordered in quantities of 10 or more.

* One insert of each color (blue, green, orange, red, and yellow).

‡ Overlapping cam.

§ Devices supplied with 2 keys. Replacement part number for standard D018 key is X-181170

♣ Not available with wing lever operator.

Pilot Light Units



Transformer Type Pilot Light
 Cat. No. **800H-PP16M**



Push-to-Test Pilot Light
 Cat. No. **800H-PPT16M**



Pigtail Pilot Light
 Cat. No. **800H-LP24M**

Type	Lamp Type	Supply Voltage	Lens Color*	Pilot Light	Push-to-Test	Pigtail
				Cat. No.*	Cat. No.*‡	Cat. No.*§
Operator only*				800H-QPN00	800H-QPB00XX	—
Full voltage	Incandescent	24V AC/DC	Multi-color kit	800H-QP24M	800H-QPT24M	800H-LP24M
		120V AC/DC		800H-QP10M	800H-QPT10M	800H-LP10M
	No lamp	No lens	800H-QPN25	800H-QPTN25	800H-LPN25	
	LED	24V AC/DC	Multi-color kit	—	—	800H-LPH24M
120V AC				—	—	800H-LPH10M
Universal	LED	12...130V AC/DC	Multi-color kit	800H-QPH2M	800H-QPTH2M	—
Transformer	Incandescent	120V AC, 50/60 Hz	Multi-color kit	800H-PP16M	800H-PPT16M	—
	LED			800H-PPH16M	800H-PPTH16M	—

- * Units ship with multi-color insert packet including amber, blue, green, red, and white.
- * For long barrel versions, add an **L** to the cat. no. **Example:** Cat. No. 800HL-QPH2M
- ‡ Includes one standard Cat. No. 800T-XA (1 N.O./1 N.C.) contact block.
- § Pigtail length is 7 in.
- * Operator only supplied without power module, lamp, lens cap, or contact blocks.

Typical Pilot Light Wiring Diagrams

See applicable Codes and Laws.

Push-to-Test Pilot Light Device Schematic

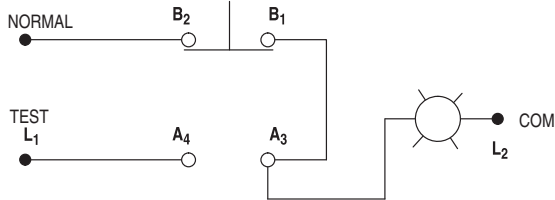

Dual Input Diode Pilot Device Schematic

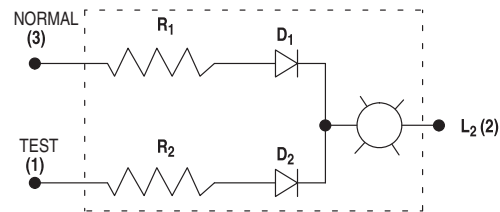

Dual Input Pilot Light Typical Application Wiring Diagram

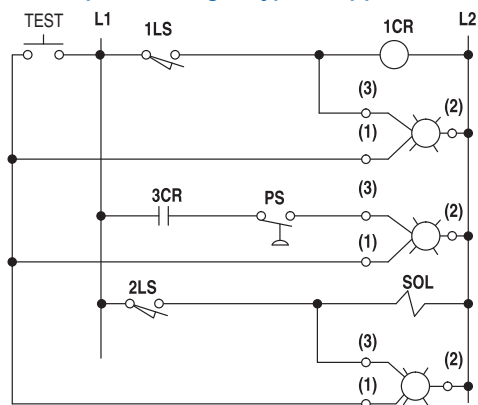

Dual Input Pilot Light Transformer Type Device Schematic

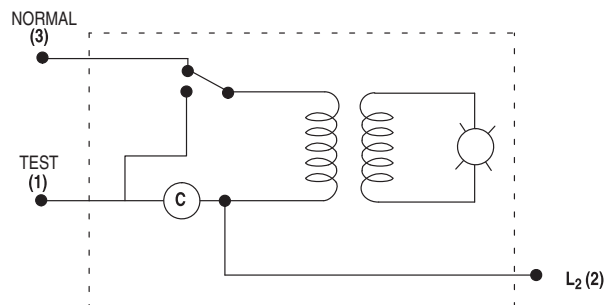

Hazardous Location Push Buttons

Product Selection

Pilot Light Units

800 H - PP T d 16 M
 a b c d e f

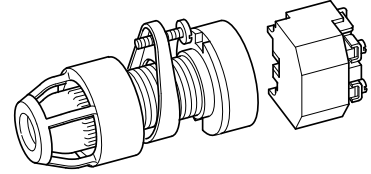

a

Barrel Type	
Code	Description
H	Standard barrel length
HL	Long barrel

b

Power Module Type	
Code	Description
PP	Transformer (or dual input)
QP	Full voltage/Universal
LP	Pigtail — full voltage*
LPK	Pigtail — full voltage* (for dual push buttons)

c

Lamp Test Options	
Code	Description
Blank	No test option
T	Push-to-test
D	Dual input — diode‡
DT	Dual input — transformer relay‡

d

Illumination Option	
Code	Description
Blank	Incandescent
H	LED♣

e

Voltage	
Transformer	
Code	Description
16	120V AC, 50/60 Hz
26	240V AC, 50/60 Hz
46	480V AC, 50/60 Hz
56	600V AC, 50/60 Hz
Full Voltage — Incandescent	
Code	Description
24	24V AC/DC
10	120V AC/DC
20	240V AC/DC
Universal — LED	
Code	Description
2	12...130V AC/DC
Dual Input	
Code	Description
16	120V AC
24	24V AC/DC‡
Pigtail	
Code	Description
24	24V AC/DC
10	120V AC/DC
20	240V AC/DC

f

Lens Color	
Code	Color
Blank	No lens with no contacts
M	Multi-color*

Note: Push-to-test pilot light is supplied with a factory jumpered 800T-XA, 1 N.O - 1 N.C contact block.
 * Multi-color insert packet includes amber, blue, green, red, and white
 * Lamp test options is not available with pigtail.
 ‡ Only available with power module type code **PP**.
 ♣ LED illumination option is not available with diode type dual input lamp test options.
 † Dual input diode only.

Ordering Information for Stations

Stations

Bulletin 800H Type 7 & 9 stations are available as factory assembled or as components for field assembly.

Factory-Assembled Stations

Bulletin 800H Type 7 & 9 control stations are designed to meet the requirements of the National Electrical Code. These stations are listed by Underwriters Laboratories, Inc. for Class I, Divisions 1 & 2, Groups C & D Hazardous Gases or Vapors, Class II, Divisions 1 & 2, Groups E, F & G Hazardous Dust and Class III Hazardous Fiber Locations. In addition the single gang shallow base, **Cat. No. 800H-IHZX7**, meets Class I, Group B requirements as defined in the National Electrical Code.

Factory-assembled stations may be ordered in three ways:

- **Standard**, factory-assembled stations listed on page 10-154.
- **Custom**, factory-assembled stations can be ordered by following the instructions listed on this page.

Station Design Guidelines

(Also see Applicable Codes and Standards)

1. Push-to-test pilot lights, illuminated push buttons, push-to-pull units, 4-position selector switches, and all operators with two contact blocks fastened along side one another or with a power module and contact block along side one another must be installed in a single hole cover.
2. Dual push button units may only be installed in a single-hole cover or the specially designed two-hole cover (Cat. No. 800H-NP33), which can accommodate the dual push button and the special pigtail pilot light (Cat. No. 800H-LPK10R).
3. When two components are installed in one cover, contact blocks are restricted to one side of the operator. Contact blocks of each operator must face each other.
4. One level of contact blocks is maximum in a shallow base or deep base when used with a sealing well. Contact blocks, except sealed switch type, may be mounted two deep in other bases.
5. If sealed switch contact blocks or a sealing well are used, a deep enclosure is required.
6.
 - a. START push buttons should be green or black flush, installed to the left or above STOP push buttons.
 - b. EMERGENCY STOP push buttons should be a red mushroom.
 - c. STOP push buttons should be red extended, installed to the right or below START push button.
 - d. STOP push buttons should be installed in the last position (bottom or right) of each unit when required.
 - e. Pilot lights should be installed in the first position (top or left side) of each unit when required.

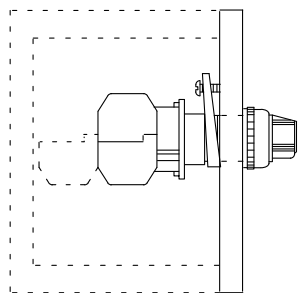

Design Guideline #1

Push-to-test pilot lights, illuminated push buttons, push-pull units, 4-position selector switches, all operators with two contact blocks fastened along side one another or with a power module and contact block along side one another must be installed in a single hole cover.

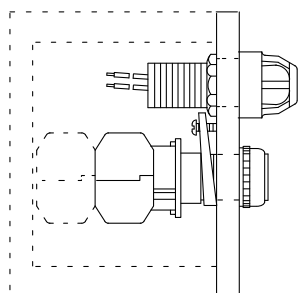

Design Guideline #2

Dual push button units may only be installed in a single hole cover or the specially designed two hole cover (Cat. No. 800H-NP33), which can accommodate the dual push button and the special pigtail pilot light (Cat. No. 800H-LPK10R).

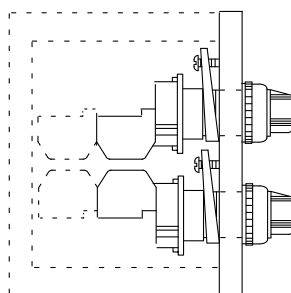

Design Guideline #3

When two components are installed in one cover, contact blocks are restricted to one side of the operator. Contact blocks of each operator must face each other.

Design Guideline #4

One level of contact blocks is maximum in a shallow base or deep base when used with a sealing well. Contact blocks, except sealed switch type, may be mounted two deep in other bases.

Components for Field Assembled Stations

Eight-gang maximum*. These 2- and 3-gang modules may be assembled into the multi-gang stations by installing a coupler kit between the enclosures. These separate bases, covers, or bases with covers are Underwriters Laboratories, Inc. listed when properly assembled. These enclosures meet the requirements of Class I, Division 1 & 2, Groups C & D, Class II, Divisions 1 & 2, Groups E, F & G, and Class III hazardous locations as defined in the National Electrical Code. Bulletin 800H Type 7 & 9 components are designed for these modular enclosures and are UL Listed for this purpose.

Note: Components may be assembled as multi-gang units up to an **eight-gang maximum***.

To select components for field assembly, follow the instructions for ordering a custom-built station.

Instructions for Ordering Custom-Built Stations

1. Select operators required from page 10-154. (If lever type, select covers from page 10-172 and go to Step 3).
2. Select covers based on mounting requirements on page 10-172.
3. Select an assembled base from page 10-173 in accordance with the number of covers selected in Step 2.
4. Select legend plates from page 10-181...10-182 (and accessories, if required, from pages page 10-175...10-179).
5. If a particular sequence of operators or mounting orientation (vertical versus horizontal) is required, include a rough sketch.

* Flange width is designed to comply with Underwriters Laboratories standards to enclosures with an internal free volume of up to 300 cubic inches (a maximum 8-gang assembly).

Hazardous Location Push Buttons

Product Selection

Covers, Lever Type Actuator

Note: Lever type covers are furnished without contact blocks. Legend plate for half lever is **STOP**; full lever momentary and maintained is a **START-STOP**. To order without legend plate, add suffix **X** to the cat. no.

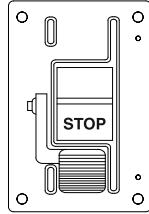

Half Lever

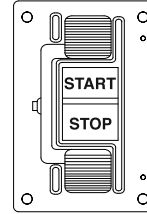

Double Lever Momentary

Half Lever	Double Lever Momentary	Double Lever Maintained	Double Lever Momentary/Maintained*
Cat. No.	Cat. No.	Cat. No.	Cat. No.
800H-NP14	800H-NP15	800H-NP16	800H-NP34

* A normally open circuit configuration is recommended for use behind this momentary lever and a late break normally closed circuit configuration is required for use behind the maintained lever to achieve proper functioning of the device.

Covers, Component Type Button

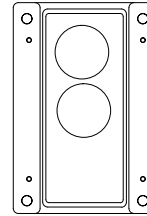
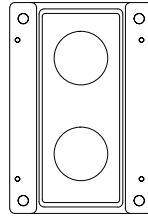
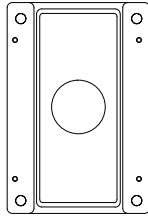
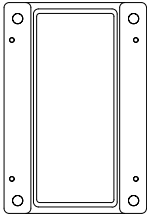

Blank	One Hole*	Two Hole†	Two Hole Special§
Cat. No.	Cat. No.	Cat. No.	Cat. No.
800H-NP32	800H-NP30	800H-NP31	800H-NP33

* One-hole covers use a jumbo legend plate only.

† Two-hole covers use a standard legend plate only.

§ This special two-hole cover can accommodate the pigtail pilot light (**Bulletin 800H-LPK10** series), the dual push button or any non-illuminated unit. Legend plates (**Cat. No. 800H-Y140J** green and red split-field) and (**Cat. No. 800H-Y141J** grey full field), are the only legend plates suitable for use with this cover.

Hazardous Location Push Buttons

Product Selection

Assembled Bases (for Field Assembly and Custom Stations)

Enclosure Covers — See enclosure cover tables for a complete listing of covers for these bases.

Special Conduit Entries — For conduit entries not listed, consult your local Rockwell Automation sales office or Allen-Bradley distributor.

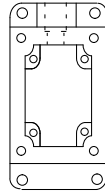

1-Gang Shallow*

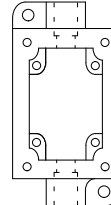

1-Gang Deep*

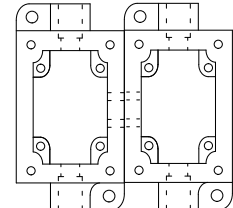

2-Gang Horizontal*

Conduit Entry	Cat. No.	Cat. No.	Cat. No.
3/4 in. Dead End	800H-1HZX7	800H-1HVX7	—
3/4 in. Feed Through	—	800H-1HVX7M1	—
1 in. Dead End	—	800H-1HVX7M2	800H-2HHX7
1 in. Feed Through	—	800H-1HVX7M3	—

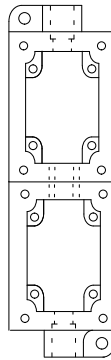

2-Gang Vertical*

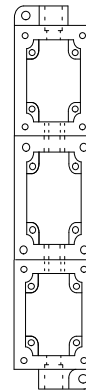

3-Gang Vertical*

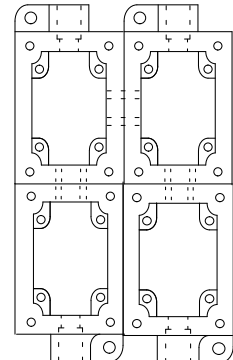

4-Gang*

Conduit Entry	Cat. No.	Cat. No.	Cat. No.
1 in. Feed Through	800H-2HYX7	800H-3HYX7	800H-4HVX7

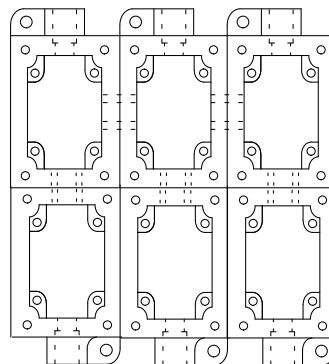

6-Gang*

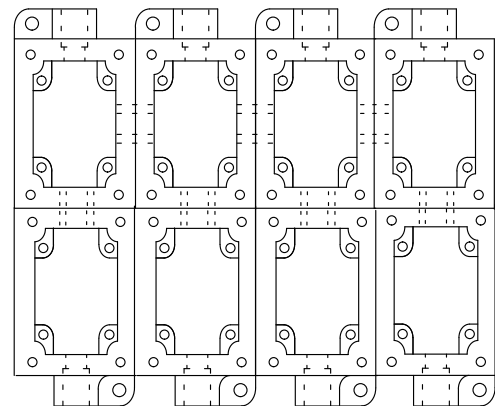

8-Gang*

Conduit Entry	Cat. No.	Cat. No.
1 in. Feed Through	800H-6HVX7	800H-8HVX7

* Shallow base cannot accommodate sealing well, sealed switched contact blocks, or stacked contact blocks. Shallow base rated for Group B.

* Deep base can accommodate sealing well, sealed switch contact blocks, or up to 2 deep standard contact blocks.

Hazardous Location Push Buttons

Product Selection

Bases for Multi-Gang Stations

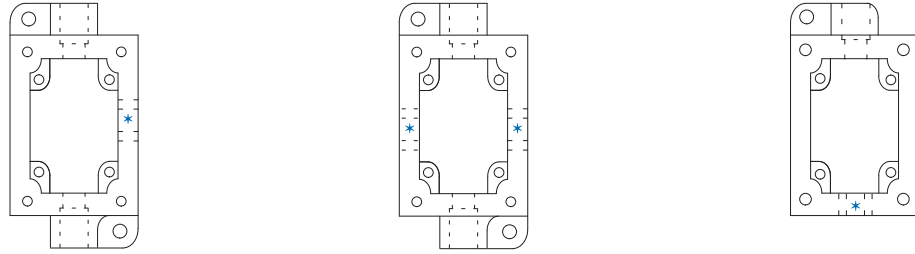

Conduit Sizes	Cat. No.	Cat. No.	Cat. No.
3/4 in. Feed Through	800H-NP40C	800H-NP41C	—
1 in. Feed Through	800H-NP40D	800H-NP41D	—
3/4 in. Dead End	—	—	800H-NP42A
1 in. Dead End	—	—	800H-NP42B

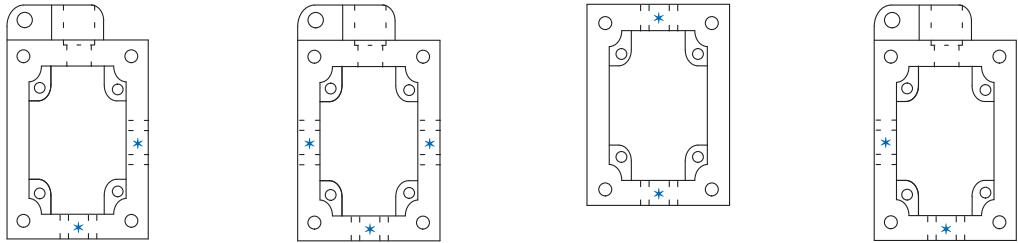

Conduit Sizes	Cat. No.	Cat. No.	Cat. No.	Cat. No.
3/4 in. Dead End	800H-NP43A	800H-NP44A	—	800H-NP46A
1 in. Dead End	800H-NP43B	800H-NP44B	—	800H-NP46B
None	—	—	800H-NP45	—

Example:

7-gang base with 1 in. through-feed conduit consists of:

- 3-Cat. No. **800H-NP42B**
- 1-Cat. No. **800H-NP43B**
- 1-Cat. No. **800H-NP44B**
- 1-Cat. No. **800H-NP45**
- 1-Cat. No. **800H-NP46B**
- 6-Cat. No. **800H-NP7**

Plus up to four 1 in. plugs (Cat. No. **800H-NP11**) to close unused conduit openings.

Caution: Do not assemble more than eight enclosure gangs together, to avoid exceeding the internal volume for which the flame path of these enclosures is designed.

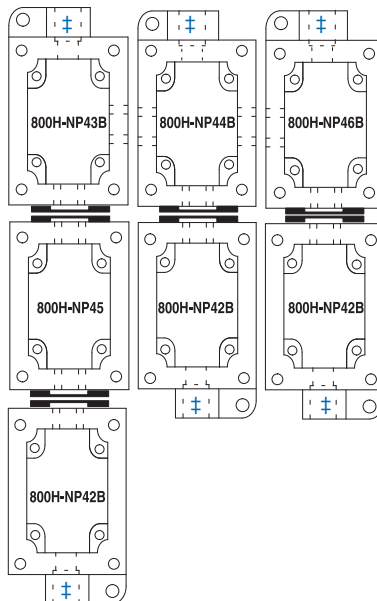

* When coupling modular enclosures together, a coupler kit (Cat. No. **800H-NP7**) is required between enclosures.
 † 1 in. conduit through-feed (all gangs).

Modifications and Accessories

Contact Blocks*

Packaged in kit form for field installation. All necessary mounting hardware is provided with each contact block kit. Contact ratings are listed on page 10-153.

Note: It is not recommended to mount more than four contact blocks on any one unit (maximum two blocks deep). Sealed switch contact blocks are limited to two blocks per unit maximum.

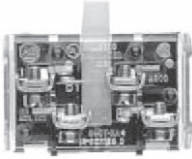

Shallow Block

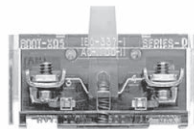

Mini Block

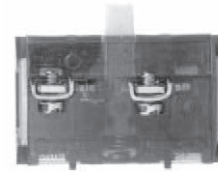

PentUFF (Low Voltage) Contact Block

Contact Type	Shallow Block**‡	Mini Block*‡	PentUFF (Low Voltage) Block**‡
	Cat. No.	Cat. No.	Cat. No.
1 N.O.	800T-XD1	800T-XD5	800T-XD1V
1 N.C.	800T-XD2	800T-XD6	800T-XD2V
1 N.O.E.M.	800T-XD3	—	800T-XD3V
1 N.C.L.B.	800T-XD4	—	800T-XD4V
1 N.O. - N.C.	800T-XA	—	800T-XAV
2 N.O.	800T-XA2	—	—
2 N.C.	800T-XA4	—	—
1 N.C.L.B. - 1 N.O.	800T-XA1	—	—
1 N.C.L.B. - 1 N.C.	800T-XA7	—	—

* To determine if a conduit seal-off is necessary, see page 10-179 for sealing well information.

** Specify Bulletin 800TC for finger-safe contact blocks. Example: **Cat. No. 800TC-XA**.

‡ Contact blocks with normally closed contacts meet direct drive positive opening standard requirements.



Logic Reed Block



Sealed Switch Block

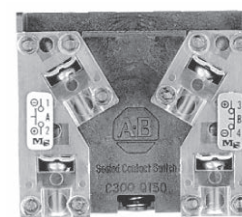

Stackable Sealed Switch Block

Contact Type	Logic Reed Block§	Sealed Switch Block§	Stackable Sealed Switch Block§
	Cat. No.	Cat. No.	Cat. No.
1 N.O.	800T-XD1R	800T-XD1P	800T-XD1Y
1 N.C.	800T-XD2R	800T-XD2P	800T-XD2Y
1 N.O. - 1 N.C.	800T-XAR	800T-XAP	800T-XAY
2 N.O.	800T-XA2R	—	800T-XA2Y
2 N.C.	800T-XA4R	—	800T-XA4Y

§ To determine if a conduit seal-off is necessary, see page 10-179 for sealing well information.

* Refer to 800T/H section, page 10-35, for additional contact blocks and accessories.

Hazardous Location Push Buttons

Accessories

Modifications and Accessories, Continued

Replacement Color Caps (Illuminated)



Pilot Light
Cat. No. 800H-N104M



Push-to-Test Pilot Light
Cat. No. 800H-N105M



Illuminated Push Button
Cat. No. 800H-N106M



Illuminated Push-Pull
Cat. No. 800H-NP50M

Color	Pilot Light	Push-to-Test Pilot Light	Illuminated Push Button	Illuminated Push-Pull
	Cat. No.	Cat. No.	Cat. No.	Cat. No.
Multi-color kit	800H-N104M	800H-N105M	800H-N106M	800H-NP50M

Replacement Color Caps (Non-Illuminated)



Momentary Mushroom — Standard (Plastic)
Cat. No. 800T-N246R



Momentary Mushroom — Jumbo (Metal)
Cat. No. 800T-N248R



Push-Pull — Standard (Metal)
Cat. No. 800H-NP51C



Push-Pull — Jumbo (Metal)
Cat. No. 800H-NP52A

Color	Momentary Mushroom — Standard (Plastic)	Momentary Mushroom — Jumbo (Metal) *	Push-Pull Standard (Metal)	Push-Pull Jumbo (Metal)
	Cat. No.	Cat. No.	Cat. No.	Cat. No.
Red	800T-N246R	800T-N248R	800H-NP51A	800H-NP52A
Green	800T-N246G	800T-N248G	800H-NP51B	800H-NP52B
Blue	800T-N246BL	800T-N248BL	800H-NP51C	800H-NP52C
Yellow	800T-N246Y	800T-N248Y	800H-NP51E	800H-NP52E
Black	800T-N246B	800T-N248B	800H-NP51H	800H-NP52H
Grey	800T-N246GR	800T-N248GR	800H-NP51G	—
Natural	—	800T-N248	—	—

* To order plastic jumbo mushroom caps, replace 248 with 247. Plastic not available in natural color.

Example: Cat. No. 800T-N248R becomes Cat. No. 800T-N247R.

Replacement Knobs and Dual Push Button Assembly



Standard Knob
Cat. No. 800H-N130F



Knob Lever
Cat. No. 800H-131F



Wing Lever
Cat. No. 800H-N138



Dual Push Button
Cat. No. 800H-NP39

Color	Standard Knob	Knob Lever	Wing Lever*	Dual Push Button
	Cat. No.	Cat. No.	Cat. No.	Cat. No.
White	800H-N130F	800H-N131F	—	—
Kit (Complete) ‡	800H-N130	800H-N131	—	—
Grey	—	—	800H-N138	—
Red	—	—	800H-N138A	—
Green Red	—	—	—	800H-NP39

* Standard finish is grey.

‡ Kit includes knob and packet of inserts (Cat. No. 800T-N123). Refer to color insert kits on page 10-179.

Modifications and Accessories, Continued

Boots—Non-Illuminated Momentary Contact Push Buttons Units

Note: For Bul. 800H/HL Type 7&9 operators, order one adapter and one boot per operator.

Adapters

Push Button Type	Cat. No.
Flush head	800H-NPAF
Extended head	800H-NPAE

Boots

Boots supplied with control stations and components are made of a chlorosulfonated polyethylene material with stainless steel insert ring. To order boots with silicone, urethane, or ethylene propylene material, see the table below. Material application information shown below.



Cat. No. 800H-N5A

Insert Material	Boot Color	Material			
		Chlorosulfonated Polyethylene ‡	Silicone • ‡	Urethane •• ‡	Ethylene • Propylene •• ‡
		Cat. No.	Cat. No.	Cat. No.	Cat. No.
Stainless steel §	Red	800H-N5A	800H-N101R	800H-N100R	800H-N103R
	Green	800H-N5B	800H-N101G	800H-N100G	800H-N103G
	Black	800H-N5H	800H-N101B	800H-N100B	800H-N103B
	Yellow	800H-N5E	800H-N101Y	800H-N100Y	—
	Blue	800H-N5C	800H-N101BL	800H-N100BL	—

* May be added to flush or extended head push button units to protect against foreign materials reaching the opening between the button and the locking ring.

§ Series B boots incorporate a stainless steel insert as standard.

‡ Dots printed on the inside of the boot identify the boot material.

Booted Knobs



Booted Standard Knob Selector Switch
Cat. No. 800H-NP5



Booted Knob Lever Selector Switch
Cat. No. 800H-NPE5

Switch Type	Boot Material*			
	Chlorosulfonated Polyethylene	Silicone •	Urethane ••	Ethylene • Propylene ••
	Cat. No.	Cat. No.	Cat. No.	Cat. No.
Standard Knob Selector Switch*	800H-NP5	800H-NP101	800H-NP100	800H-NP103
Knob Lever Selector Switch*	800H-NPE5	800H-NPE101	800H-NPE100	800H-NPE103

* Dots printed on the inside of the boot identify the boot material.

* Includes color insert kit.

Push Button Guards and Mushroom Push Button Guards



Cat. No. 800H-NP19



Cat. No. 800H-NP13



Cat. No. 800H-NP9



Cat. No. 800H-NP12

Push Buttons, Pilot Lights and Push-to-Test	Extra Long Guard (1 in.) for Push Button	Mushroom	Jumbo Mushroom
Cat. No.	Cat. No.	Cat. No.	Cat. No.
800H-NP19	800H-NP13	800H-NP9	800H-NP12

Protective Rings



Protective Ring for 2-Position Push-Pull
Cat. No. 800H-NP40



Jumbo Protective Ring for 2-Position Push-Pull
Cat. No. 800H-NP40J



Protective Ring for Push-Pull Devices		
Description	Type	Cat. No.
Protective ring for Bul. 800H 2-position non-illuminated push-pull operators. Often used to avoid unintentional tripping of E-stop operators. Available for standard size button (40 mm) or for jumbo button (60 mm).	For standard size button	800H-NP40
	For jumbo size button	800H-NP40J

Hazardous Location Push Buttons



Accessories

General Accessories

Plugs

	Description	Cat. No.	
 Cat. No. 800H-NP7	Coupler Used for both horizontal and vertical assembly.	800H-NP7	
	Description	Type	Cat. No.
 Cat. No. 800H-NP1 (Operators not included)	Closing Plug Whenever an enclosure with more than the required number of openings is used, this plug can be used to close the unused openings. Includes synthetic O-ring washer.	For Cover Hole	800H-NP1
		For Base Coupler Hole	800H-NP3
	Description	Size	Cat. No.
 Cat. No. 800H-NP10 (Operators not included)	Conduit Entry Plug This plug can be used to plug unused conduit openings in Type 7 and 9 bases.	3/4 in.	800H-NP10
		1 in.	800H-NP11

Locking Attachments





	Description	Cat. No.
 Cat. No. 800H-NP2 (Padlock not included)	Push Button Padlocking Attachments This device permits locking in the depressed position on extended head push button units only.	800H-NP2
 Cat. No. 800H-NP17 (Padlock not included)	Dual Push Button Extended Head Padlocking Attachments This device permits locking for dual push button — extended head units only.	800H-NP17

General Accessories, Continued

Locking Attachments

	Description	Cat. No.
 <p>Cat. No. 800H-NP4 (Padlock not included)</p>	<p>Padlocking Cover Padlocking cover is used for Type 7 and 9 selector switches, non-illuminated push buttons (except mushrooms) and non-illuminated 2-position push-pull units, but not for potentiometer units. Note: Push-pull units will only lock in the depressed position. Padlocking cover includes blank legend plate for customer marking. A pre-marked legend plate entitled OPEN COVER TO OPERATE (front view) and PULL-TO-START-PUSH-TO-STOP (rear view) is available. To order legend plate only, specify Cat. No. 800H-W174L.</p>	800H-NP4

Miscellaneous



	Description	Style	No. of Wires	Cat. No.		
 <p>Cat. No. 800H-NPRD91</p>  <p>Cat. No. 800H-NPD93</p>	<p>Sealing Well with or without Integral Type 3 Flange Seal These sealing wells can only be used with bases having 1 in. conduit entries. They reduce costs usually necessary with other conduit seal fittings for most installations (subject to applicable codes and laws) while maintaining Type 7 and 9 integrity. When using a sealing well with integral flange seal for Type 3 outdoor applications, an approved drain fitting must be provided. (Refer to National Electrical Code.)</p>	With Integral Flange Seal, Type 3, 7, and 9	2	800H-NPRD90		
			4	800H-NPRD91		
			6	800H-NPRD92		
			8	800H-NPRD93		
				Without Integral Flange Seal, Type 7 and 9	2	800H-NPD90
					4	800H-NPD91
					6	800H-NPD92
					8	800H-NPD93
 <p>Cat. No. 800H-NP20</p>	<p>Type 3 Flange Seal This seal provides a Type 3 rating while maintaining Type 7 and 9 integrity. An approved drain (see listing) is required for condensation when using this option (refer to National Electrical Code). For a Type 4 rating, use sealing nuts to seal the push button operators in addition to using the flange seal. Sealing kit is comprised of flange seal and sealing nut. They are used with the Allen-Bradley enclosures listed on page 10-154 for outdoor applications.</p>	Flange Seal		800H-NP20		
		Drain for 3/4 in. Conduit Opening		800H-NP21		
		Drain for 1 in. Conduit Opening		800H-NP22		
		Type 4 Sealing Nut		800H-N479		
 <p>Cat. No. 800H-NP21</p>		Type 4 Sealing Kit		800H-N479F		
 <p>Cat. No. 800H-NP23R</p>	<p>Color Insert Kit These color insert kits are used with illuminated push buttons, pilot lights, push-pull, and push-to-test push buttons (order quantity of 1 to receive kit of 5 inserts).</p>	Color		Cat. No.		
		Red		800H-NP23R		
		Green		800H-NP23G		
		Amber		800H-NP23A		
		Blue		800H-NP23B		
		White		800H-NP23W		
One of each color		800H-NP23				

Hazardous Location Push Buttons

Accessories

Replacement Lamps

Pilot Lights, Illuminated Push Buttons, Illuminated Push-Pull, Illuminated Push-Pull/Twist to Release, and Illuminated Selector Switches

Lamp	Type	Current, Typical	Lamp Voltage	ANSI No.	Catalog Voltage Code	Cat. No.
	Full Voltage Transformer	150 mA/250 mA	6.3V AC	755/1866	6, 16, 26, 36, 46, 56, 76	* 800T-N65
	Full Voltage	80 mA	14V AC/DC	756	12	* 800T-N141
		70 mA	24V AC/DC	757	24	* 800T-N157
		50 mA	48V AC/DC	1835	48	* 800T-N365
	Full Voltage Resistor	22 mA	120V AC/DC	949	10, 11	* 800T-N169
	Flashing	150 mA	6V AC/DC	267	6	* 800T-N212
	Dual Input Diode	57 mA	24V AC/DC	24 MB	24	* 800T-N180
21 mA		120V AC	90 MB	16	* 800T-N261	
Neon 	—	2 mA	120V AC/DC	B2A	10, 20	609-N9
Lamp	Type	Current, Typical*	Lamp Voltage	Leakage Current	Code	Cat. No.*
	Universal	13 mA @ 24V DC 8.5 mA @ 120V AC†	3V‡	3 mA	2	800T-N376x
	Transformer	60	6V	14 mA	16, 26, 46, 56	800T-N377x

* Item is sold in multiples of 5. Order quantity of 5 to receive package of 5 pieces.

* To complete the cat. no. replace the **x** with the first letter of the desired color: **Green**, **Red**, or **White**.

† Typical current consumption values indicated are relative to the input of the power module.

‡ Lamp is intended for use with power module Cat. No. 800TC-N374 which has an input voltage rating of 12 ...130V AC/DC.

Legacy LED Lamps*

Lamp	Type	Current, Typical>	Lamp Voltage	Leakage Current	Catalog Voltage Code	Cat. No.‡
	Full Voltage	13 mA/22 mA	12V AC/DC	3 mA	12	800T-N362x
		20 mA/21 mA	24V AC/DC	3 mA	24	800T-N319x
		12 mA/17 mA	32V AC/DC	3 mA	32	800T-N363x
		9 mA/14 mA	48V AC/DC	3 mA	48	800T-N364x
		3.3 mA/6 mA	120V AC	—	10	800T-N320x
		4.5 mA/6.2 mA	130V AC/DC	3 mA	13	800T-N321x
	Full voltage	50 mA	6V AC	14 mA	6, 16, 26, 36, 46, 56, 76	800T-N318x
Flashing	18 mA	24V AC/DC	—	N/A	† 800T-N319Fx	

* In full voltage applications, these lamps are intended to be used with power module Cat. No. 800T-N330.

‡ All LEDs except 120V have an internal shunt resistor for use with solid-state outputs. LEDs will not illuminate below listed leakage current.

> Typical current draw varies with LED color. The first mA value is for a green or blue LED and the second mA value is for a red or amber LED.

‡ To complete the cat. no. replace the **x** with the first letter of the desired color: **Amber**, **Green**, **Red**, **Blue**, or **White**. White LEDs only available in 6V, 24V, 120V, and 130V.

† Flashing rate is 2 Hz.

Legend Plates

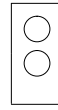
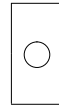
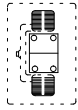

Blank Legend Plates

	Lever Style	Standard Size	Jumbo Size	Special Jumbo Size
	Use 1 lever style legend with each lever type cover (Cat. Nos. 800H-NP14, -NP15, -NP16 or -NP34)	Use 2 standard size legends with each standard 2 hole cover (Cat. No. 800H-NP31)	Use 1 jumbo size legend with each standard 1 hole cover (Cat. No. 800H-NP30)	Use 1 special jumbo legend with each special 2 hole cover (Cat. No. 800H-NP33) Ex: Dual Push Button/ Pigtail Pilot Light
Legend Plate Color	Cat. No.	Cat. No.	Cat. No.	Cat. No.
Grey	—	800H-Y59	800H-Y59J	800H-Y141J
Red	—	800H-Y121	800H-Y121J	—
Green	—	800H-Y136	800H-Y136J	—
Yellow	—	800H-Y700	800H-Y700J	—
Top Grey — Bottom Grey	800H-Y222	—	—	—
Top Grey — Bottom Red	800H-Y223	—	—	—
Left Green — Right Red	—	—	—	800H-Y140J
Grey with Potentiometer Graduations	—	800H-Y109	800H-Y109J	—

Custom Legend Plates

	Lever Style	Standard Size	Jumbo Size	Special Jumbo Size
	Use 1 lever style legend with each lever type cover (Cat. Nos. 800H-NP14, -NP15, -NP16 or -NP34)	Use 2 standard size legends with each standard 2 hole cover (Cat. No. 800H-NP31)	Use 1 jumbo size legend with each standard 1 hole cover (Cat. No. 800H-NP30)	Use 1 special jumbo legend with each special 2 hole cover (Cat. No. 800H-NP33) Ex: Dual Push Button/ Pigtail Pilot Light
Legend Plate Color	Cat. No.	Cat. No.	Cat. No.	Cat. No.
Grey	—	* 800H-Y59E	* 800H-Y59JE	* 800H-Y141JE
Red	—	* 800H-Y121E	* 800H-Y121JE	—
Green	—	* 800H-Y136E	* 800H-Y136JE	—
Yellow	—	800H-Y700E	800H-Y700JE	—
Top Grey — Bottom Grey	* 800H-Y222E	—	—	—
Top Grey — Bottom Red	* 800H-Y223E	—	—	—
Left Green — Right Red	—	—	—	* 800H-Y140JE
Grey with Potentiometer Graduations	—	* 800H-Y109E	* 800H-Y109JE	—

* Horizontally mounted engraved legend plates (with standard or custom marking) are available. Add the letter **H** after the **Y** in the cat. no.
 Example: Cat. No. **800H-Y222E** becomes **800H-YH222E**.

Lever Style Legend Plates with Standard Markings

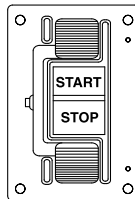

Legend Marking	Cat. No.	Legend Marking	Cat. No.
Upper/Lower		Upper/Lower	
HAND AUTO	800H-Y228	OPEN CLOSE	800H-Y205
JOG RUN	800H-Y227	RUN STOP (Red)	800H-Y226
JOG STOP (Red)	800H-Y206	START STOP (Red)	800H-Y200
ON OFF	800H-Y225	—	—

Hazardous Location Push Buttons

Accessories

Legend Plates, Continued

Legend Plates with Standard Markings

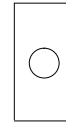

Legend Marking	Standard Size	Jumbo Size	Legend Marking	Standard Size	Jumbo Size
	Cat. No.	Cat. No.		Cat. No.	Cat. No.
AUTO-OFF-HAND	800H-Y1	800H-Y1J	ON	800H-Y30	800H-Y30J
AUTO-MAN-HAND	800H-Y125	800H-Y125J	OPEN	800H-Y31	800H-Y31J
CLOSE	800H-Y2	800H-Y2J	OPEN-CLOSE	800H-Y32	800H-Y32J
CYCLE START	800H-Y62	800H-Y62J	OPEN-OFF-CLOSE	800H-Y33	800H-Y33J
DOWN	800H-Y3	800H-Y3J	OUT	800H-Y34	—
EMERG. STOP (Red)	800H-Y4	800H-Y4J	PUSH TO STOP-PULL TO START	800H-Y118	800H-Y118J
FAST	800H-Y5	800H-Y5J	POWER ON	800H-Y139	800H-Y139J
FEED START	800H-Y66	800H-Y66J	RAISE	800H-Y35	800H-Y35J
FEED STOP	800H-Y67	800H-Y67J	RAISE-LOWER	800H-Y36	800H-Y36J
FOR.-REV.	800H-Y6	800H-Y6J	RAISE-OFF-LOWER	800H-Y37	800H-Y37J
FOR.-OFF-REV.	800H-Y7	800H-Y7J	RESET	800H-Y38	800H-Y38J
FORWARD	800H-Y8	800H-Y8J	REVERSE	800H-Y39	800H-Y39J
FOURTH SPEED	800H-Y124	800H-Y124J	RUN	800H-Y40	800H-Y40J
FULL SPEED	800H-Y9	800H-Y9J	RUN-INCH	800H-Y134	800H-Y134J
HAND-AUTO	800H-Y10	800H-Y10J	RUN-JOG	800H-Y41	800H-Y41J
HAND-OFF-AUTO	800H-Y11	800H-Y11J	SAFE-RUN	800H-Y42	800H-Y42J
HIGH	800H-Y12	800H-Y12J	SECOND SPEED	800H-Y43	800H-Y43J
HIGH-LOW	800H-Y13	800H-Y13J	SLOW	800H-Y44	800H-Y44J
HIGH-OFF-LOW	800H-Y14	800H-Y14J	SLOW-FAST	800H-Y45	800H-Y45J
IN	800H-Y15	800H-Y15J	SLOW-OFF-FAST	800H-Y46	800H-Y46J
INCH	800H-Y16	800H-Y16J	SPEED*	800H-Y108	800H-Y108J
JOG	800H-Y17	800H-Y17J	START (Green)	800H-Y47	800H-Y47J
JOG FORWARD	800H-Y18	800H-Y18J	START-JOG	800H-Y48	800H-Y48J
JOG REVERSE	800H-Y19	800H-Y19J	START-STOP	800H-Y49	800H-Y49J
JOG-RUN	800H-Y20	800H-Y20J	STOP (Red)	800H-Y50	800H-Y50J
JOG-SAFE-RUN	800H-Y22	800H-Y22J	STOP-START	800H-Y51	800H-Y51J
JOG-STOP-RUN	800H-Y21	800H-Y21J	SUMMER-OFF-WINTER	800H-Y53	800H-Y53J
LEFT-RIGHT	800H-Y23	800H-Y23J	SUMMER-WINTER	800H-Y52	800H-Y52J
LOW	800H-Y24	800H-Y24J	TEST	800H-Y54	800H-Y54J
LOW SPEED	800H-Y25	—	THIRD SPEED	800H-Y55	—
LOWER	800H-Y26	800H-Y26J	UP	800H-Y56	800H-Y56J
OFF	800H-Y27	800H-Y27J	UP-DOWN	800H-Y57	800H-Y57J
OFF-COOLANT-ON	800H-Y28	800H-Y28J	UP-OFF-DOWN	800H-Y58	800H-Y58J
OFF-ON	800H-Y29	800H-Y29J	—	—	—

* Graduated potentiometer type.

Approximate Dimensions and Shipping Weights

Dimensions in inches (millimeters). Dimensions are not intended to be used for manufacturing purposes.

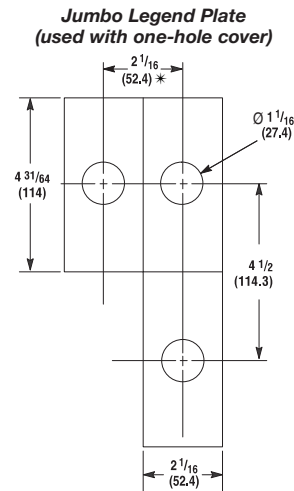
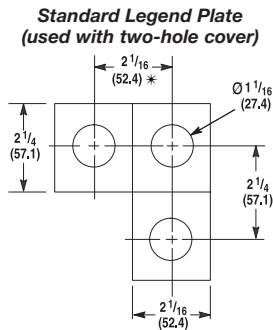

Note: Mounting hole requirements for components — 3/4 in. - 14 NPSM.*

* External thread major diameter: 1.034 in. max., 1.024 in. min.

Internal thread minor diameter: 0.958 in. min., 0.970 in. max.

† Sketch illustrates the minimum distance between center lines when mounting Bulletin 800H units with legend plates either side by side or one above the other in non Allen-Bradley enclosures. **Minimum spacing without legend plate:** When units are mounted so that the contact block terminals face each other, the 2-1/4 in. (57.2 mm) dimension must be used in order to get proper electrical clearance. When control units are mounted so that the contact block terminals do not face each other, the 1-27/32 in. (46.8 mm) dimension can be used.

Panel Thickness Requirements

Standard Barrel
[devices will fit panels up to 1 in. (25.4 mm)]

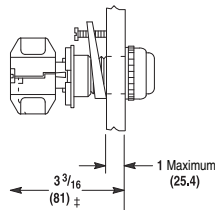

Long Barrel
[devices will fit panels up to 2-1/2 in. (63.5 mm)]

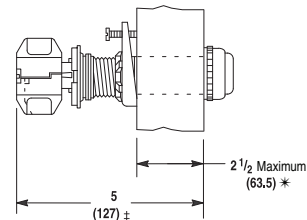

‡ When mounting in a panel thicker than 2-1/8 in. (54 mm) locking bracket not required.

† This dimension for push buttons only.

Push Buttons

Dual Head

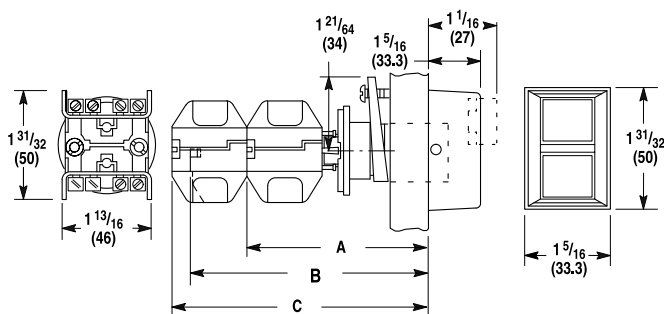

Dim.	A	B	C	Ship. Wt. [oz (kg)]
Standard Barrel	3-5/16 (84.1)	4-3/16 (106.4)	4-7/16 (112.7)	10-3/8 (0.30)
Long Barrel	4-19/32 (116.7)	5-15/32 (138.9)	5-23/32 (145.2)	13 (0.37)

Hazardous Location Push Buttons

Approximate Dimensions

Approximate Dimensions and Shipping Weights, Continued

Dimensions in inches (millimeters). Dimensions are not intended to be used for manufacturing purposes.

Push Buttons

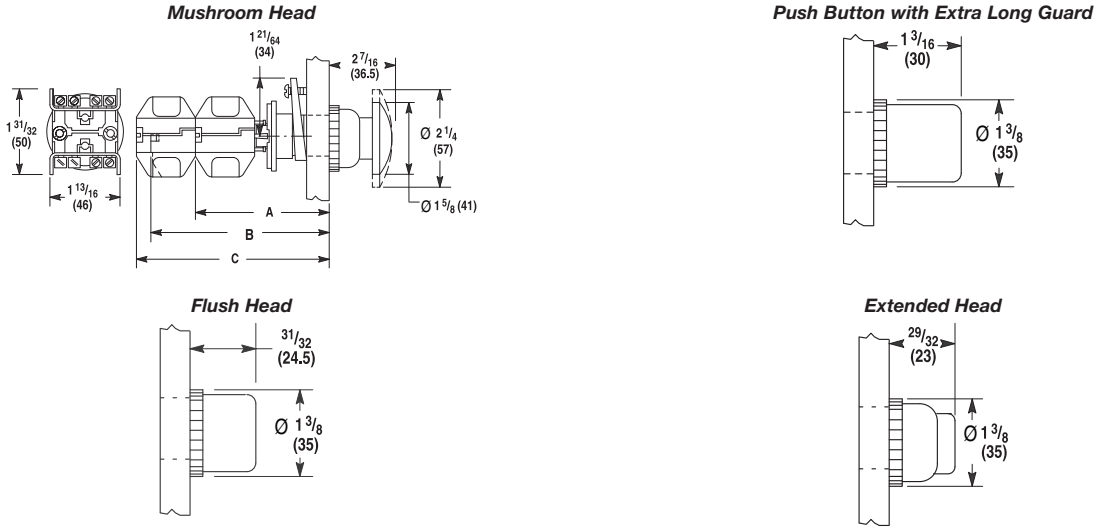

Type	Standard Barrel				Long Barrel			
	A *	B	C	Ship. Wt. [oz (kg)]	A *	B	C	Ship. Wt. [oz (kg)]
Mushroom, Flush and Extended Head	3-3/16 (81)	4-1/8 (105)	4-3/8 (111)	9-7/8 (0.28)	5 (127)	5-7/8 (149.2)	6-1/8 (155.6)	13-5/16 (0.38)
Extra Long Guard	3-3/16 (81)	4-1/8 (105)	4-3/8 (111)	10-7/8 (0.31)	5 (127)	5-7/8 (149.2)	6-1/8 (155.6)	14-5/16 (0.40)

* When using sealed switch contact block, this dimension is 4-1/16 in. (103 mm).

* When using sealed switch contact block, this dimension is 5-7/8 in. (149.2 mm).

Selector Switches

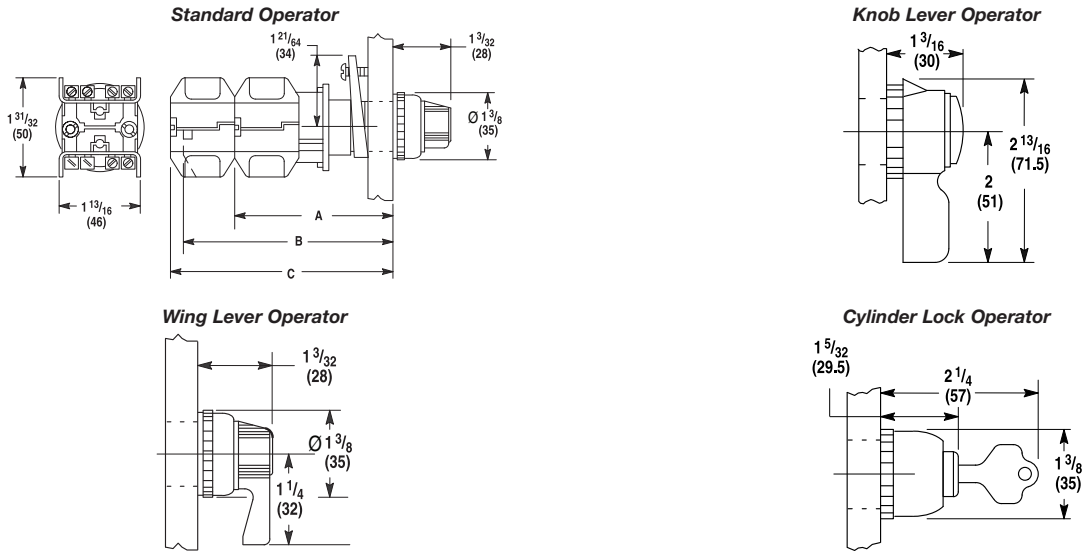

Type	Standard Barrel				Long Barrel			
	A *	B	C	Ship. Wt. [oz (kg)]	A *	B	C	Ship. Wt. [oz (kg)]
Standard and Knob Lever	3-3/16 (81)	4-1/8 (105)	4-3/8 (111)	9-1/2 (0.27)	5 (127)	5-7/8 (149.2)	6-1/8 (155.6)	14-3/8 (0.41)
Wing Lever	3-3/16 (81)	4-1/8 (105)	4-3/8 (111)	10-1/2 (0.30)	5 (127)	5-7/8 (149.2)	6-1/8 (155.6)	15 (0.42)
Cylinder Lock	3-3/16 (81)	4-1/8 (105)	4-3/8 (111)	11-1/4 (0.32)	5 (127)	5-7/8 (149.2)	6-1/8 (155.6)	16 (0.45)

* When using sealed switch contact block, this dimension is 4-1/16 in. (103 mm).

* When using sealed switch contact block, this dimension is 5-7/8 in. (149.2 mm).

Approximate Dimensions and Shipping Weights, Continued

Dimensions in inches (millimeters). Dimensions are not intended to be used for manufacturing purposes.

Illuminated Push Buttons or Push-to-Test Pilot Lights

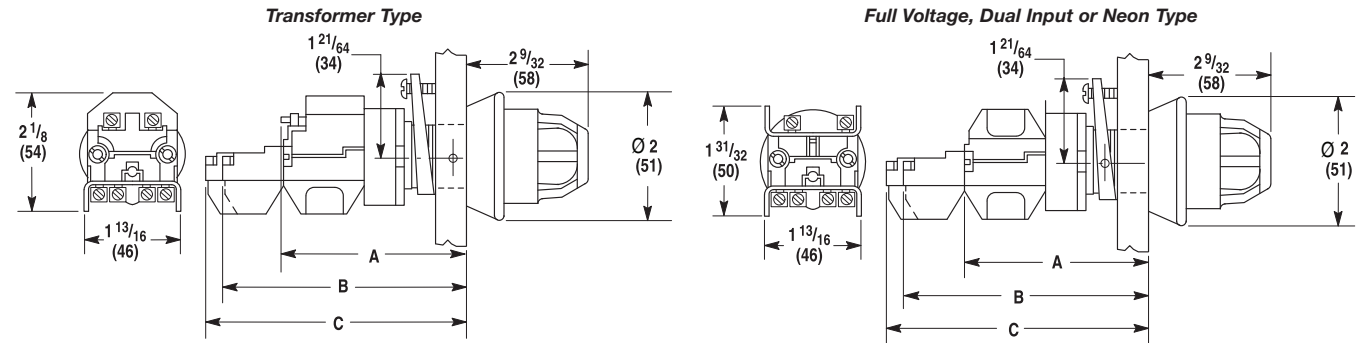

Illuminated Push Buttons, Push-to-Test Pilot Lights

Description	Style	A *	B	C	Ship. Wt. [oz (kg)]
Transformer Type	Standard Barrel	3-5/32 (80.2)	3-29/32 (99)	4-1/8 (105)	14 (0.40)
	Long Barrel	5-1/16 (128.6)	5-13/16 (147.6)	6-1/16 (154)	16-3/16 (0.45)
Full Voltage Dual Input or Neon Type	Standard Barrel	3-1/32 (77)	3-29/32 (99)	4-1/8 (105)	11-5/8 (0.33)
	Long Barrel	4-15/16 (125.4)	5-13/16 (147.6)	6-1/16 (154)	13-7/16 (0.38)

Push-Pull Units

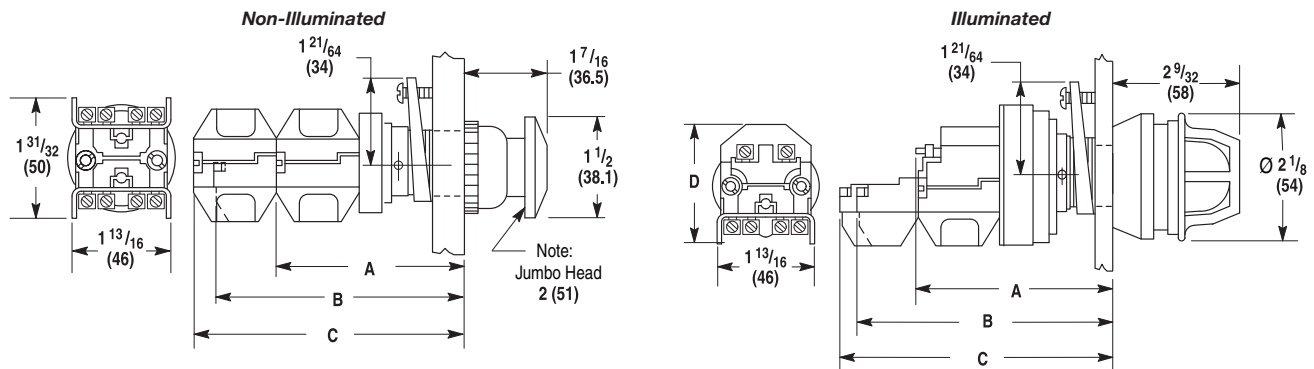

Push-Pull Units

Description	Style	A *	B	C	D	Ship. Wt. [oz (kg)]
Illuminated Transformer Type	Standard Barrel	3-9/16 (90.5)	4-9/16 (115.9)	4-5/8 (117.5)	2-1/8 (54)	15-1/2 (0.44)
	Long Barrel	4-21/32 (118.3)	5-13/32 (137)	5-21/32 (143.7)	2-1/8 (54)	17-7/16 (0.49)
Illuminated Full Voltage Type	Standard Barrel	3-7/16 (87.3)	4-9/16 (115.9)	4-5/8 (117.5)	1-31/32 (50)	12-13/16 (0.33)
	Long Barrel	4-17/32 (115.1)	5-13/32 (137)	5-21/32 (143.7)	1-31/32 (50)	14-3/4 (0.41)
Non-Illuminated Push-Pull Units	Standard Barrel	3-1/2 (88.9)	4-3/8 (111.1)	4-5/8 (117.5)	—	11-1/8 (0.32)
	Long Barrel	4-17/32 (115.1)	5-13/32 (137)	5-21/32 (143.7)	—	12-5/16 (0.34)

* When using sealed switch contact block add 7/8 in. (22.2 mm) to the listed dimension.

Hazardous Location Push Buttons

Approximate Dimensions

Approximate Dimensions and Shipping Weights, Continued

Dimensions in inches (millimeters). Dimensions are not intended to be used for manufacturing purposes.

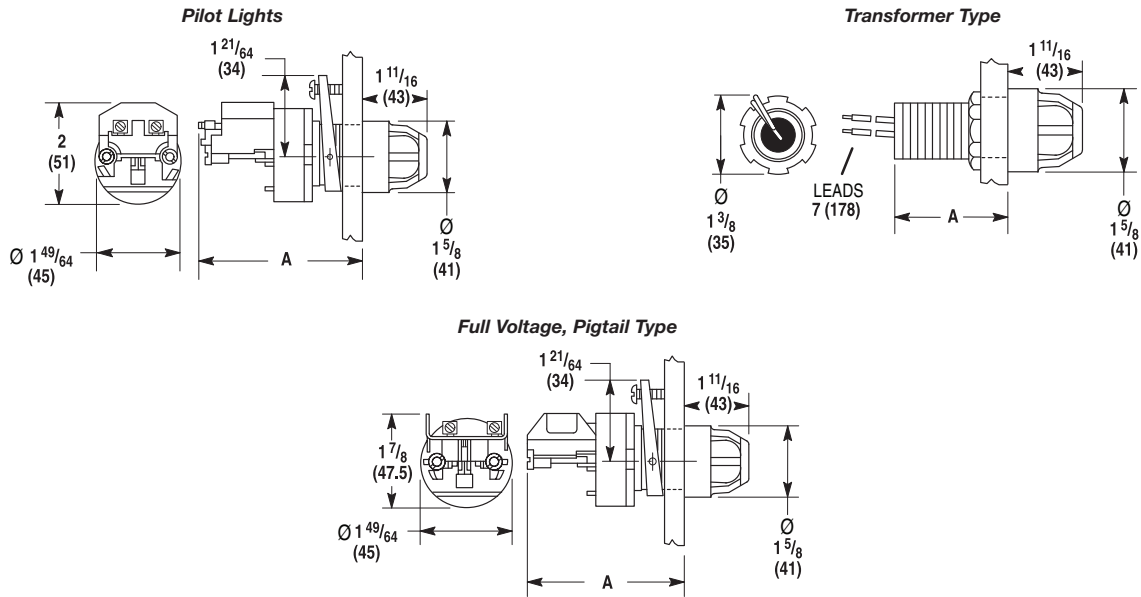

Description	Style	A	Ship. Wt. [oz (kg)]
Transformer type and dual input transformer type pilot lights	Standard Barrel	3-5/32 (80)	8-9/16 (0.24)
	Long Barrel	4-9/16 (115.9)	30-1/4 (0.85)
Full voltage, neon or dual input diode and resistor type pilot lights	Standard Barrel	3-1/32 (77)	5-13/16 (0.17)
	Long Barrel	4-7/16 (112.7)	27-1/2 (0.77)
Full voltage pigtail type pilot lights	Standard Barrel	2-3/16 (55.5)	5-5/8 (0.16)
	Long Barrel	3-43/64 (94)	8-5/16 (0.24)

Potentiometer Units

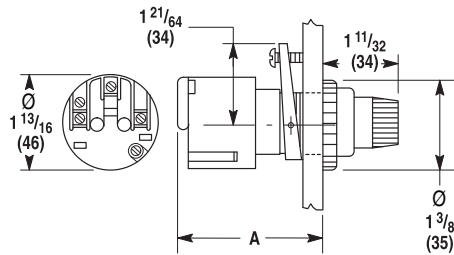

Style	A	Ship. Wt. [oz (kg)]
Standard barrel	3-1/8 (79.5)	5-3/8 (0.16)
Long barrel	4-1/2 (114.3)	8 (0.23)

Approximate Dimensions and Shipping Weights, Continued

Dimensions in inches (millimeters). Dimensions are not intended to be used for manufacturing purposes.

Shallow Base Stations

Figure 1
Shallow Base Station Lever Type

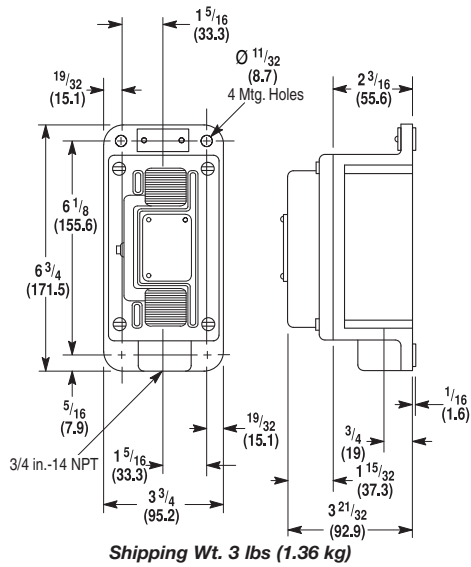
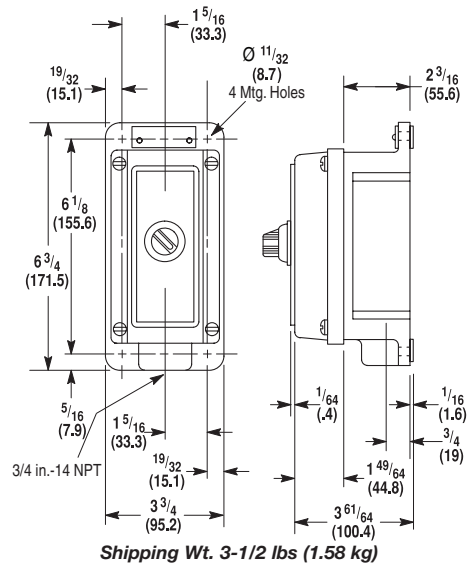

Figure 2
Shallow Base Station Component Type
1-Gang (1 or 2 devices)



Deep Base Stations

Figure 3
Deep Base Station Lever Type
1-Gang

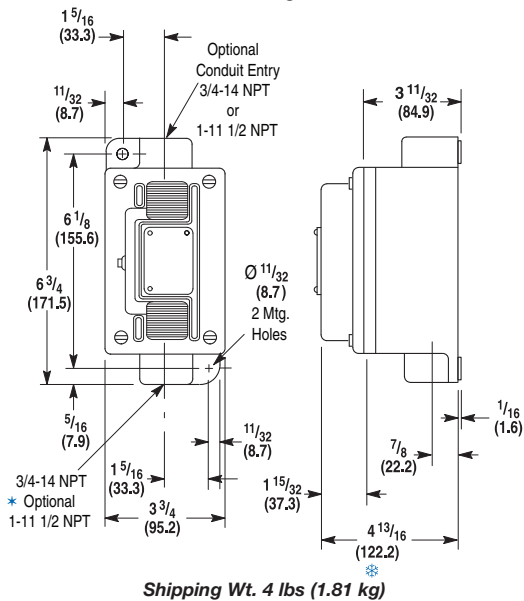
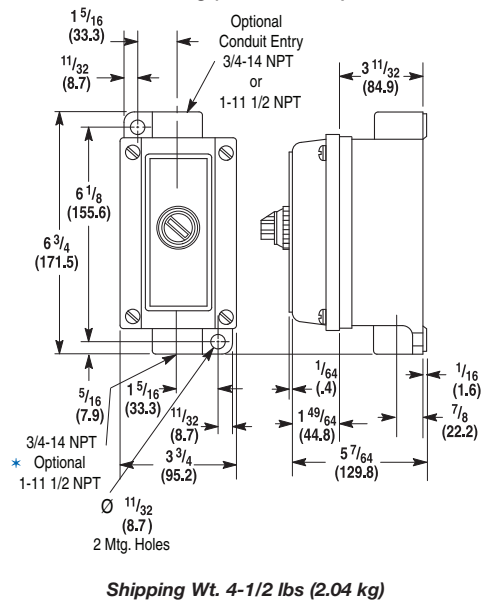

Figure 4
Deep Base Component Lever Type
1-Gang (1 or 2 devices)



* When using a flange seal, an approved drain fitting must be provided (refer to National Electrical Code).

* When used add the following to the max. depth: Flange seal add 3/16 in. (4.8 mm). Sealing well with or without integral flange seal add 1/2 in. (12.7 mm).

Hazardous Location Push Buttons

Approximate Dimensions

Approximate Dimensions and Shipping Weights, Continued

Dimensions in inches (millimeters). Dimensions are not intended to be used for manufacturing purposes.

Factory-Assembled Stations

For depth dimension refer to Figure 3 or 4 on page 10-187.

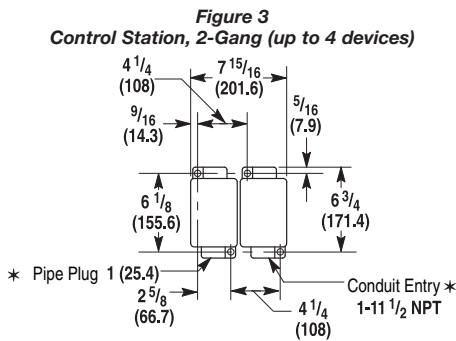

Shipping Wt. 10 lbs (4.54 kg)

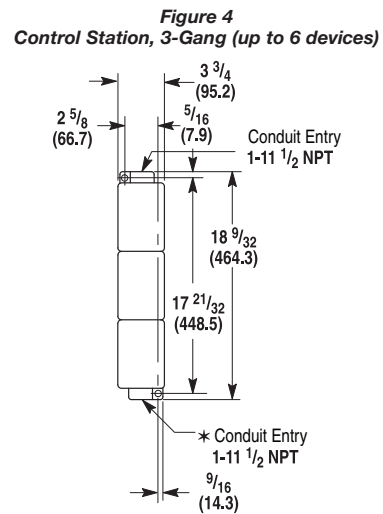

Shipping Wt. 16 lbs (7.26 kg)

Figure 5
Control Station, 2-Gang (up to 4 devices)

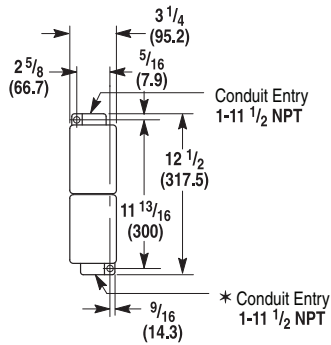

Shipping Wt. 10 lbs (4.54 kg)

Figure 6
Control Station, 4-Gang (up to 8 devices)

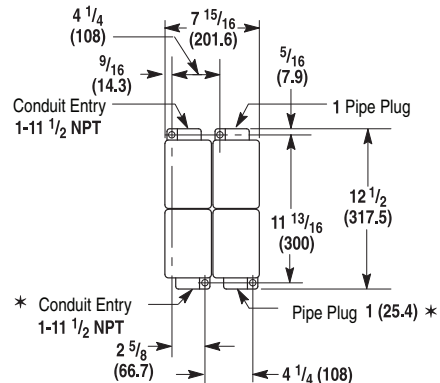

Shipping Wt. 20 lbs (9.07 kg)

Figure 7
Control Station, 6-Gang (up to 12 devices)

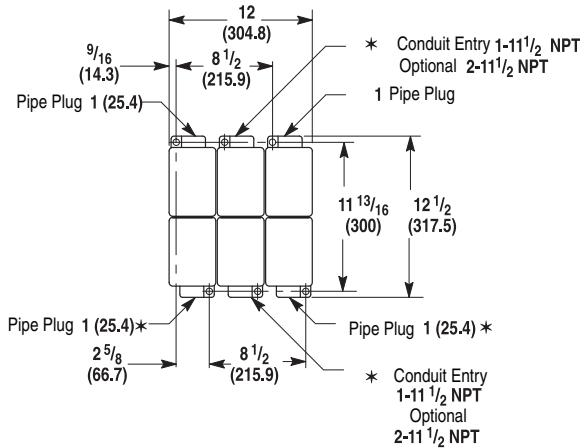

Shipping Wt. 32 lbs (14.5 kg)

Figure 8
Control Station, 8-Gang (up to 16 devices)

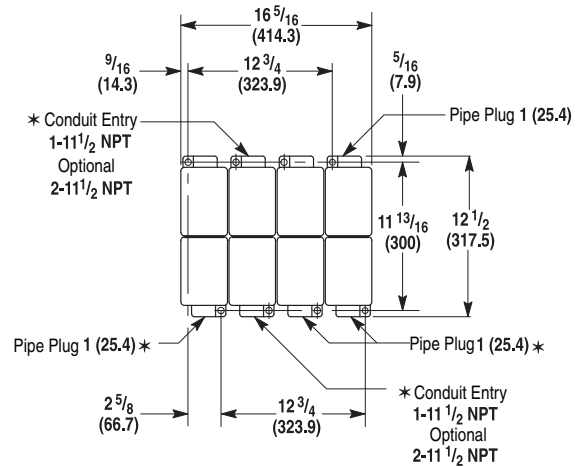

Shipping Wt. 40 lbs (18.1 kg)

30.5 mm Push Button Stations Hermetically Sealed for Division 2/Zone 2

Product Overview

	<p>Bulletin 800R — 30.5 mm Push Button Stations Hermetically Sealed for Division 2/Zone 2</p> <ul style="list-style-type: none"> • Hazardous location push button stations • Classes I and II Division 2/Zone 2 • 30.5 mm mounting hole • Types 4/13 and 4/4X/13 	<p>Table of Contents</p> <p>Specifications..... this page Complete</p> <p>Assembled Stations.. 10-191</p> <p>Custom-Built Stations..... 10-192</p> <p>Enclosures Only 10-192</p> <p>Approximate Dimensions..... 10-193</p>
---	---	---

Specifications*

Electrical Ratings		
Contact Ratings	Refer to the contact ratings (page 10-190).	
Dielectric Strength	2200V for one minute, 1300V for one minute (Logic Reed)	
Electrical Design Life Cycles	1 000 000 at maximum rated load, 200 000 at maximum rated load (Logic Reed)	
Mechanical Ratings		
Vibration	10...2000 Hz 1.52 mm displacement (peak-to-peak) Max./10 G Max. (except Logic Reed)	
Shock	1/2 cycle sine wave for 11 ms ≥25 G (contact fragility) and no damage at 100 G	
Degree of Protection	Type 4/4X/13, 4/13; Watertight/Corrosion-Resistant IEC 529 IP66/65	
Mechanical Design Life Cycles		
Push Buttons	(Momentary, Non-Illuminated) (Momentary, Illuminated) (Push-Pull/Twist-to-Release)	1 000 000 min. 250 000 min. 250 000 min.
Selector Switches	(Non-Illuminated) (Illuminated)	1 000 000 min. 200 000 min.
All other devices		200 000 min.
Contact Operation	Logic Reed and sealed switch contact blocks: single break magnetic	
Typical Operating Forces		
Operators without contact blocks	Flush, extended, standard mushroom, jumbo plastic mushroom: 2 lb max. Maintained selector switch: 3.6 in•lb maximum	
Spring Return Selector Switches	3.6 in•lb to stop 0.2 in•lb to return	
Illuminated Push Buttons and Push-to-Test Pilot Lights	5 lb maximum	
3-Position Push-Pull	8 lb maximum push to in position or pull to center position (15 lb maximum pull to out position)	
Push-Pull and Push-Pull/Twist	9 lb maximum push or pull 30 in•oz maximum twist, 6 in•oz minimum return	
Contact Blocks	Logic Reed Sealed Switch Stackable Sealed Switch	1 lb maximum 3 lb maximum at 0.205 in. plunger travel 1 lb maximum
Environment		
Temperature Range	Operating Storage	-40...+131 °F (-40...+55 °C) -40...+185 °F (-40...+85 °C)
Note: Operating temperatures below freezing are based on the absence of moisture and liquids. Consult your local Rockwell Automation sales office or Allen-Bradley distributor for use in lower temperature applications.		
Humidity		50% at 104 °F (40 °C)

* Performance Data — See page Important-3.

30.5 mm Push Button Stations Hermetically Sealed for Division 2/Zone 2

Product Overview

Control Stations

Bulletin 800R control stations are designed for Division 2/Zone 2 hazardous locations. They consist of Bulletin 800H (Type 4/4X/13) or Bulletin 800T (Type 4/13) operators with sealed contact blocks. Bulletin 800R units are available as factory assembled stations or as components for field assembly.

Hazardous Locations

Since the contacts are enclosed in a hermetically sealed chamber, the contact block is suitable for use in Class I and II, Division 2/Zone 2 Groups A, B, C, D, F and G hazardous locations and is listed by Underwriters Laboratories for this class of service.

Complete stations as shown on page 2-23 can be used for Class I and II Division 2/Zone 2 applications. The individual components shown in the 800T and 800H sections are also suitable for Class I and II Division 2/Zone 2 locations providing they are suitably mounted by the customer in an enclosure as required for the application and by applicable codes and laws.

Per National Electrical Code: Zone 2. In Class I, Zone 2 locations, all wiring methods permitted for Class I, Division 2, Class I, Division 1 or Division 2, and Class I, Zone 0 or Zone 1 locations, including requirements for sealing, shall be permitted.

Note: Allen-Bradley Logic Reed contact blocks are also listed by Underwriters Laboratories for the Division 2/Zone 2 hazardous locations listed above.



CAUTION:

The complete stations and individual components listed herein **are not suitable for use in Class I and II Division 1 hazardous locations**. For Class I and II Division 1 hazardous locations, order Bulletin 800H Type 7 & 9 stations and units.

Sealed Switch Contact Ratings

Maximum continuous current I_{th} 5 A. Bulletin 800T and 800H units have control circuit ratings with sealed switch contact blocks as follows:

Max. Opertrnl. Volts U_e	Utilization Category		Rated Operational Currents		
	IEC	NEMA	Volts U_e	Make	Break
AC 600	AC-15	B600	120...600 0...120	3600 VA 30 A	360 VA 3 A
DC 300	DC-13	P300	24...300 0...24	138 VA 5.0 A	

Stackable Sealed Switch Contact Ratings

Maximum continuous current I_{th} 2.5 A. Bulletin 800T and 800H units have control circuit ratings with sealed switch contact blocks as follows:

Max. Opertrnl. Volts U_e	Utilization Category		Rated Operational Currents		
	IEC	NEMA	Volts U_e	Make	Break
AC 300	AC-15	C300	120...300 0...120	1800 VA 15 A	180 VA 1.5 A
DC 150	DC-13	Q150	24...150 0...24	69 VA 2.5 A	

Logic Reed Contact Ratings

Maximum DC: 30V, 0.06 A Maximum AC: 150V, 0.15 A
Should only be used with resistive loads.

Standards Compliance

- UL 1604
- CSA C22.2, No. 213

Certifications

- UL Listed (File No. E10314, Guide No. NOIV)
- CSA Certified (File No. LR11924)

30.5 mm Push Button Stations Hermetically Sealed for Division 2/Zone 2

Product Selection

Complete Assembled Stations

Class I, Division 2/Zone 2

Push button operators for Class I, Division 2/Zone 2 are offered in Bulletin 800T/H, page 10-2.



Surface Mount
Cat. No. 800R-1TA



Stainless Steel
Booted Operator Station
Cat. No. 800R-1HA4T



Stainless Steel
Bootless Operator Station
Cat. No. 800R-1HA4TL



Rosite
Booted Operator Station
Cat. No. 800R-1HA4R



Rosite
Bootless Operator Station
Cat. No. 800R-1HA4RL

Operator	Contact Symbol	Contact Action	Button Type	Button Color	Legend Marking	Cast Aluminum Enclosures*	Stainless Steel Enclosures*	Rosite Glass Polyester Enclosures*	
						Surface Mount	Bootless Operator Station†		
						Cat. No.	Cat. No.	Cat. No.	
One Push Button		1 N.O. - 1 N.C.	Momentary	Flush	Green	START	800R-1TB	800R-1HB4TL	800R-1HB4RL
				Extended	Red	STOP	800R-1TA	800R-1HA4TL	800R-1HA4RL
				Flush	Black	No Legend	800R-1TX	800R-1HX4TL	800R-1HX4RL
Two Push Buttons		1 N.O. - 1 N.C. Each Button	Momentary	Flush Extended	Green Red	START STOP	800R-2TA	800R-2HA4TL	800R-2HA4RL
				Flush Flush	Black Black	No Legend No Legend	800R-2TX	800R-2HX4TL	800R-2HX4RL
One Pilot Light, Two Push Buttons		1 N.O. - 1 N.C. Each Button	Momentary	120V AC Flush Extended	Red Green Red	No Legend START STOP	800R-2TAR	800R-2HAR4TL	800R-2HAR4RL
				120V AC Flush Flush	Red Black Black	No Legend No Legend No Legend	800R-2TXR	800R-2HXR4TL	800R-2HXR4RL
3-Position Selector Switch		1 N.O. - 1 N.C.	Maintained	Knob Lever	Black with white insert	HAND OFF AUTO	800R-R3TA	800R-R3HA4TL	800R-R3HA4RL
				Knob Lever	Black with white insert	No Legend	800R-R3TX	800R-R3HX4TL	800R-R3HX4RL
One Push Button		1 N.O. - 1 N.C.	Maintained	Push-Pull/Twist	Red	EMRG.STOP	800R-1TAM	800R-1HAM4TL	800R-1HAM4RL
Two Push Buttons		1 N.O. - 1 N.C. Each Button	Maintained	Flush Extended	Green Red	START STOP	800R-2TAM	800R-2HAM4TL	800R-2HAM4RL
				Flush Flush	Black Black	No Legend No Legend	800R-2TXM	800R-2HXM4TL	800R-2HXM4RL

* Type 4/13.

* Type 4/4X/13.

† To order a control station with booted operators, remove the L from the end of the catalog number.

Example: Cat. No. 800R-1HA4TL becomes Cat. No. 800R-1HA4T.

30.5 mm Push Button Stations Hermetically Sealed for Division 2/Zone 2

Product Selection

Custom-Built Stations



Description

The tables on page 10-191 list the most commonly used push button stations. Stations not listed in the table may be ordered as custom-built stations.

Cat. No.

The cat. no. used to identify custom-built Bulletin 800R push button stations, which are built at the factory, will be cat. nos. listed for the enclosure only, except letter **W** will be substituted for the letter **Z** and with a station serial number.

Ordering Information

The following information is required when ordering custom built push button stations.

1. Cat. no. of enclosure.
2. Cat. no. of control units.
3. Legend plate cat. no. and/or marking for each unit.
4. Specify vertical or horizontal mounting.
5. Specify desired operator mounting sequence. Inclusion of a sketch is recommended. If no information is given, standard configuration will be used.

Enclosures Only



Die Cast
Cat. No. 800R-2TZ



Stainless Steel
Cat. No. 800R-2HZ4



Rosite Glass Polyester
Cat. No. 800R-2HZ4R

Units*	Die Cast (Type 4/13)	Stainless Steel (Type 4/4X/13)	Rosite Glass Polyester (Type 4/4X/13)
	Cat. No.	Cat. No.	Cat. No.
1	800R-1TZ	800R-1HZ4	800R-1HZ4R
2	800R-2TZ	800R-2HZ4	800R-2HZ4R
3	800R-3TZ	800R-3HZ4	800R-3HZ4R
4	800R-4TZ	800R-4HZ4	800R-4HZ4R
5	—	800R-5HZ4	—
6	800R-6TZ	800R-6HZ4	800R-6HZ4R

* Number of units that can be mounted in enclosure.

* Extra deep. Accommodates two levels of stackable sealed switch contact blocks.

Note: Enclosure and conduit dimensions are detailed on page 10-193, except for the fiberglass enclosures, which are found on 10-64.

30.5 mm Push Button Stations Hermetically Sealed for Division 2/Zone 2

Product Overview

Approximate Dimensions and Shipping Weights

Dimensions in inches (millimeters). Dimensions are not intended to be used for manufacturing purposes.

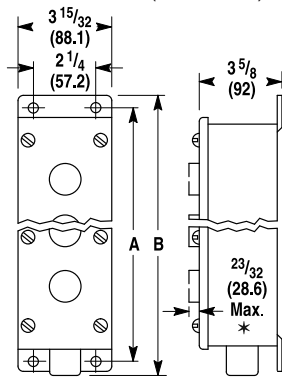

**Type 4/4X/13
Stainless Steel**

**Watertight/Oiltight/Corrosion-Resistant
Enclosure**

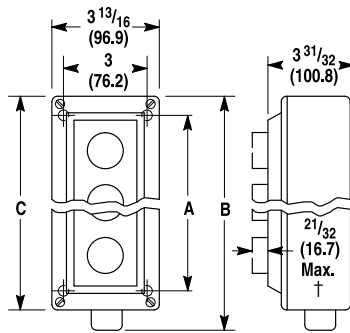

**Type 4/4X/13
Rosite Glass Polyester**

Watertight/Oiltight/Corrosion-Resistant Enclosure

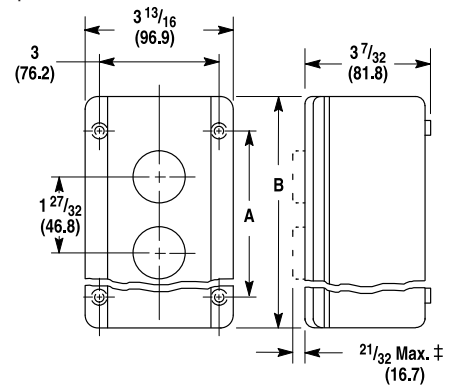

**Type 4/13
Cast Aluminum Enclosure**

Watertight/Oiltight

Dimension	Number of Units					
	1	2	3	4	5	6
Stainless Steel Type 4/4X/13						
A	5-5/32 (135)	7 (178)	8-27/32 (225)	10-11/16 (271)	12-17/32 (318)	14-3/8 (360)
B	6-13/32 (163)	8-1/4 (210)	10-1/8 (257)	11-31/32 (304)	14-1/32 (359)	15-7/8 (403)
Pipe Tap Size	3/4				1	
Glass Polyester Type 4/4X/13						
A	4-1/2 (114)	4-1/2 (114)	6-1/4 (159)	8 (203)	12-1/8 (308)	12-1/8 (308)
B	7-1/32 (181)	7-1/32 (181)	8-23/32 (221)	10-21/32 (271)	14-7/8 (378)	14-7/8 (378)
C	5-7/8 (149)	5-7/8 (149)	7-9/16 (192)	9-1/2 (241)	13-1/2 (343)	13-1/2 (343)
Pipe Tap Size	3/4				1	
Cast Aluminum Type 4/13						
A	2-3/4 (69.8)	4-1/2 (114)	6-1/4 (159)	8 (203)	—	12-1/8 (308)
B	4-3/16 (106)	5-7/8 (149)	7-9/16 (192)	9-1/2 (241)	—	13-1/2 (343)
Conduit Opening	3/4 in. 14 N.P.T.				1 in. 11-1/2 N.P.T.	

- * Selector switch is 1-5/32 (29.4) maximum; pilot light is 1-7/32 (31).
- ⊛ Selector switch is 1-3/32 (27.8) maximum; pilot light is 1-5/32 (29.4) maximum.
- ‡ Selector switch is 1-7/32 (30.9) maximum; pilot light is 1-9/32 (32.5).
- § Minimum vertical spacing dimension for jumbo legend plate is 2-15/32 (62.7).

Operator Extension in Front of Panel*

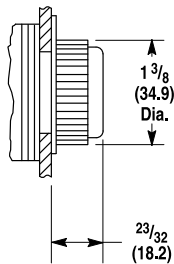

**Type 4/4X/13
Booted Flush and Extended Head Push Button**

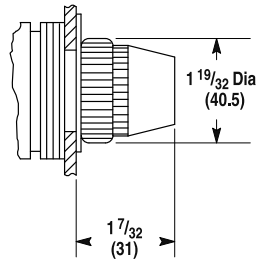

**Type 4/4X/13
Pilot Light**

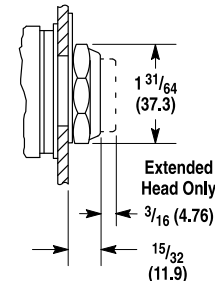

**Type 4/13 and Type 4/4X/13
Bootless Flush and Extended Head Push Button**

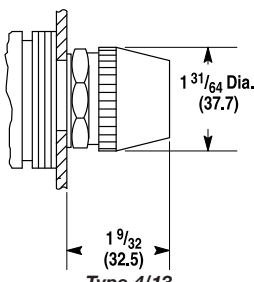

**Type 4/13
Pilot Light**

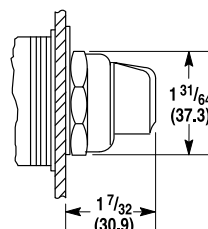

**Type 4/13 and Type 4/4X/13
Standard Knob Selector Switches**

Mounting Instructions (for Panel Mounting)

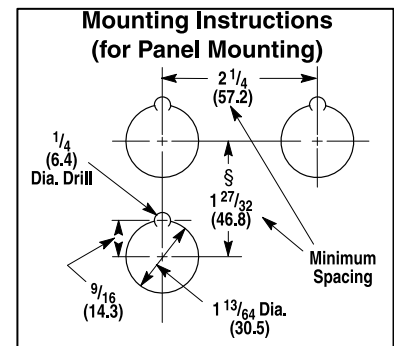

* See 10-49...10-56 for additional Type 4/13 outlines and for additional Type 4/4X/13 outlines.

Hazardous Location Push Buttons

Product Overview/Specifications

	<p>Bulletin 800G — Hazardous Location Push Buttons</p> <ul style="list-style-type: none"> • IP66, Type 4X • Class I, Zone 1 and Zone 2 • Class I/Division 2 — Groups A, B, C, and D 	<p>Table of Contents</p> <p>See below.</p>
---	---	---

TABLE OF CONTENTS

Description	Page
Complete Assembled Stations	10-197
Push Buttons	10-199
Mushroom	10-199
Key Release	10-200
Selector Switch	10-200
Pilot Light	10-201

Description	Page
Ammeter	10-201
Enclosures	10-201
Back-of-Panel Components	10-202
Accessories	10-203
Legend Plates	10-204
Approximate Dimensions	10-207

Specifications

Standard Assembled Stations

	Mechanical Ratings
Protection Type	 II 2G Ex edm IIC T6 AEx edm IIC T6 Ex edm IIC T6
Certification	PTB 01 ATEX 1036 UL E10314 CE0044
Rated Insulation Voltage	Max. 690V AC
Rated current	Dependent on components used
Degree of Protection	IP66, Type 4X: -20...+60 °C (-4...+140 °F) IP54: -55...+60 °C (-67...+140 °F)
Enclosure Material	
Enclosure	Thermoplastic
Seals	EPDM
Cable Glands	
Standard	Plastic M20 x 1.5 for cable Ø 6...12 mm
Custom	Plastic M25 for cable Ø 13...18 mm 1/2 in. NPT conduit 3/4 in. NPT conduit
Wire/Cable Size	2.5 mm ² (12 AWG) stranded max.
PE Conductor Terminals	4 x 2.5 mm ² (12 AWG) stranded max.
Storage Temperature	-55...+70 °C (-67...+158 °F)
Operational Temperature Range	-55...+60 °C (-67...+140 °F)

Assembled Stations

Bulletin 800G control stations are designed for Class I, Zone 1 and 2 and Class I/Division 2 hazardous location applications. They consist of Bulletin 800G front-of-panel components with back-of-panel components: contact blocks or power modules. Bulletin 800G units are available as factory assembled stations or as components for component replacement. Field assembled stations used in a Class I, Zone 1 or Zone 2 application must be inspected and certified by a third party.

Components

Since the back-of-panel components are enclosed in a flame-proof enclosure, they are suitable for use in **Class I, Zone 1 and Zone 2 Groups IIA, IIB, and IIC and Class I/Division 2, Groups A, B, C, and D hazardous locations and is listed by Underwriters Laboratories and certified by PTB for this class of service.** The components have “d” and “e” protection methods except for the cable termination. Cable termination has only “d” protection method, restricted by the cable and not the contacts.





CAUTION:
The assembled stations and individual components listed herein are not suitable for the use in Zone 0, Class I/Division 1 and Class II/Division 1 and Division 2 applications. For Class I and II/Division 1 hazardous locations, order Bulletin 800H Type 7 & 9 stations and units. For Class II/Division 2 hazardous locations, order Bulletin 800R stations.





Back-of-Panel

Contact Block

Electrical Ratings						
	Screw Termination			Cable Termination		
Rated Insulation Voltage	690V			400V (Limited by the cable, not the contacts)		
Rated Voltage	250V (per ATEX certificates)		24V	250V (per ATEX certificates)		24V
Rated Operating Currents	16 A	10 A	1 A	16 A	10 A	1 A
Utilization Category	AC-12	AC-15	DC-13	AC-12	AC-15	DC-13
Thermal Continuous Current	16 A at 40 °C (104 °F), 11 A at 60 °C (140 °F)			16 A at 40 °C (104 °F), 11 A at 60 °C (140 °F)		
Contact Rating per UL 508	A600		P600	A600		P600
Max. Rated Voltage per UL Contact Rating	600V		600V	600V		600V
Max. "Make" Current at Rated Voltage per UL Contact Rating	12 A		0.2 A	12 A		0.2 A
Max. "Break" Current at Rated Voltage per UL Contact Rating	1.2 A		0.2 A	1.2 A		0.2 A
Thermal Continuous Test Current per UL Contact Rating	10 A		5 A	10 A		5 A
Short Circuit Protection	10 A Slow Blow, Type DT, gl			10 A Slow Blow, Type DT, gl		
Mechanical Ratings						
Protection Type	 II 2G Ex de IIC Class I, Zone 1 AEx de IIC Class I, Zone 1 Ex de IIC			 II 2G Ex d IIC T6 Class I, Zone 1 AEx d IIC T6 Class I, Zone 1 Ex d IIC T6		
Certification	PTB 01 ATEX 1040U UL E10314			PTB 01 ATEX 1039X UL E10314		
Contact Options	1 N.O. - 1 N.C. 2 N.O. 2 N.C.			1 N.O. - 1 N.C. 2 N.O. 2 N.C.		
Contact Material	AgSnO ₂			AgSnO ₂		
Housing Material	Thermoplastic			Thermoplastic		
Physical Shock Resistance	DIN IEC 68 part 2-27, 30 g 18 ms			DIN IEC 68 part 2-27, 30 g 18 ms		
Design Life	1 000 000 cycle mechanical life			1 000 000 cycle mechanical life		
Operating Force (Maximum)	22.2 N (5 lb) to open N.C. 15.6 N (3.5 lb) to close N.O. 28.9 N (6.5 lb) full travel			22.2 N (5 lb) to open N.C. 15.6 N (3.5 lb) to close N.O. 28.9 N (6.5 lb) full travel		
Temperature (Storage/Transport)	-55...+70 °C (-67...+158 °F)			-55...+70 °C (-67...+158 °F)		
Operational Temperature Range	-55...+60 °C (-67...+140 °F)			-55...+60 °C (-67...+140 °F)		
Wire/Cable Size	2.5 mm ² (12 AWG) stranded max.			3 m (9.8 ft) long cable 4 x 1.5 mm ² (9.1 mm/0.36 in. OD)		
Degree of Protection	IP20, with operators and enclosure IP66			With operators IP67		
Mounting	Base Mount: Secures to rail integral to enclosure base Panel Mount: Secures to operator with integral latch			Panel Mount: Secures to operator with integral latch		

Power Module

Electrical Ratings						
	Screw Termination			Cable Termination		
Rated Insulation Voltage	300V			300V		
Power Consumption	≤ 1 W			≤ 1 W		
Lamp	Multi-LED (Red, Yellow, Green, White, Blue)			Multi-LED (Red, Yellow, Green, White, Blue)		
Rated Voltage	12...60V DC 12...250V AC			24...60V DC 24...60V AC and 110...250V AC		
Mechanical Ratings						
	Screw Termination			Cable Termination		
Protection Type	 II 2G Ex de IIC Class I, Zone 1 AEx de IIC Class I, Zone 1 Ex de IIC			 II 2G Ex d IIC T6 Class I, Zone 1 AEx d IIC T6 Class I, Zone 1 Ex d IIC T6		
Certifications	PTB 01 ATEX 1037U UL E10314			PTB 01 ATEX 1038X UL E10314		
Housing Material	Thermoplastic			Thermoplastic		
Physical Shock Resistance	DIN IEC 68 part 2-27, 30 g, 18 ms			DIN IEC 68 part 2-27, 30 g, 18 ms		
Design Life	100 000 hours			100 000 hours		
Storage/Transport Temperature	-55...+70 °C (-67...+158 °F)			-55...+70 °C (-67...+158 °F)		
Ambient Temperature Range	-55...+60 °C (-67...+140 °F)			-55...+60 °C (-67...+140 °F)		
Wire/Cable Size	2.5 mm ² (12 AWG) stranded max.			3 m (9.8 ft) long cable 4 x 1.5 mm ² (9.1 mm/0.36 in. OD)		
Degree of Protection	IP20, with operators and enclosure IP66			With operators IP67		
Mounting	Base Mount: Secures to rail integral to enclosure base Panel Mount: Secures to operator with integral latch			Panel Mount: Secures to operator with integral latch		





Hazardous Location Push Buttons

Specifications

Back-of-Panel, Continued

Power Module/Contact Block Combination





Electrical Ratings				
	Screw Termination		Cable Termination	
Rated Insulation Voltage	300V		300V	
Power Consumption	≤ 1 W		≤ 1 W	
Lamp	Multi-LED (red, yellow, green, white, blue)		Multi-LED (red, yellow, green, white, blue)	
Rated Voltage	24...48V DC 24...250V AC		24...48V DC 24...250V AC	
Contact Rating per UL 508	A600	P600	A600	P600
Thermal Continuous Current	1 A	0.25 A	1 A	0.25 A
Max. Rated Voltage	600V	600V	600V	600V
Mechanical Ratings				
	Screw Termination		Cable Termination	
Protection Type	 II 2G EEx de IIC Class I, Zone 1 AEx de IIC Class I, Zone 1 Ex de IIC		 II 2G EEx d IIC T6 Class I, Zone 1 AEx d IIC T6 Class I, Zone 1 Ex d IIC T6	
Certifications	PTB 01 ATEX 1037U UL E10314		PTB 01 ATEX 1038X UL E10314	
Housing Material	Thermoplastic		Thermoplastic	
Physical Shock Resistance	DIN IEC 68 part 2-27, 30 g, 18 ms		DIN IEC 68 part 2-27, 30 g, 18 ms	
Design Life	100 000 hours		100 000 hours	
Storage/Transport Temperature	-55...+70 °C (-67...+158 °F)		-30 ...+70 °C (-22...+158 °F)	
Ambient Temperature Range	-55...+60 °C (-67...+140 °F)		-30...+60 °C (-22...+140 °F)	
Wire/Cable Size	2.5 mm ² (12 AWG) stranded max.		3 m (9.8 ft) long cable 4 x 1.5 mm ² (9.1 mm/0.36 in. OD)	
Degree of Protection	IP20, with operators and enclosure IP66		With operators IP67	
Mounting	Base Mount: Secures to rail integral to enclosure base Panel Mount: Secures to operator with integral latch		Panel Mount: Secures to operator with integral latch	

Front-of-Panel Operators

Mechanical Ratings							
Device	Operational Temperature	Operating Force *	Mechanical Design Life	Impact Resistance	Materials	Ingress Protection	Ex Protection Type
Push Button	-55...+70 °C (-67...+158 °F)	6.7 N (1.5 lb)	1 000 000 cycles	7 N•m	Thermoplastic Housing EPDM Seals	IP66 : -20...+70 °C (-4...+158 °F)	 II 2G EEx e II PTB 01 ATEX 1035U UL E10314
Selector Switch	-55...+70 °C (-67...+158 °F)	—					
Key Release Push Button	-55...+70 °C (-67...+158 °F)	15.6 N (3.5 lb)					
Key Release Mushroom	-55...+70 °C (-67...+158 °F)	15.6 N (3.5 lb)					
Mushroom	-55...+70 °C (-67...+158 °F)	6.7 N (1.5 lb)					
E-Stop	-55...+70 °C (-67...+158 °F)	44.5 N Push/ 89 N Pull (10 lb Push/ 20 lb Pull)	6000 cycles			IP54: -55...-20 °C (-67...-4 °F)	
Pilot Light (Red, Yellow, White, Green, Blue)	-55...+70 °C (-67...+158 °F)	—	N/A	4 N•m		Type 4X: -20...+70 °C (-4...+158 °F)	
Hole Plug	-55...+70 °C (-67...+158 °F)	—	N/A	7 N•m			
Illuminated Push Button	-55...+70 °C (-67...+158 °F)	6.7 N (1.5 lb)	1 x 10 ⁶	7 N•m			
Key Selector Switch	-55...+70 °C (-67...+158 °F)	—	1 000 000 cycles	7 N•m			

* Does not include contact block.

Product Selection
Complete Assembled Stations

Enclosure Type	Button Type/Color	Legend Marking	Cat. No.
One-hole  Cat. No. 800G-1E4A3	Black push button	No legend	800G-1F2A3
	E-Stop	Emergency Stop/Arrêt D'urgence	800G-1E4A3
	Mushroom key release	No legend	800G-1B4A3
	2-position maintained selector switch	No legend	800G-1HMA3
Two-hole  Cat. No. 800G-2FAAFBA3	2 black push buttons	No legends	800G-2F2AF2A3
	Green push button Red push button	No legends	800G-2F3AF4A3
	Green push button Red push button	START STOP	800G-2FAAFBA3
Three-hole  Cat. No. 800G-3P4DF3AF4A3	Red LED Green push button Red push button	No legends	800G-3P4DF3AF4A3
	Red LED Green push button Red push button	No legend START STOP	800G-3P4DFAAFBA3
	Green push button Red push button E-Stop push/pull	No legend No legend Emergency Stop/Arrêt D'urgence	800G-3F3AF4AE4A3
	Green push button Red push button E-Stop push/pull	START STOP Emergency Stop/Arrêt D'urgence	800G-3FAAFBAE4A3
	1 A ammeter 2-position maintained selector switch	No legends	800G-3M1XHMA3
Ammeter + 1 operator  Cat. No. 800G-3M1XHMA3	5 A ammeter 2-position maintained selector switch	No legends	800G-3M5XHMA3

Hazardous Location Push Buttons

Product Selection

Complete Assembled Stations, Continued

800G – 2 F 3 M F 4 N 3

a *b* *c* *d* *b* *c* *d* *b* *c* *d* *e*

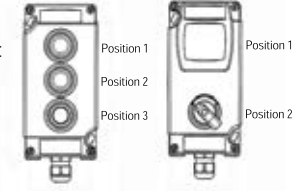

Enclosure Size	
Code	Description
1	1-hole
2	2-hole
3	3-hole

Operator/Meter	
Code	Description
B	Key release mushroom push button*
D	Momentary mushroom push button*
E	Push-pull mushroom push button*
F	Non-illuminated flush push button*
H	2-position selector switch*
J	3-position selector switch*
K	Key release push button
L	Illuminated push button — flush*
M	Ammeter§
N	Hole plug*
P	Pilot light*

- * Only available in red.
- ⊛ Only available in black.
- § For ammeter, choose 3-hole enclosure with meter in pos. 1 and either an operator or hole plug in pos. 2 (i.e., Cat. No. 800G-3 M1X J1A or Cat. No. 800G-3 M1X N2X)
- ♣ Only available in white, green, red, yellow, and blue.
- ⌘ Only available for 3-position selector switch.
- ⬆ For through-feed enclosure, selected conduit entry will be applied for both bottom and top entry.
- ⚡ For use with illuminated push button only.
- ♣ Only available in white, black, green, red, or yellow.

Push Button Color/Text	
Code	Description
1	White
2	Black
3	Green
4	Red
5	Yellow
6	Blue
A	START (green background/white text)
B	STOP (red background/white text)
G	I (green background/white text)
H	O (red background/white text)
J	ON (green background/white text)
K	OFF (red background/white text)

Key Release	
1	Lockable in initial position, key removal in initial position
2	Lockable in both positions, key removal in both positions
3	Lockable in depressed position, key removal in depressed position

Selector Switch	
M	Maintained in all positions
B	Spring return from both positions⌘
L	Spring return from left⌘
R	Spring return from right⌘

Meters§	
1	1 A
5	5 A

Contact Block/Lamp Module	
Code	Description
A	1 N.O. - 1 N.C. base mount
M	2 N.O. base mount
N	2 N.C. base mount
D	Lamp module base mount (same color as requested lens color in Table c)
X	N/A (i.e., ammeter, hole plug)
K	1 N.O. with lamp module⚡
L	1 N.C. with lamp module⚡

Conduit Entry	
Bottom Entry	
Code	Description
Blank	M20X1.5 threaded hole
1	1/2 in. NPT conduit hub
2	3/4 in. NPT conduit hub
3	1 M20 plastic cable gland for cable diameter 6...12 mm
4	1 M25 plastic cable gland for cable diameter 13...18 mm
5	M20 blind plug
6	M25 blind plug
7	2 M20 plastic cable gland
8	1 M20 metal cable gland
9	1 M25 metal cable gland
0	2 M20 metal cable gland

Top Entry	
A	M20X1.5 threaded hole
B	1/2 in. NPT conduit hub
C	3/4 in. NPT conduit hub
D	1 M20 plastic cable gland for cable diameter 6...12 mm
E	1 M25 plastic cable gland for cable diameter 13...18 mm
F	M20 blind plug
G	M25 blind plug
H	2 M20 plastic cable gland
J	1 M20 metal cable gland
K	1 M25 metal cable gland
L	2 M20 metal cable gland

Through Feed⬆	
M	M20X1.5 threaded hole
N	1/2 in. NPT conduit hub
P	3/4 in. NPT conduit hub
Q	1 M20 plastic cable gland for cable diameter 6...12 mm
R	1 M25 plastic cable gland for cable diameter 13...18 mm
T	M20 blind plug
U	M25 blind plug
V	2 M20 plastic cable gland
W	1 M20 metal cable gland
X	1 M25 metal cable gland
Y	2 M20 metal cable gland

Hazardous Location Push Buttons

Product Selection

Push Button, Non-Illuminated — Flush



Cat. No. 800G-F3

Flush-Round	
Color	Cat. No.
White	800G-F1
Black	800G-F2
Green	800G-F3
Red	800G-F4
Yellow	800G-F5

800G - $\frac{F}{a}$ $\frac{3}{b}$

Operator Construction	
Code	Description
F	Flush operator

Color	
Code	Description
1	White
2	Black
3	Green
4	Red
5	Yellow

Double Push Button, Non-Illuminated — Flush



Cat. No. 800G-U2FX



Cat. No. 800G-V2FX

Description	Cat. No.*
Double push button with curved base for use with Bul. 800G enclosures.	800G-U2FX
Double push button with flat base for use with customer provided enclosures.	800G-V2FX

* All double push buttons come with a multi-pack of color caps (red, green, black, white, and yellow).

Push Button, Illuminated — Flush



Cat. No. 800G-LF3

Color	Cat. No.
White	800G-LF1
Green	800G-LF3
Red	800G-LF4
Yellow	800G-LF5
Blue	800G-LF6

800G - $\frac{LF}{a}$ $\frac{3}{b}$

Operator Construction	
Code	Description
LF	Illuminated flush operator

Color	
Code	Description
1	White
3	Green
4	Red
5	Yellow
6	Blue

Mushroom — Non-Illuminated and Key Release



Momentary Mushroom
Cat. No. 800G-M2



Key Release Mushroom
Cat. No. 800G-MKE



Push-Pull Mushroom
Cat. No. 800G-MPE

Color/Feature	Momentary Mushroom	Key Release Mushroom	Push-Pull
	Cat. No.	Cat. No.	Cat. No.
Black w/black bezel	800G-M2	—	—
E-Stop red w/ yellow bezel *	—	800G-MKE	800G-MPE

800G - $\frac{M}{a}$ $\frac{2}{b}$

Operator Style	
Code	Description
M	Momentary
* MP	Push-pull
* MK	Key release

Color or Feature	
Code	Color
2	Black with black bezel
E	Red E-stop with yellow bezel and printing on head

* Only available in E-stop, option E from Table b.

Hazardous Location Push Buttons

Product Selection

Key Release



Cat. No. 800G-K14

Operator Style	Locking Position	Cat. No.
Key Release Push Button	Lockable in initial position, key removal in initial position	800G-K14
	Lockable in both positions, key removal in both positions	800G-K16
	Lockable in depressed position, key removal in depressed position	800G-K24

800G -
 a b
 a

Operator Style	
Code	Description
K	Key release push button

b

Locking Position	
Code	Description
14	Lockable in initial position; key removal in initial position
16	Lockable in both positions; key removal in both positions
24	Lockable in depressed position; key removal in depressed position

Selector Switch — Knob & Key Operated



Knob Selector Switch
 Cat. No. 800G-SM3



Key Operated Switch
 Cat. No. 800G-KSM33H

800G -
 a b c d
 a

Operator Style	
Code	Description
S	Knob
KS	Key operated

2-Position Target Table

Contact Type		
N.O.	O	X
N.C.	X	O

3-Position Target Table

Contact Type	Pos. on Latch or Base			
N.O.	Top	O	O	X
	Bottom	X	O	O
N.C.	Top	X	X	O
	Bottom	O	X	X

b

No. of Positions/Functions	
Code	Description
M2	2-position maintained
B3	3-position spring return left and right to center
L3	3-position spring return left to center
M3	3-position maintained
R2	2-position spring return right to left
R3	3-position spring return right to center

Operator Style	Positions/Functions	Knob Selector Switch	
		Cat. No.	
2-Position	Maintained	800G-SM2	
3-Position	S→M←S	800G-SB3	
	S→M M	800G-SL3	
	Maintained	800G-SM3	
	M M←S	800G-SR3	

c

Key Removal	
Code	Description
Blank	For knob selector switches
* 1	Left
* 2	Right
* 3	All
* 4	Center
* 5	Left/center
* 6	Left/right
* 7	Right/center

Operator Style	Positions/Functions	Key Removal Position	Key Operated Switch
			Cat. No.
2-Position	Maintained	All	800G-KSM23H
3-Position	S→M←S	Center	800G-KSB34H
	S→M M	Right/center	800G-KSL37H
	Maintained	All	800G-KSM33H
	M M←S	Left/center	800G-KSR35H

d

Knob Position	
Code	Description
* Blank	For latch mount or base mount in horizontal Bul. 800G enclosure
H	For base mount in vertical Bul. 800G enclosure

* Only available with key selector (Code **KS** from Table a).
 * Only available with knob selector (Code **S** from Table a).

Hazardous Location Push Buttons

Product Selection

Pilot Light



Cat. No. 800G-P3

Operator Style	Color	Cat. No.
Pilot Light	White	800G-P1
	Green	800G-P3
	Red	800G-P4
	Yellow	800G-P5
	Blue	800G-P6

800G - $\frac{P}{a}$ $\frac{3}{b}$
 $\frac{a}{a}$

Operator Style	
Code	Description
P	Pilot light

b

Lens Color	
Code	Color
1	White
3	Green
4	Red
5	Yellow
6	Blue

Ammeter



Cat. No. 800G-AMP1B

Base Mount	
Amperage*	Cat. No.
1 A	800G-AMP1B
5 A	800G-AMP5B

* Unit ships with a percent scale plate.

Enclosures — Plastic*

Base mount only



Cat. No. 800G-1P

Type	Type	
	M20 Threaded Hole — Bottom Feed	3/4 in. Conduit — Bottom Feed
Type	Cat. No.	Cat. No.
1-Hole	800G-1P	800G-1P2
2-Hole	800G-2P	800G-2P2
3-Hole	800G-3P	800G-3P2
Ammeter Station	800G-3PA	800G-3PA2

* Bul. 800G enclosures are base mount only and will only work with base mount contact blocks.

800G - $\frac{3}{a}$ $\frac{P}{b}$ $\frac{T}{c}$ $\frac{1}{d}$

a

Enclosure Size	
Code	Description
1	1-hole
2	2-hole
3	3-hole

b

Enclosure Style	
Code	Description
P	Plastic
PA	Plastic with ammeter window*

* Only available in Enclosure Size 3.

c

Conduit Entry	
Code	Description
Blank	Bottom feed
T	Top feed
F	Through feed
X	No holes

d

Conduit Style	
Code	Description
Blank	M20 x 1.5 threaded hole
1	1/2 in. NPT conduit hub
2	3/4 in. NPT conduit hub
3	M20 plastic cable gland
4	M25 plastic cable gland
5	M20 blind plug
6	M25 blind plug
7	Two M20 plastic cable glands
8	M20 metal cable gland
9	M25 metal cable gland
0	Two M20 metal cable glands

Hazardous Location Push Buttons

Product Selection

Back-of-Panel Components

Latch and Base Mount Contact Block



Base Mount
Cat. No. 800G-XBA



Latch Mount Screw Termination
Cat. No. 800G-XLSA

Contact	Base Mount		Latch Mount	
	Screw Termination		Screw Termination	Cable Termination
	Cat. No.		Cat. No.	Cat. No.
1 N.O. - 1 N.C.	800G-XBA		800G-XLSA	800G-XLC3A
2 N.O.	800G-XBM		800G-XLSM	800G-XLC3M
2 N.C.	800G-XBN		800G-XLSN	800G-XLC3N

Latch Mount and Base Mount Power Module*



Base Mount
Cat. No. 800G-DBG

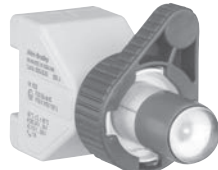

Latch Mount Screw Termination
Cat. No. 800G-DLSG

Color	Base Mount		Latch Mount	
	Screw Termination		Screw Termination	Cable Termination
	Cat. No.		Cat. No.	Cat. No.
White	800G-DBW		800G-DLSW	800G-DLC3W
Green	800G-DBG		800G-DLSG	800G-DLC3G
Red	800G-DBR		800G-DLSR	800G-DLC3R
Yellow	800G-DBY		800G-DLSY	800G-DLC3Y
Blue	800G-DBB		800G-DLSB	800G-DLC3B

Note: Cable termination length is three meters.

Power Module with Contact Block*



Latch Mount
Cat. No. 800G-DBGXK

Color	Latch Mount	
	1 N.O.	1 N.C.
	Cat. No.	Cat. No.
White	800G-DLSWXK	800G-DLSWXL
Green	800G-DLSGXK	800G-DLSGXL
Red	800G-DLSRXK	800G-DLSRXL
Yellow	800G-DLSYXK	800G-DLSYXL
Blue	800G-DLSBXK	800G-DLSBXL

Note: For use with illuminated push button.

800G – XLS A

a b
a

Contact Block/Latch Type	
Code	Description
XB	Base mount
XLS	Latch mount with screw termination
XLC3	Latch mount with 3 m (9.84 ft) cable termination

b

Contact Configuration	
Code	Description
A	1 N.O. - 1 N.C.
M	2 N.O.
N	2 N.C.

800G – DB G

a b
a

Power Module/Latch Type	
Code	Description
DB	Base mount
DLS	Latch mount with screw termination
DLC3	Latch mount with 3 m (9.84 ft) cable termination

b

Color	
Code	Description
W	White
G	Green
R	Red
Y	Yellow
B	Blue

* Bul. 800G LED modules can only be powered from dry contact circuits (with no leakage current in the OFF state).

800G – DB G XK

a b c
a

Power Module/Latch Type	
Code	Description
DB	Base
DLS	Latch mount with screw termination
DLC3	Latch mount with 3 m (9.84 ft) cable termination

b

Color	
Code	Description
W	White
G	Green
R	Red
Y	Yellow
B	Blue

















c

Contact Configuration	
Code	Description
XK	1 N.O.
XL	1 N.C.

* Bul. 800G LED modules can only be powered from dry contact circuits (with no leakage current in the OFF state).

Accessories

	Description	Pkg. Qty.	Cat. No.
	1/2 in. NPT Conduit Hub	1	800G-ACH1
<i>Cat. No. 800G-ACH2</i>	3/4 in. NPT Conduit Hub	1	800G-ACH2
	M20 Plastic Cable Gland (6...12 mm)	10	800G-ACG1
<i>Cat. No. 800G-ACG1</i>			
	M25 Plastic Cable Gland (13...18 mm)	10	800G-ACG3
<i>Cat. No. 800G-ACG3</i>			
	M20 Metal Cable Gland	10	800G-ACG5
<i>Cat. No. 800G-ACG5</i>			
	M20S Metal Cable Gland	10	800G-ACG7
<i>Cat. No. 800G-ACG7</i>			
	M25 Metal Cable Gland	10	800G-ACG6
	Earth Bracket	10	800G-AEB
<i>Cat. No. 800G-AEB</i>			
	Earth Plate 1 M20	10	800G-AEP1
<i>Cat. No. 800G-AEP1</i>			
	Earth Plate 2 M20	10	800G-AEP2
<i>Cat. No. 800G-AEP2</i>			
	Earth Plate M25	10	800G-AEP3
<i>Cat. No. 800G-AEP3</i>			
	M20 Stopping Plug	10	800G-AM20P
<i>Cat. No. 800G-AM20P</i>			
	M25 Stopping Plug	10	800G-AM25P
<i>Cat. No. 800G-AM25P</i>			

	Description	Pkg. Qty.	Cat. No.
	Mounting Nut	10	800G-AMN1
<i>Cat. No. 800G-AMNI</i>			
	10-printed push button inserts: Green "START"	10	800G-APC1
	10-printed push button inserts: Green "ON"	10	800G-APC2
	10-printed push button inserts: Green "I"	10	800G-APC3
	10-printed push button inserts: Red "STOP"	10	800G-APC4
	10-printed push button inserts: Red "OFF"	10	800G-APC5
	10-printed push button inserts: Red "O"	10	800G-APC6
<i>Cat. No. 800G-APC_</i>			
	Mounting Ring Wrench	10	800G-AW1
<i>Cat. No. 800G-AW1</i>			
	90 mm yellow legend plate for E-Stop	10	800G-AEL90
<i>Cat. No. 800G-AEL90</i>			
	Flange set for connecting 2 enclosures	—	800G-AFS
<i>Cat. No. 800G-AFS</i>			
	Locking cover with 30 mm hole for securement by bezel	—	800G-ALCB
	White color cap insert	10	800G-ACC1
	Black color cap insert	10	800G-ACC2
	Green color cap insert	10	800G-ACC3
	Red color cap insert	10	800G-ACC4
	Yellow color cap insert	10	800G-ACC6
<i>Cat. No. 800G-ACC_</i>			
	Contact block and power module ID blank label	10	800G-ACC7
<i>Cat. No. 800G-ACC7</i>			
	Black Hole Plug	—	800G-N2
<i>Cat. No. 800G-N2</i>			

Hazardous Location Push Buttons

Accessories

Legend Plate

Type	Description	Legend Plate without Text*	Legend Plate with Text*
		Cat. No.	Cat. No.
Legend plate frame with adhesive back legend plate, 30 x 4 mm*	Silver background with black legend text	800G-11SE100	800G-11SxxxxK
Adhesive back legend plate, 30 x 4 mm	Silver background with black legend text	800G-17SE100	800G-17SxxxxK

Legend Frame

Type	Description	Cat. No.*
Legend plate frame — snap-on, 30 x 4 mm*	Legend plate frame	800G-110

* Not available for mushroom push buttons.

* Minimum order quantity of 5.

800G – 11 S E 166 K
 a b c d e

a

Type	
Code	Description
11	Legend plate and frame
17	Legend plate only

c

Language	
Code	Description
E	English
F	French
G	German
T	Italian
S	Spanish
U	Universal symbol

d

Legend Identification	
Refer to page 10-206	

b

Insert Color	
Code	Description
S	Silver background with black legend text

e

Type	
Code	Description
K	0.080 size font



Legend Frame
Cat. No. 800G-110

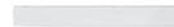

Adhesive Back Legend Plate
Cat. No. 800G-17SE100

Special Engraving

Besides the standard text and symbols listed on page 10-206, special legend plates are readily available.

To order:

- Select font code from table below.
- Specify desired text (please reference table below for restriction on characters and number of lines).

Type of Legend	Size	Font Size	Font Code	Approximate Size	Max. Characters/Line	Max. Number of Lines	Example	Example (Legend Plate with Frame)
Legend Plate	30 x 4 mm	Small	K	SAMPLE	19	1	800G-17SE100K STARTER	800G-11SE100K STARTER



Legend Plates, Continued

Type	Description	Legend Plate without Text*	Legend Plate with Text*
		Cat. No.	Cat. No.
Enclosure identification label, 50 x 15 mm	Silver background with black legend text	800G-AEL	800G-AEL_

* Minimum order quantity of 5.

800G – AEL S LINE 1 , LINE 2 , LINE 3

a b c d e

a

Insert Color	
Code	Description
AEL	Enclosure identification label with silver background and black text

b

Font Size	
Code	Description
S	0.10 size font
L	0.14 size font

c, d, e

Customized Text
Example of customer specified text based on max. characters per line and max. number of lines. When separated by a comma, the following text is to be engraved on the next line.



Blank Enclosure Identification Label
 Cat. No. 800G-AEL

Special Engraving

To order:

- Select desired font code table below (notes the max. characters and max. no. of lines).
- Specify desired text (please reference table below for restriction on characters and number of lines).

Type of Legend	Size	Font Size	Font Code	Approximate Size	Max. Characters/Line	Max. Number of Lines	Example
Enclosure ID Label	50 x 15 mm	Standard	S	SAMPLE	25	3	800G-AELS MACHINE 1, L-R27
		Large	L	SAMPLE	19	2	800G-AELL MACH 1

Hazardous Location Push Buttons

Legend Texts

Universal

Marking	Suffix Number	Marking	Suffix Number
	U226	I-O-II	U234
	U227	I-II-III	U240
O	U228		U241
I	U229		U242
II	U230	III	U249
I-O	U232		U244
I-II	U233		U245
0-1-2	U285	I-O-I	U282

English

One-Word Marking

Marking	Suffix Number	Marking	Suffix Number
AUTO	E101	OFF	E163
CLOSE	E107	ON	E166
DOWN	E110	OPEN	E170
EMERGENCY STOP	E112	OUT	E173
FAULT	E113	POWER ON	E178
FAST	E114	PUSH-TO-TEST	E181
FORWARD	E120	RAISE	E182
HAND	E126	RESET	E186
HIGH	E129	REVERSE	E188
IN	E132	RIGHT	E191
INCH	E134	RUN	E193
JOG	E138	SLOW	E201
LEFT	E145	START	E208
LOW	E148	STOP	E212
LOWER	E152	UP	E223

Two-Word Marking

Marking	Suffix Number	Marking	Suffix Number
FOR-REV	E253	LEFT-RIGHT	E146
HAND-AUTO	E127	OFF-ON	E165
HIGH-LOW	E130	OPEN-CLOSE	E171
INCH-REVERSE	E135	RAISE-LOWER	E183
JOG-FOR	E255	SLOW-FAST	E204
JOG-REV	E256	START-STOP	E211
JOG-RUN	E142	UP-DOWN	E224

Three-Word Marking

Marking	Suffix Number	Marking	Suffix Number
FOR-STOP-REV	E254	LOW-OFF-HIGH	E150
FOR-OFF-REV	E261	RAISE-OFF-LOWER	E184
HAND-OFF-AUTO	E128	SLOW-OFF-FAST	E205
JOG-STOP-RUN	E144	SLOW-OFF-START	E207
		HAND-O-AUTO	E283

French

Marking	Suffix Number	Marking	Suffix Number
Auto	F101	Monter	F182
Fermer	F107	Arrière	F188
Descendre	F110	Droit	F191
Panne	F113	Régler	F198
Rapide	F114	Lent	F201
Avant	F120	Marche-Arrêt	F211
Avant-Arrêt-Arrière	F122	Hors Circuit	F244
Avant-Arrière	F124	En Circuit	F245
Manuel	F126	Hors	F246
Manuel-Auto	F127	En	F247
Manuel-Arrêt-Auto	F128	Hors-En	F248

French, Continued

Marking	Suffix Number	Marking	Suffix Number
Haut	F129	Hors Manuel	F249
Gauche	F145	En Manuel	F250
Bas	F148	Arrêt-Manuel	F251
Bas-Arrêt-Haut	F150	Demar. Man.	F252
Arrêt	F163	Av-Hors-Arr	F253
Arrêt-Marche	F165	Surcharge	F254
Marche	F166	M Forcee	F284
Ouvrir	F170	—	—

German

Marking	Suffix Number	Marking	Suffix Number
Zu	G107	Niedrig	G148
Ab	G110	Niedrig-Aus-Hoch	G150
Störung	G113	Senken	G152
Schnell	G114	Aus	G163
Vor	G120	Aus-Ein	G165
Vor-Aus-Zurück	G122	Ein	G166
Vor-Zurück	G124	Heben	G182
Hand	G126	Zurück	G188
Hand-Auto	G127	Rechts	G191
Hand-Aus-Auto	G128	Langsam	G201
Hoch	G129	Auf	G223
Links	G145	Betrieb	G243

Italian

Marking	Suffix Number	Marking	Suffix Number
Automatico	T101	Disinserito	T163
Chiudere	T107	Disins-Ins	T165
Discesa	T110	Inserito	T166
Disturbo	T113	Salita	T182
Rapido	T114	Indietro	T188
Avanti	T120	Destra	T191
Avanti-Disins-Indietro	T122	Preparare	T198
Avanti-Indietro	T124	Lento	T201
Manuale	T126	Marcia	T208
Manuale-Auto	T127	Marcia-Arresto	T211
Manuale-Disins-Auto	T128	Arresto	T212
Alto	T129	Aprire	T223
Sinistra	T145	In Servizio	T243
Basso	T148	Rotazione CW	T246
Basso-Disins-Alto	T150	Rotazione CCW	T247
Abbassare	T152	Emergenza	T248

Spanish

Marking	Suffix Number	Marking	Suffix Number
Cerrar	S107	Abrir	S170
Adelante	S120	Subida	S182
Adelante-Parada-Atrás	S123	Atrás	S188
Adelante-Atrás	S124	Derecha	S191
Manual	S126	Marcha	S208
Manual-Auto	S127	Marcha-Parada	S211
Izquierda	S145	Parada	S212
Bajada	S152	En Servicio	S243

Approximate Dimensions

Dimensions in millimeters (inches). Dimensions are not intended to be used for manufacturing purposes.

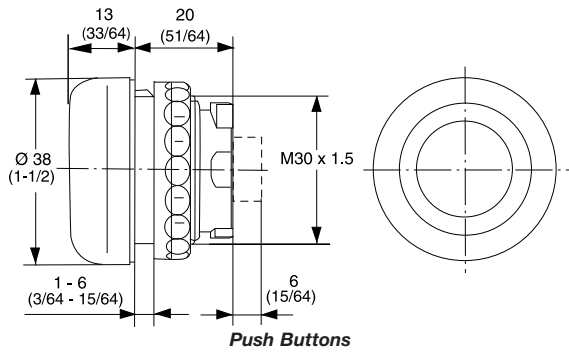

Push Buttons

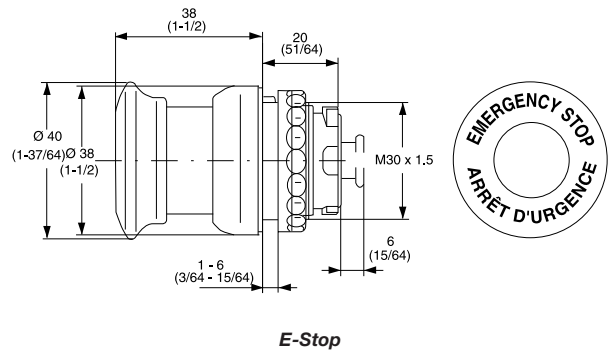

E-Stop

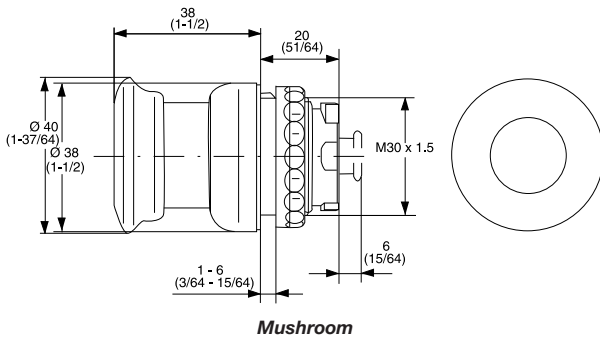

Mushroom

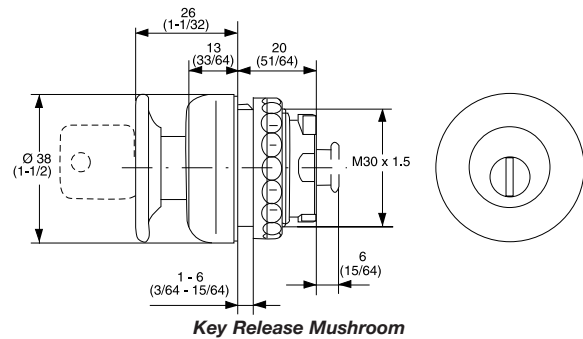

Key Release Mushroom

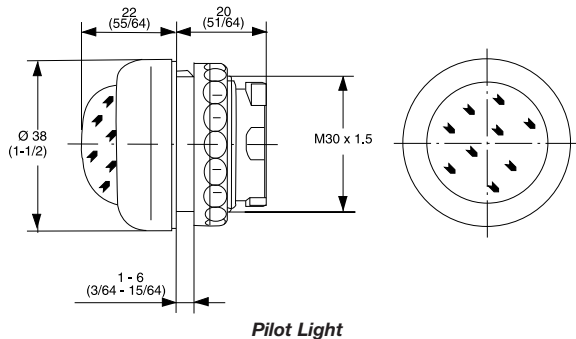

Pilot Light

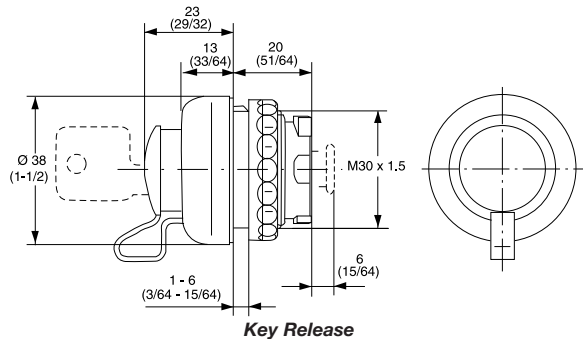

Key Release

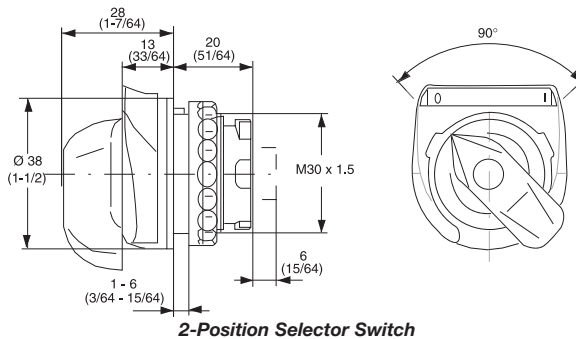

2-Position Selector Switch

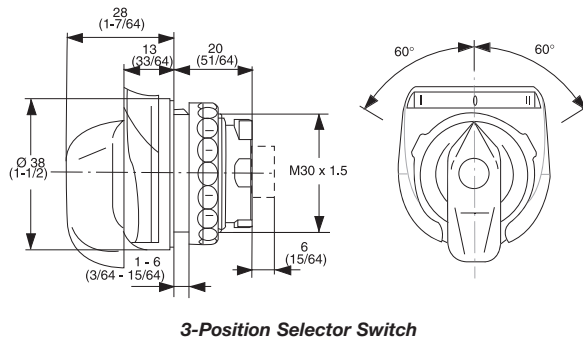

3-Position Selector Switch

Hazardous Location Push Buttons

Approximate Dimensions

Dimensions are in millimeters (inches). Dimensions are not intended to be used for manufacturing purposes.

Contact Block

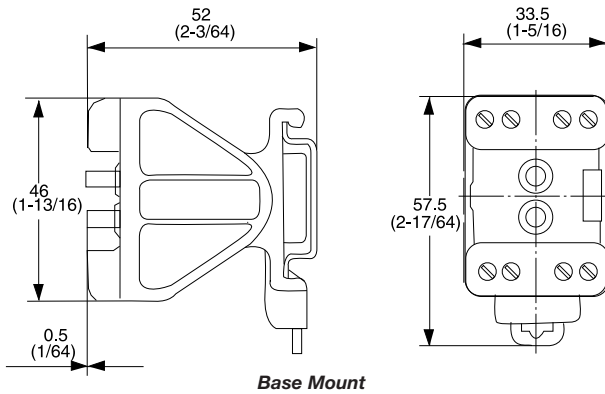
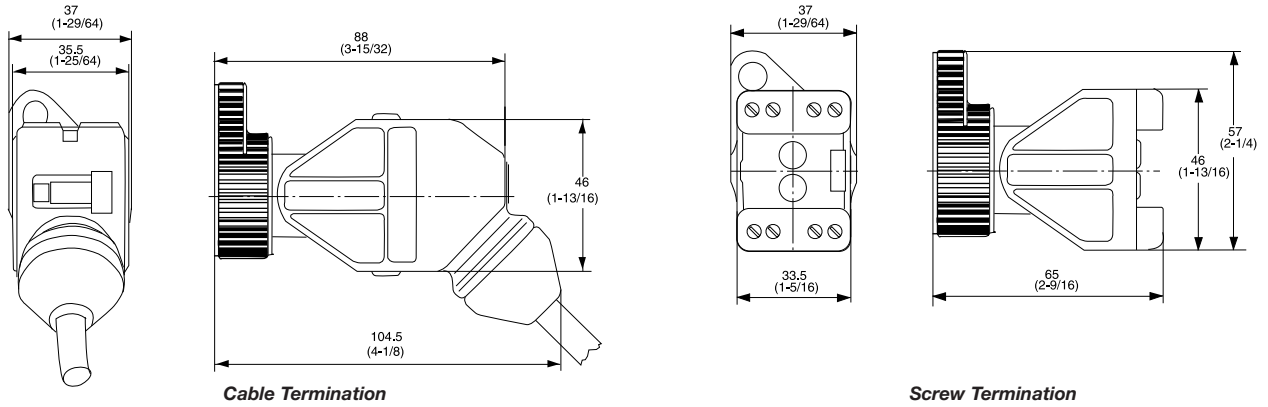

Power Module

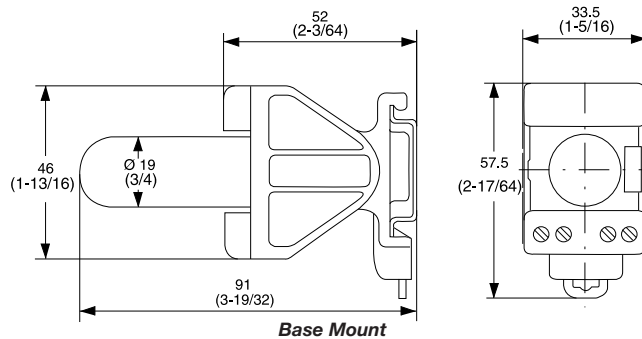
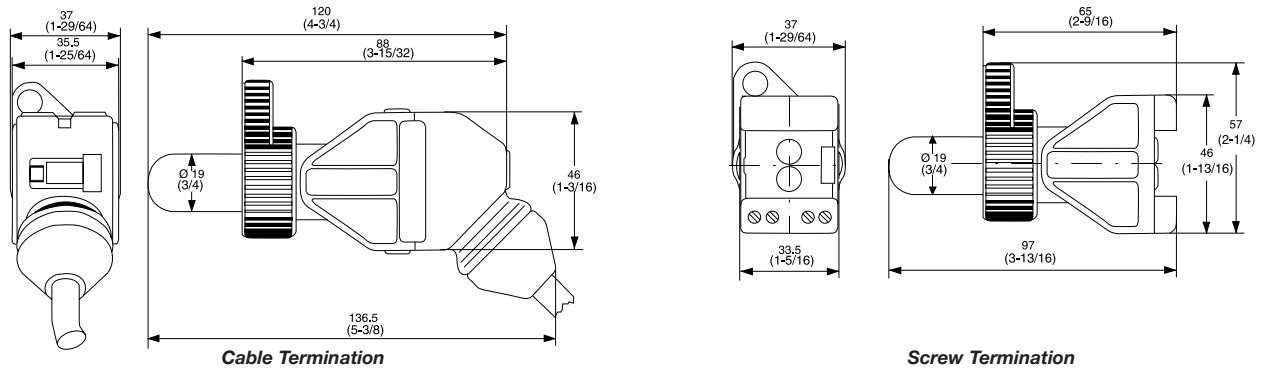

Dimensions are in millimeters (inches). Dimensions are not intended to be used for manufacturing purposes.

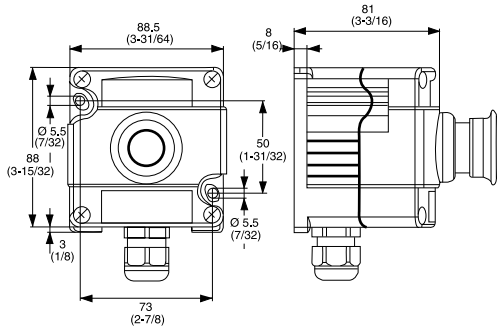

Single Unit

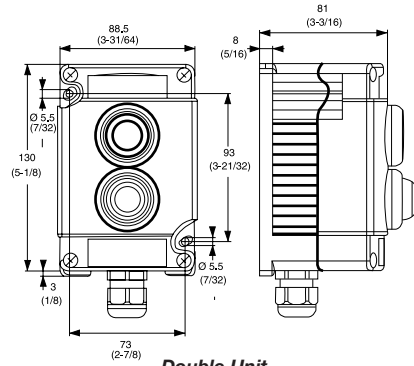

Double Unit

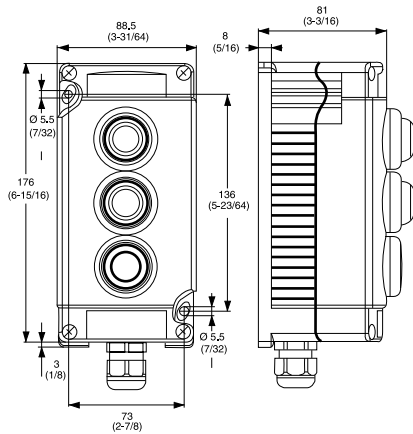

Triple Unit

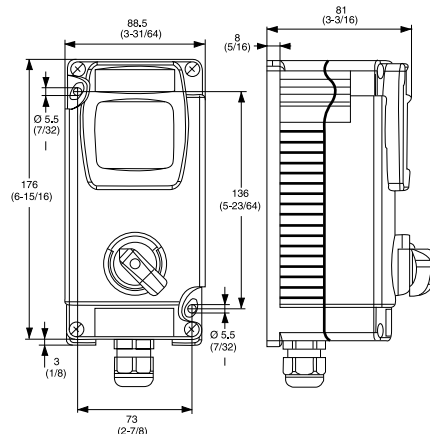

Measuring Instrument with Actuator

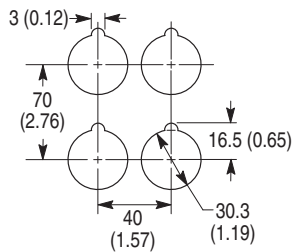

Vertical & Horizontal Spacing

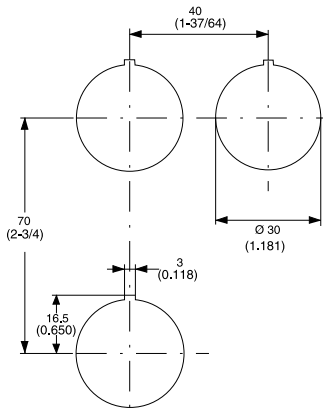

Mounting Dimension

Palm-Operated Push Buttons

Product Overview



Bulletin 800P — Palm-Operated Push Buttons

The Bulletin 800P palm-operated push button is designed for applications requiring electromechanical operation for safety, resistance to RFI, and an ergonomically sensitive design to reduce risk factors associated with cumulative trauma disorders. Bulletin 800P units with articulated operation offer reduced operating force over standard drive units by permitting the button head to tilt for added comfort and mechanical advantage. Bulletin 800P operators are intended for applications requiring two-hand control wiring, per OSHA standards.

Table of Contents

Product Selection 10-211
 Accessories..... 10-212
 Approximate Dimensions..... 10-213

Specifications*

Electrical Ratings		
Dielectric Strength	2200V for one minute	
Electrical Design Life Cycles	1 000 000 at maximum rated load 200 000 at maximum rated load (Logic Reed)	
Mechanical Ratings		
Vibration	10...2000 Hz 1.52 mm displacement (peak-to-peak) 10 G max.	
Shock	Mechanical shock at 1/2 cycle sine wave for 11 ms	
Contact Fragility	25 G 9 G 6 G	800T-XA1, -XA2, -XD1, -XD4, -XD2R, contact blocks 800T-XA, -XA4, -XD2, -XD3, -XAR, -XAV contact blocks 800T-XD1R No damage at 100 G all contact blocks
Degree of Protection	Type 1, 12, 4/13; watertight/oiltight 529 IP65	
Mechanical Design Life Cycles	Push Buttons	1 000 000 minimum
Contact Operation	Shallow Contact Block Logic Reed	Slow, double make and break Snap action
Typical Operating Forces	Articulated	800T-XD1 and 800T-XD4 contact blocks 3.7 lb maximum at center of button, 2.7 lb at perimeter
	Standard Drive	3.7 lb
Environmental		
Temperature Range	Operating Storage	+32...+131 °F (0...+55 °C) -40...+185 °F (-40...+85 °C)

Note: Operating temperatures at 0 °C (32 °F) are based on the absence of freezing moisture and liquids.

* Performance Data — See page Important- 3.

Standard Contact Ratings

(IEC 947-5-1) (NEMA ICS 2-125) Maximum continuous current I_{th} 10 A. Bulletin 800P units have control circuit ratings with 800T-XA1, -XD1, -XD4, -XA2, -XA, -XA4, -XD2, and -XD3 contact blocks as follows:

Maximum Operational Volts U_e	Utilization Category		Rated Operational Currents		
	IEC	NEMA	Volts U_e	Make ↔	Break ↔
AC 600	AC-15	A600	120...600 72...120 24...72	7200VA 60 A 60 A	720VA 720VA 10 A
DC 600	DC-13	Q600	28...600 24...28	69VA 2.5 A	

(See page 10-213 for 800T-XAR, -XD1R, -XD2R data.)

PenTUFF™ (Low Voltage) Contact Ratings

Minimum DC: 5V, 1 mA. Maximum thermal continuous current I_{th} 2.5 A AC/1.0 A DC. Bulletin 800P units with Cat. No. 800T-XAV contacts have ratings as follows:

Maximum Operational Volts U_e	Utilization Category		Rated Operational Currents		
	IEC	NEMA	Volts U_e	Make ↔	Break ↔
AC 300	AC-15	C300	120...300 0...120	1800VA 15 A	180VA 1.5 A
DC 150	DC-13	R150	24...150 0...24	28VA 1.0 A	



Product Selection
 Palm-Operated Push Buttons



Palm-Operated Flush Mount Button
 Cat. No. 800P-F2CA



Palm-Operated Surface Mount with Guard
 Cat. No. 800P-S2CG1A

Operation Type	Contact Type	Guard Option	Flush Mounting	Surface Mounting
			Cat. No.	Cat. No.
Articulated	1 N.O. - 1 N.C.	None	800P-F2CA	800P-S2C1A
		Guard	800P-F2CGA	800P-S2CG1A
	2 N.O. - 2 N.C.	None	800P-F2CB	800P-S2C1B
		Guard	800P-F2CGB	800P-S2CG1B
Standard Drive	1 N.O. - 1 N.C.	None	800P-F1CA	800P-S1C1A
		Guard	800P-F1CGA	800P-S1CG1A
	2 N.O. - 2 N.C.	None	800P-F1CB	800P-S1C1B
		Guard	800P-F1CGB	800P-S1CG1B

800P – S 1 C G 1 A
 a b c d e f

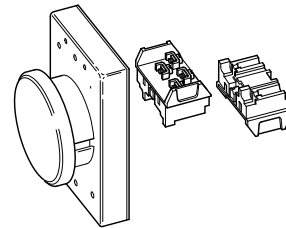

a

Operator Type	
Code	Description
F	Flush mount
S	Surface mount

b

Button Operation	
Code	Description
1	Standard drive
2	Articulated

c

Button Color	
Code	Description
C	Chrome
R	Red (painted)
Y	Yellow (painted)

d

Guard Option	
Code	Description
Blank	No guard
G	Side guard — yellow
H	Die cast — grey

e

Enclosure Openings	
Code	Description
Blank	No base*
1	Single hub
2	Double hub

f





Contact Black	
Standard	
Code	Description
A	1 N.O. - 1 N.C.
B	2 N.O. - 2 N.C.
PenTUFF (Low Voltage)	
Code	Description
AV	1 N.O. - 1 N.C.
BV	2 N.O. - 2 N.C.

* Only used for flush mounted operators.

Palm-Operated Push Buttons

Accessories

Accessories

	Description	Button Color	Cat. No.	Cat. No.
			Standard	Anti-Slip
 <p><i>Standard Button Cover</i> Cat. No. 800P-NCB</p> <p><i>Anti-Slip Button Cover</i> Cat. No. 800P-NCG1</p>	<p>Button Covers Button covers are used to reduce possible slipping due to fluids on the operator.</p>	Red	800P-NCR	800P-NCR1
		Black	800P-NCB	800P-NCB1
		Green	800P-NCG	800P-NCG1
		Yellow	800P-NCY	800P-NCY1
 <p><i>Side Guard</i> Cat. No. 800P-NBG1</p> <p><i>Die Cast Guard</i> Cat. No. 800P-NBG</p>	<p>Guards These guards prevent accidental activation of the button and protect it from damage. Note: Guards are required in most two hand safety applications (See OSHA and ANSI standards).</p>	Style	Color	Cat. No.
		Side	Yellow	800P-NBG1
		Die Cast	Grey	800P-NBG
		Die Cast	Yellow	800P-NBGY
 <p><i>Single Hub Base</i> Cat. No. 800P-B1</p> <p><i>Double Hub Base</i> Cat. No. 800P-B2</p>	<p>Bases The conduit hub(s) on these replacement mounting bases come with a 3/4 in. opening.</p>	Style	Cat. No.	
		Single Hub	800P-B1	
 <p><i>Standard Adapter</i> Cat. No. 800P-N150</p> <p><i>FS Adaptor</i> Cat. No. 800P-N4</p>	<p>Adaptors These adaptor flanges are used between the operator and the mounting base, when using a non-Allen-Bradley base.</p>	Enclosure	Cat. No.	
		Standard*	800P-N150	
 <p>Legend Plates</p>	<p>Legend Plates These legend plates can be mounted on the cover.</p>	FS	800P-N4	
		Marking	Cat. No.	
		Blank (Grey)	800P-X107*	
		Blank (Red)	800P-X129*	
		START	800P-X130	
		STOP	800P-X131	
		INCH	800P-X132	
		RUN	800P-X133	
RUN INCH	800P-X134			
TOP STOP	800P-X135			

* Horizontal mounting holes are 2-3/8 in. (60.3 mm) center-to-center. Vertical mounting holes are 4-1/2 in. (114.3 mm) center-to-center.

* To order with custom engraved text, add suffix **E** and supply text. One or two lines of text with maximum of 5 characters per line.



Palm-Operated Push Buttons

Modifications and Accessories/Approximate Dimensions

Modifications and Accessories

Contact Blocks

Packaged in a kit form for field installation. All necessary mounting hardware is provided with each contact block kit. Contact ratings are listed on page 10-210.

Note: It is recommended to mount no more than four contact blocks on any one unit (maximum two blocks deep).



Shallow Block



PentUFF (Low Voltage)
Contact Block



Logic Reed Block

Contact Type	Shallow Block*	PentUFF Block*	Logic Reed Block‡
	Cat. No.	Cat. No.	Cat. No.
1 N.O.	800T-XD1	800T-XD1V	800T-XD1R
1 N.C.	800T-XD2	800T-XD2V	800T-XD2R
1 N.O. - N.C.	800T-XA	800T-XAV	800T-XAR

Note: Contact blocks with normally closed contacts meet direct drive positive opening standard requirements.

‡ Logic Reed blocks can be physically mounted on a Bul. 800P operator, but this combination is not UL Listed for Class 1 Div 2 hazardous applications.

* For contact ratings, see page 10-4.

Approximate Dimensions

Dimensions in inches (millimeters). Dimensions are not intended to be used for manufacturing purposes.

Flush Mounting

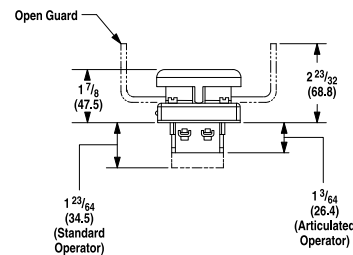
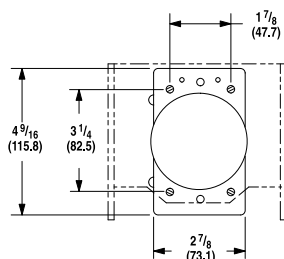

Surface Mounting

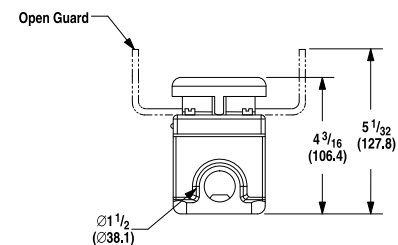
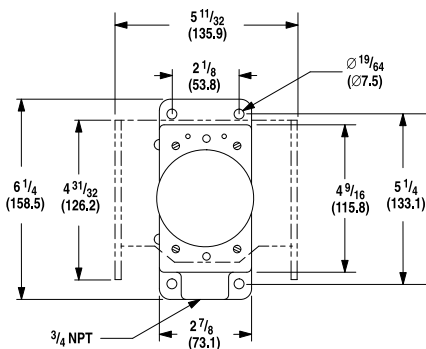

Die Cast Guard (800P-NBG or 800P-NBGY)

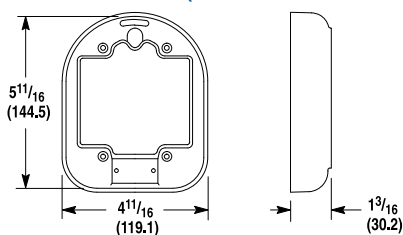

Cutout and mounting screw locations for a flush mounted cover

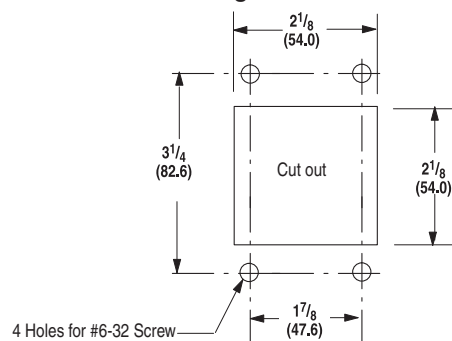



Bulletin 800Z — Zero-Force Touch Buttons™

Bulletin 800Z Zero-Force Touch Buttons are ideally suited for use in two-hand machine control systems and highly repetitive applications.

Ergonomic Design — The contour shape fits the palm of the hand for ease of operation and helps deter attempts to defeat two-hand control.

Zero Force to Operate — The electronic design with two interlinked capacitive sensors in offset planes provides increased sensitivity and good ability for distinguishing between a person's hand, even through most industrial gloves, versus most foreign objects.



ATTENTION: Not recommended for use in applications where there is high probability for exposure to liquid (e.g., cutting fluid) on the sensing surface area.

Table of Contents

Specifications..... this page
 General Purpose Line 10-215
 Heavy Industrial Line 10-216
 Quick Disconnect Cables 10-216
 Accessories..... 10-217
 Wiring Diagram 10-219
 Approximate Dimensions..... 10-220

Specifications

Mechanical Ratings

Description	General Purpose Line (800Z-G)	Heavy Industrial Line (800Z-H)
Mechanical Ratings		
Vibration Endurance	Tested @ 10 G, 1.52 mm displacement	
Mechanical Shock	Tested @ 100 G (mechanical durability)	
Degree of Protection	Type 4/4X/13 IP66 1200 psi Washdown	Type 4/13 IP66
Operating Force	Zero	
Electrical Ratings		
Input Voltage (Relay type)	Low Voltage: 10...40V DC, 20...30V AC Full Voltage (800Z-GF): 100...240V AC (+10%, -15%)	
Input Voltage (Solid-State type)	Low Voltage (800Z-GN/GP): 10...30V DC	
Electrical Design Life (Relay type)	Relay output 200 000 Operations @ 2 A inductive 4 A resistive	Relay output 150 000 Operations @ 5 A inductive 2.5 A resistive
Degree of Protection	IP2X	
Wire Range	#22...12 AWG (0.5...4 mm ²)	
Tightening Torque	9 lb•in (1 N•m)	
On-delay/Off-delay	Off 60 ms max. On 76 ms max.	
Current Draw (Solid-State type)	100 mA at 24V DC = 2.23 W (no external load)	
Environmental		
Temperature Range (Operating)	-25...+55 °C (-13...+131 °F)	
Temperature Range (Storage)	-40...+85 °C (-40...+185 °F)	
Humidity	95% RH from 25...50 °C (77...122 °F) (full operation)	
Materials		
Housing/Guard	Valox 357	
Gasket	BUNA-N	1/16 in. Cork-BUNA-N
Connector	Insulator material (micro connector) = nylon Insulator material (mini connector) = PVC	
Standards and Certifications		
Certifications	cULus, CE, C-TICK, CSA	
Standards Conformity	UL 508, CSA 22.2 No. 14, EN/IEC 60947-5-1, EN50081-2, EN61000-6-2, EN60954-1, EN60204-1	

Load Life Curves for General Purpose Product Line

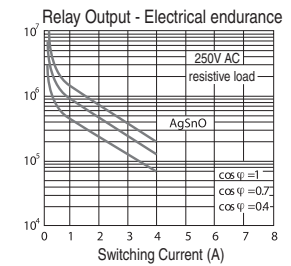
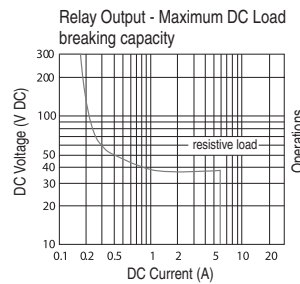

Load Life Curves for Heavy Industrial Line

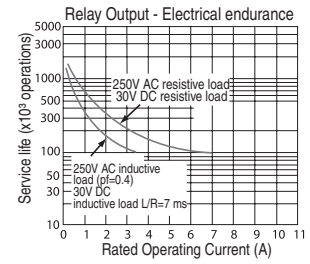
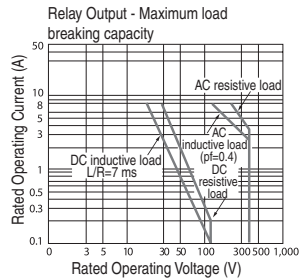

Applications Detail

LED Blink Rate	Diagnostic	Description
** ** *	Power Up	Device touched during power up. Device will resume 10 seconds after removal of hand.
*** ** *	Noise Detection	Device detected an unacceptable level of noise (>20 V/m). Device will resume once noise subsides.
**** ** *	Margin Detection	A conductive film is building up on the sensing surface. Device will resume once cleared.



General Purpose Line — Momentary Touch Buttons



General Purpose
 Cat. No. 800Z-GF2Q5



General Purpose
 Cat. No. 800Z-GL3Q5B

Mounting Hole Size	Input Voltage	Output Type	Electrical Connection	No Guard	Black Guard
				Cat. No.	Cat. No.
30.5 mm	100...240V AC	Relay Output	5-Pin QD	800Z-GF3Q5	800Z-GF3Q5B
			6 ft Cabled — 5-Wire	800Z-GF3Q65	800Z-GF3Q65B
	10...40V DC and 20...30V AC	Relay Output	5-Pin QD	800Z-GL3Q5	800Z-GL3Q5B
			6 ft Cabled — 5-Wire	800Z-GL3Q65	800Z-GL3Q65B
22.5 mm	100...240V AC	Relay Output	5-Pin QD	800Z-GF2Q5	800Z-GF2Q5B
			6 ft Cabled — 5-Wire	800Z-GF2Q65	800Z-GF2Q65B
	10...40V DC and 20...30V AC	Relay Output	5-Pin QD	800Z-GL2Q5	800Z-GL2Q5B
			6 ft Cabled — 5-Wire	800Z-GL2Q65	800Z-GL2Q65B

Use the configurator below to build a Bulletin 800Z touch button to suit your application.

800Z - G **L** **3** **065** **B**
 a *b* *c* *d*

a

Input Voltage and Output Type †	
Code	Description
Relay Output	
L	Input: 10...40V DC and 20...30V AC Output: relay
F	Input: 100...240V AC Output: relay
Transistor Output	
P	10...30V DC PNP (sourcing) output

b

Mounting Hole Size §	
Code	Description
2	22.5 mm
3	30.5 mm

c

Electrical Connection	
Code	Description
Sourcing Output *	
Q4	4-pin QD
064	6 ft (1.8 m) cabled
244	24 ft (7.2 m) cabled
Relay Output ‡	
Q5	5-pin QD
065	6 ft (1.8 m) cabled
245	24 ft (7.2 m) cabled

d

Guard Option	
Code	Description
Blank	No guard
B	Black guard
Y	Yellow guard

* These devices are transistor outputs.

‡ These devices have separate N.O. and N.C. output relays with a shared common.

† Safety relays should be used in conjunction with two relay output type Zero-Force Touch Buttons™ in 2-hand control applications. Order separately, safety relay 440R-D23171 for 24V, 440R-D23169 for 120V, 440R-D23168 for 240V.

§ 22.5 mm touch buttons use micro connector, 30.5 mm touch buttons use mini connector.

Zero-Force Touch Buttons™

Product Selection

Heavy Industrial Line — Momentary Touch Buttons



Heavy Industrial
Cat. No. 800Z-HF1



Heavy Industrial
Cat. No. 800Z-HL1Y

Button Type	Input Voltage	Output Type	Electrical Connection	No Guard	Yellow Guard
				Cat. No.	Cat. No.
Flush Mount	10...40V DC and 20...30V AC	Relay Output	Terminal Block	800Z-HL1	800Z-HL1Y
	100...240V AC	Relay Output	Terminal Block	800Z-HF1	800Z-HF1Y

Use the configurator below to build a Bulletin 800Z touch button to suit your application.

800Z – H L 1 Y
a *b* *c*

a

Voltage *	
Code	Description
L	Input: 10...40V DC and 20...30V AC Output: relay
F	Input: 100...240V AC Output: relay

b

Mounting Type *	
Code	Description
1	Flush mounting

c

Guard Option	
Code	Description
Blank	No guard
Y	Yellow guard

* Heavy industrial devices have an 8-position terminal block connection. See wiring diagrams on page 4-53 for details.

* Safety relays should be used in conjunction with two relay output type Zero-Force Touch Buttons in 2-hand control applications. Order separately, safety relay 440R-D23171 for 24V, 440R-D23169 for 120V, 440R-D23168 for 240V.

Quick Disconnect Cables



PD

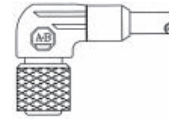

PD

889 D – F 4A C-2
a *b* *c* *d*

a

Mounting Hole Size	
Code	Description
D	22.5 mm (micro)
N	30.5 mm (mini)

b

QD Type	
Code	Description
F	Straight QD cable
R	Right angle QD cable

d

Cable Length/Type	
Code	Description
C-2	2 m (micro)
C-5	5 m (micro)
C-10	10 m (micro)
E-6F	6 ft. (mini)
E-12F	12 ft. (mini)
E-20F	20 ft. (mini)





c

Pin Style	
Code	Description
4A	4 pin
5A	5 pin ‡





‡ No right angle QD cable (micro) for 5-pin (Cat. No. 889D-R5A_).



Accessories — General Purpose

	Description		Cat. No.
 <p>Cat. No. 800Z-G3AG1 Cat. No. 800Z-G3AG2</p>	<p>Guards These guards help protect against accidental activation of the touch button surface and protect it from damage. Can be used for both the 22.5 mm and 30.5 mm mounted products.</p>	Yellow Plastic	800Z-G3AG1
		Black Plastic	800Z-G3AG2
 <p><i>Plastic Mounting Kit</i> Cat. No. 800Z-G2AH1</p>	<p>Mounting Ring Nut for 22.5 mm Holes Used on 22.5 mm devices.</p>	800Z-G2AH1	
 <p><i>Plastic Mounting Kit</i> Cat. No. 800Z-G3AH1</p>	<p>Mounting Ring Nut for 30.5 mm Hole Used on 30.5 mm devices.</p>	800Z-G3AH1	
 <p><i>Swivel Assembly</i> Cat. No. 60-2439</p>	<p>30.5 mm Swivel/Tilt Mounting Assembly This bracket allows you to orient the touch button in any position. It can be mounted on any vertical or horizontal surface. Compatible with 30.5 mm mounting only.</p>	2.25 in. (57 mm)	60-2681
		1.15 in. (29 mm)	60-2439
 <p>Cat. No. 800E-AHA1</p>	<p>30.5 mm to 22.5 mm Hole Size Adapter This adapter allows a 22.5 mm push button operator to be installed in a panel with existing 30.5 mm mounting holes.</p>	Metal	800F-AHA1
		Black Metal	800E-AHA2

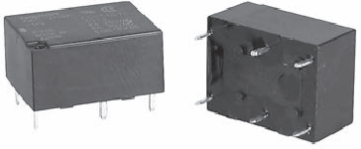
Accessories — Heavy Industrial

	Description		Cat. No.
 <p>Cat. No. 800Z-HAG1</p>	<p>Guard This guard helps protect against accidental activation of the touch surface and protects it from damage. Mounting screws are included.</p>	<p>Yellow Plastic</p>	<p>800Z-HAG1</p>
 <p><i>Single Hub Base</i> Cat. No. 800P-B1</p> <p><i>Double Hub Base</i> Cat. No. 800P-B2</p>	<p>Mounting Bases The heavy industrial line products mount directly on these bases. The conduit hub(s) come with a 3/4 inch opening.</p>	<p>1</p>	<p>800P-B1</p>
		<p>2</p>	<p>800P-B2</p>
 <p>Cat. No. 800P-N150</p>	<p>Adapter This adapter is used if mounting touch button onto a 4-1/2 in. x 2-3/8 in. (114.3 x 60.3 mm) enclosure pattern.</p>		<p>800P-N150</p>
 <p>Cat. No. 800Z-N12</p>	<p>Replacement Relay Note: Package quantity of 2.</p>	<p>10...264V</p>	<p>800Z-N12</p>
 <p>Cat. No. 800Z-HAH1</p>	<p>Replacement Screws</p>	<p>Guard-to-Base Mounting Note: package quantity of 4</p>	<p>800Z-HAH1</p>
		<p>Base Mounting Note: package quantity of 4</p>	<p>800Z-HAH2</p>

Wiring Diagrams — Touch Button Terminations

General Purpose Line

Electrical Connections: 10...40V DC and 20...30V AC Input Voltage (Relay Output); 100...240V AC Input Voltage (Relay Output)

Note: Separate N.O. and N.C. output relays with shared common.

5-Conductor Cabled (Relay Output)

For 800Z-GL _ _ _

For 800Z-GF _ _ _

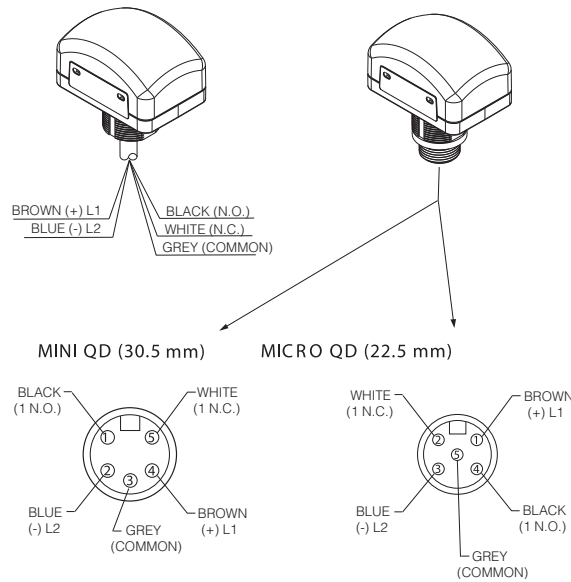

Electrical Connections: 10...30V DC Input Voltage (Transistor Output); 150 mA Max. per Circuit Output

4-Conductor Cabled

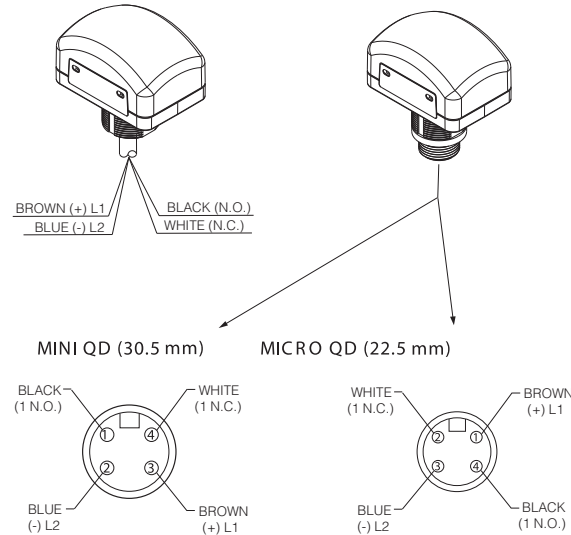

Heavy Industrial Line

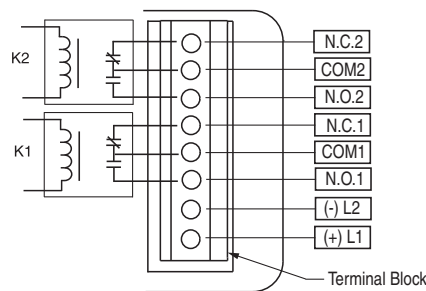

Zero-Force Touch Buttons™

Approximate Dimensions

Approximate Dimensions

Dimensions in inches (millimeters). Dimensions are not intended to be used for manufacturing purposes.

General Purpose

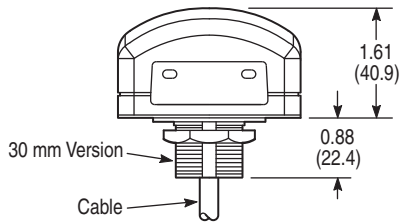
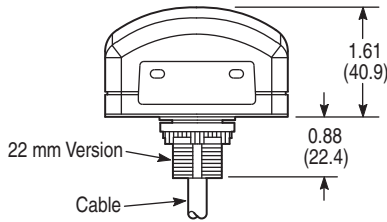
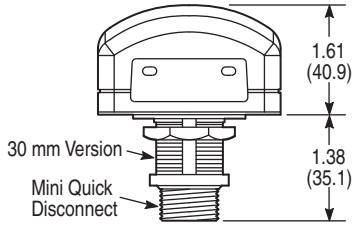
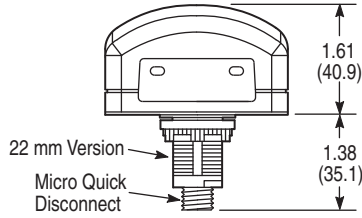
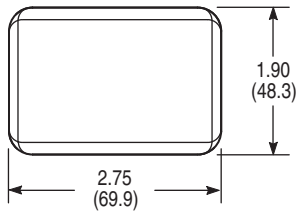

General Purpose With Guard

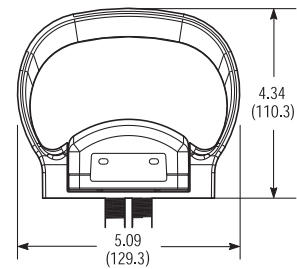
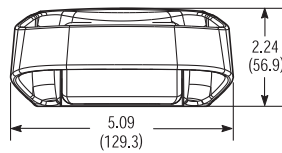

Heavy Industrial

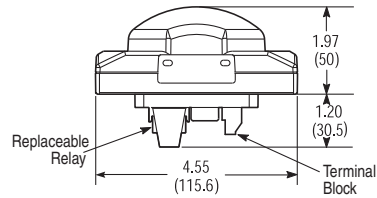
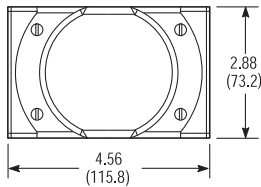

Heavy Industrial With Guard

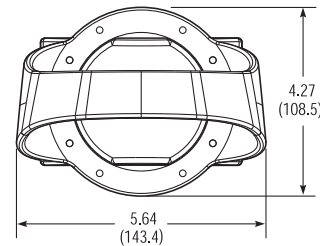
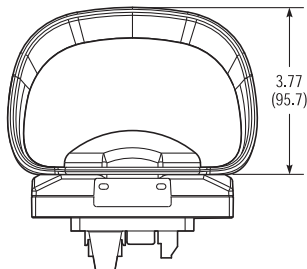

Cutout and Mounting Screw Locations for a Flush Mounted Cover

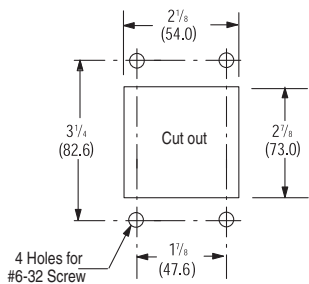

12 mm, 18 mm, 22 mm, and 30 mm Indicators

Product Overview/Selection

	<p>Bulletin 800L — 12, 18, 22, and 30 mm Indicators</p> <ul style="list-style-type: none"> • Economical, commercial-grade indicators • LED/strobe/incandescent • Shallow back-of-panel depth • Type 4/4X/13, watertight/oiltight (12 mm is Type 1) • 18, 22, and 30 mm devices are rated for use in Class 1 Div. 2 Groups A, B, C, D and Class 2 Div. 2 Groups F, G. 	<p>Table of Contents</p> <p>Product Selection this page Approximate Dimensions..... 10-222</p> <p>Standards Compliance UL 508</p> <p>Certifications cULus Listed (File No. E14840, Guide No. NKCR, NKCR7) EN60947-5-1 CSA C22.2, No. 14 CE Marked</p>
---	--	--

Specifications*

Mechanical Ratings		
Vibration	10...2000 Hz 1.52 mm displacement (peak-to-peak) max./10 G max	
Shock	1/2 cycle sine wave for 11 ms ≥ 25 G	
Degree of protection	12 mm: Type 1 18, 22, and 30 mm: Type 1/4/4X/12/13; watertight/oiltight IEC 529 IP66	
Environment		
Temperature range	Operating	-40...+131 °F (-40...+55 °C)
	Storage	-40...+185 °F (-40...+85 °C)
Humidity	50% at 104 °F (40 °C)	
Lamp Ratings		
Lamp life	Incandescent	5 000 Hrs.
	LED	100 000 Hrs.
	Strobe	1 000 000 Flashes
Flash frequency	Strobe	1...2 Hz

* Performance Data — See Important- 3.

Product Selection

12 mm Indicators

Color	6 in. Pigtail Leads		Terminals	
	24V DC	120V AC	24V DC	120V AC
	Cat. No.	Cat. No.	Cat. No.	Cat. No.
Amber	800L-12L24A	800L-12L10A	800L-12L24AS	800L-12L10AS
Blue	800L-12L24B	800L-12L10B	800L-12L24BS	800L-12L10BS
Clear	800L-12L24C	800L-12L10C	800L-12L24CS	800L-12L10CS
Green	800L-12L24G	800L-12L10G	800L-12L24GS	800L-12L10GS
Red	800L-12L24R	800L-12L10R	800L-12L24RS	800L-12L10RS

18 mm Indicators

Color	LED*			Incandescent	
	24V AC/DC	120V AC	240V AC	24V AC/DC	120V AC/DC
	Cat. No.	Cat. No.	Cat. No.	Cat. No.	Cat. No.
Amber	800L-18L24A	800L-18L10A	800L-18L20A	800L-18C24A	800L-18C10A
Blue	800L-18L24B	800L-18L10B	800L-18L20B	800L-18C24B	800L-18C10B
Clear	800L-18L24C	800L-18L10C	800L-18L20C	800L-18C24C	800L-18C10C
Green	800L-18L24G	800L-18L10G	800L-18L20G	800L-18C24G	800L-18C10G
Red	800L-18L24R	800L-18L10R	800L-18L20R	800L-18C24R	800L-18C10R

22 mm Indicators

Color	LED*			Incandescent		Strobe	
	24V AC/DC	120V AC	240V AC	24V AC/DC	120V AC/DC	24V AC/DC	120/240V AC
	Cat. No.	Cat. No.	Cat. No.	Cat. No.	Cat. No.	Cat. No.	Cat. No.
Amber	800L-22L24A	800L-22L10A	800L-22L20A	800L-22C24A	800L-22C10A	800L-22S24A	800L-22S10A
Blue	800L-22L24B	800L-22L10B	800L-22L20B	800L-22C24B	800L-22C10B	800L-22S24B	800L-22S10B
Clear	800L-22L24C	800L-22L10C	800L-22L20C	800L-22C24C	800L-22C10C	800L-22S24C	800L-22S10C
Green	800L-22L24G	800L-22L10G	800L-22L20G	800L-22C24G	800L-22C10G	800L-22S24G	800L-22S10G
Red	800L-22L24R	800L-22L10R	800L-22L20R	800L-22C24R	800L-22C10R	800L-22S24R	800L-22S10R

* LED color matches lens color specified. White LED supplied for clear selection.



www.ab.com/catalogs Preferred availability cat. nos. are bold.

Publication A117-CA001B-EN-P



12 mm, 18 mm, 22 mm, and 30 mm Indicators

Product Selection

Product Selection, Continued

30 mm Indicators

Color	LED*			Incandescent		Strobe	
	24V AC/DC Cat. No.	120V AC Cat. No.	240V AC Cat. No.	24V AC/DC Cat. No.	120V AC/DC Cat. No.	24V AC/DC Cat. No.	120/240V AC Cat. No.
Amber	800L-30L24A	800L-30L10A	800L-30L20A	800L-30C24A	800L-30C10A	800L-30S24A	800L-30S10A
Blue	800L-30L24B	800L-30L10B	800L-30L20B	800L-30C24B	800L-30C10B	800L-30S24B	800L-30S10B
Clear	800L-30L24C	800L-30L10C	800L-30L20C	800L-30C24C	800L-30C10C	800L-30S24C	800L-30S10C
Green	800L-30L24G	800L-30L10G	800L-30L20G	800L-30C24G	800L-30C10G	800L-30S24G	800L-30S10G
Red	800L-30L24R	800L-30L10R	800L-30L20R	800L-30C24R	800L-30C10R	800L-30S24R	800L-30S10R

* LED color matches lens color specified. White LED supplied for clear selection.

800L - 30 L 24 R
a b c d

Indicator Size		Illumination Type		Voltage		Lens Color	
Code	Description	Code	Description	Code	Description	Code	Description
12	12 mm	C	Incandescent	24	24V AC/DC*	R	Red
18	18 mm*	L	LED*§	10	120V AC	G	Green
22	22.5 mm	S	Xenon strobe*	20	240V AC‡	A	Amber
30	30.5 mm					B	Blue
						C	Clear

* 18 mm indicators are only available with LED or incandescent illumination. For 18 mm devices with 120V incandescent lamps, it is recommended that the lens is changed with lamp replacement.

‡ LED and Xenon strobe lamps are integral to indicators and are not field replaceable. Entire indicator must be replaced upon lamp failure.

‡ Incandescent illumination not available in 240V option. For 240V strobe, order voltage code 10 (Table c) as strobe is rated for both 120V/240V AC.

§ LED color will match lens color specified. White LED supplied for clear lens.

* 12 mm devices are only available with LED illumination (24V DC or 120V AC).

Replacement Parts

Replacement Lens Caps

Color	18 mm	22 mm	30 mm
Red	800L-N18R	800L-N22R	800T-N26R
Green	800L-N18G	800L-N22G	800T-N26G
Amber	800L-N18A	800L-N22A	800T-N26A
Blue	800L-N18B	800L-N22B	800T-N26B
Clear	800L-N18C	800L-N22C	800T-N26C

Replacement Lamps

Lamp Type	Voltage	ANSI No.	Cat. No.
Incandescent	24V AC/DC	757	800T-N157
	120V AC/DC	949	800T-N169

➤ LED and Xenon strobe lamps are integral to indicators and are not field replaceable. Entire indicator must be replaced upon lamp failure.

Approximate Dimensions

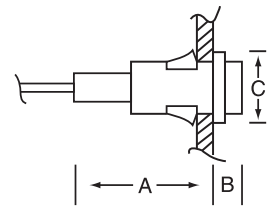
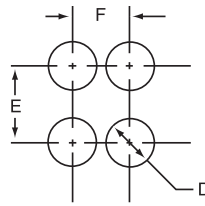
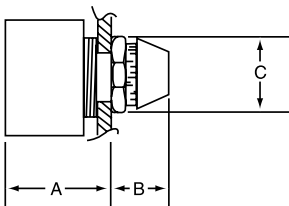

Indicator	A	B	C	D	E	F
	Inches (mm)					
12 mm	1-3/32 (27.8)	5/16 (7.9)	5/8 (15.8)	1/2 (12.7)	3/4 (19.0)	11/16 (17.5)
18 mm	1-21/64 (33.7)	57/64 (22.6)	1-1/32 (26.2)	3/4 (18.6)	2-9/32 (58.0)	1-1/8 (28.6)
22 mm	1-21/64 (33.7)*	57/64 (22.6)	1-7/32 (31.0)	15/16 (22.6)	2-9/32 (58.0)	1-8/32 (32.5)
30 mm	1-9/16 (39.7)*	1-9/64 (29.0)	1-19/32 (40.5)	1-13/64 (30.6)	2-9/32 (58.0)	1-29/32 (48.5)

* For devices with strobe illumination, Dimension A for 22 mm is 2-7/8 in. (73 mm) and for 30 mm devices it is 3-1/8 in. (79 mm).





Bulletin 800S — Standard Duty Stations

Bulletin 800S standard duty push button stations are used in control circuits. They offer compact size and dependable performance.

NEMA Type 1 general purpose stations have been designed for greater operating flexibility and ease of wiring. The cover of the station contains the entire contact mechanism. Wiring terminals are located in the base. Spring type, silver plated contacts connect the two assemblies. This unique construction will speed up installation and maintenance. Operating buttons can be rotated 90° to make them suitable for horizontal mounting. This change can be made in the field.

NEMA Type 4 enclosures are die cast aluminum. Standard stations are supplied with a 3/4 in. pipe tap at the bottom.

Table of Contents

Contact Ratings 10-225
 Accessories..... 10-225
 Approximate
 Dimensions..... 10-226

Pilot Lights

- Push button stations with pilot lights can operate on either 120V or 240V by changing connections. A red pilot lens is supplied.

Selector Switches

- All two-position Bulletin 800S standard duty selector switch stations can be changed to three-position in the field, and the three-position selector switches can be changed to two-position. Instructions for changing are included with each station.
- In addition to the standard marking, all selector switches are supplied with adhesive backed metal legend plates, marked as follows: OFF-ON, FOR-REV, HAND-AUTO, OPEN-CLOSE, HIGH-LOW, SUMMER-WINTER, SUMMER-OFF-WINTER, HIGH-OFF-LOW, OPEN-OFF-CLOSE, FOR-OFF-REV, HAND-OFF-AUTO.

Product Selection
Complete Assembled Stations



*Flush Mount Units fit a standard GEM or Handy Type Wall Box. Contact Symbol 3
 Cat. No. 800S-2AS*

Type 1 Flush Mount Unit* — Wall Box not included			
Legend Marking	Contact Symbol▶	Grey Painted Flush Plate	Stainless Steel Flush Plate
		Cat. No.	Cat. No.
START STOP	3	800S-2AS	800S-2ASQ

* Not rated for DC operation.



Cat. No. 800S-2SAP



Cat. No. 800S-2SCM

Momentary Contact Buttons and Pilot Light — 120V or 240V, Type 1.			Maintained Contact Buttons — Type 1		
Legend Marking	Contact Symbol▶	Cat. No.	Legend Marking	Contact Symbol▶	Cat. No.
No Legend START STOP	6	800S-2SAP	No Legend ON OFF	7	800S-2SCM
			No Legend START STOP	7	800S-2SBM

▶ Contact Symbols

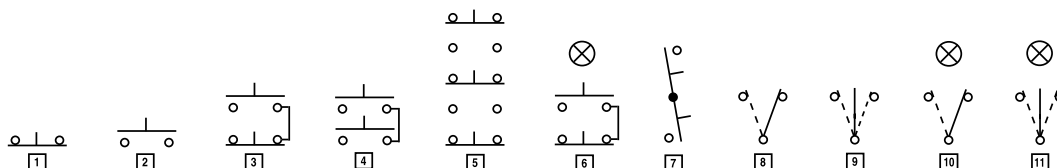

Bulletin 800S
Standard Duty Stations
 Product Selection

Complete Assembled
 Stations, Continued



Cat. No. **800S-R3SX**



Cat. No. **800S-R2SXP**

Selector Switches — Type 1				Selector Switch and Pilot Light — 120V or 240V, Type 1			
Legend Marking	Operator Type	Contact Symbol➤	Cat. No.	Legend Marking	Operator Type	Contact Symbol➤	Cat. No.
OFF-ON	2-Position Selector Switch	8	800S-R2SX	No Legend OFF-ON	Pilot Light, 2- Position Selector Switch	10	800S-R2SXP
HAND-OFF-AUTO	3-Position Selector Switch	9	800S-R3SX	No Legend HAND OFF AUTO	Pilot Light, 3- Position Selector Switch	11	800S-R3SXP



Cat. No. **800S-2SA**



Cat. No. **800S-2SA4**

Momentary Contact Buttons		Contact Symbol➤	Type 1	Type 4 Die Cast Aluminum Enclosure **
Legend Marking	Contact Type		Cat. No.	Cat. No.
STOP	1 N.C.	1	800S-1SA	800S-1SA4
	1 N.O.	2	800S-1SAK	800S-1SAK4
START	—	2	800S-1SB	800S-1SB4
START STOP	1 N.O. - 1 N.C.	3	800S-2SA	800S-2SA4
	1 N.O. - 1 N.O.	4	800S-2SAK	800S-2SAK4
FOR REV	—	4	800S-2SB	800S-2SB4
OPEN CLOSE	—	4	800S-2SF	800S-2SF4
ON OFF	1 N.O. - 1 N.C.	3	800S-2SE	800S-2SE4
	1 N.O. - 1 N.O.	4	800S-2SEK	800S-2SEK4
RAISE LOWER	—	4	800S-2SD	800S-2SD4
UP DOWN	—	4	800S-2SC	800S-2SC4
FAST SLOW STOP	—	5	800S-3SF	—
FOR REV STOP	—	5	800S-3SA	—
OPEN CLOSE STOP	—	5	800S-3SD	—
RAISE LOWER STOP	—	5	800S-3SB	—
UP DOWN STOP	—	5	800S-3SC	—

* Not rated for DC operation.

** Flip levers permit attachment of lock without additional accessory.

➤ Contact Symbols

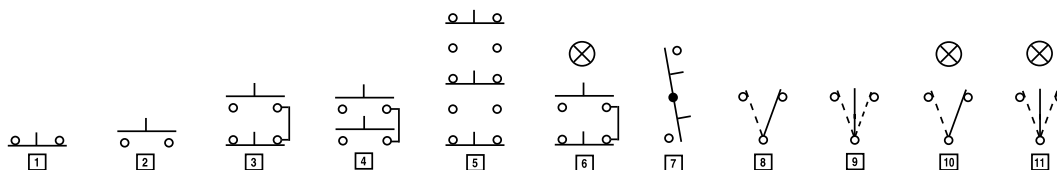

www.ab.com/catalogs Preferred availability cat. nos. are bold.



Contact Ratings



(IEC 337-1) (NEMA ICS 2-125) Maximum Continuous Current I_{th} 5 A. Bulletin 800S push button stations have control circuit ratings as follows:

Maximum Operational Voltage U_e	Utilization Category		Rated Operational Current		
	IEC	NEMA	Volts $U_e U_e$	Make	Break
				▶ ◀	◀ ▶
AC 600	AC-11	B600	480...600	3600VA	360VA
			240...480	3600VA	360VA
			120...240	30 A	3.0 A
DC 600	DC-11	P600	28...600	138VA	
			24...28‡	5.0 A	

‡ For applications below 24V and 24 mA, Bulletin 800T units with Logic Reed, sealed switch, or stackable sealed switch contact blocks are recommended.

Accessories

Complete Assembled Stations

	Description	Cat. No.
 <i>Cat. No. 800S-N90R</i>	Pilot Light Lens Red lens replacement cap.	800S-N90R
 <i>Cat. No. 800S-N60</i>	Lamp 120V lamp	800S-N60
 <i>Cat. No. 800S-N1</i>	Locking Attachments This device is used with extended push buttons or 2-position selector switches.	800S-N1
	This device is used with 3-position selector switches, to lock in the right or left position.	800S-N4

Standard Duty Stations

Approximate Dimensions

Approximate Dimensions and Shipping Weights

Dimensions in inches (millimeters). Dimensions are not intended to be used for manufacturing purposes.

Type 1 — General Purpose Enclosures

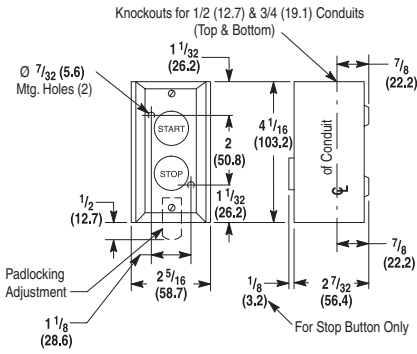

**One- and Two-Unit
Surface Mounting Stations**
Shipping Wt. 1 lb (0.45 kg)

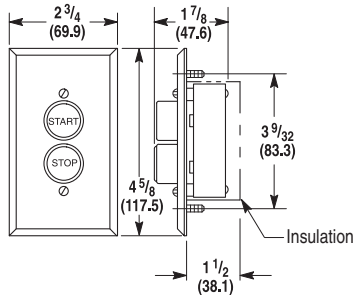

Three-Unit Surface Mounting Station
Shipping Wt. 1 lbs (0.45 kg)

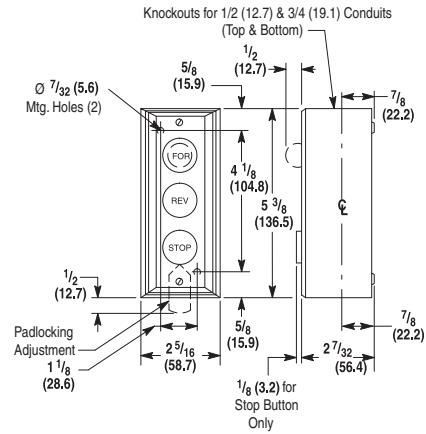

Two-Unit Flush Mounting Station
Shipping Wt. 2 lbs (0.91 kg)

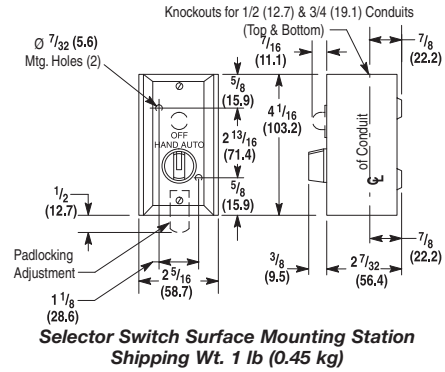

Selector Switch Surface Mounting Station
Shipping Wt. 1 lb (0.45 kg)

Type 4 — Watertight Enclosure

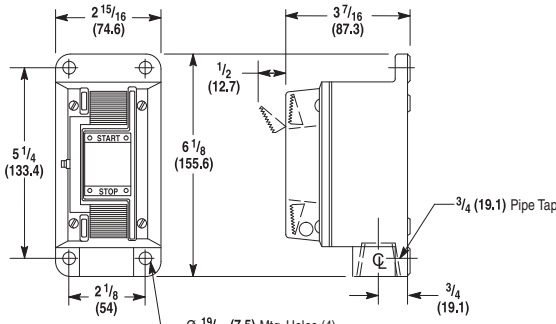

Shipping Wt. 3 lb (1.36 kg)